

# Personal Synthesis Workstation

## OptiMax 1001



**METTLER TOLEDO**



# Table of Contents

<b>1</b>	<b>Introduction</b>	<b>5</b>
1.1	Scope of Delivery .....	5
1.2	Check on arrival .....	7
<b>2</b>	<b>Safety Information</b>	<b>8</b>
2.1	Definition of signal warnings and symbols.....	8
2.2	Intended use .....	8
2.3	Product-specific safety.....	8
<b>3</b>	<b>Design and Function</b>	<b>11</b>
3.1	Overview.....	11
3.1.1	Touchscreen overview .....	13
3.2	Operating principle.....	14
3.2.1	Thermostat .....	15
3.3	Temperature modes .....	15
3.3.1	Tr mode .....	15
3.3.2	Tj mode .....	15
3.3.3	Distill / Reflux mode (Tj-Tr) .....	15
3.4	Safety system .....	16
3.4.1	Chemical safety .....	16
3.4.2	Intrinsic safety .....	16
3.4.3	Emergency program A .....	17
3.4.4	Emergency program E .....	17
3.5	Safety Relay .....	17
<b>4</b>	<b>Installation</b>	<b>19</b>
4.1	Installation requirements.....	19
4.2	Unpacking and transporting device .....	19
4.3	Connecting power to the device .....	19
4.4	Connecting water cooling.....	21
4.5	Connecting cryostat cooling .....	21
4.6	Connecting instrument purge gas.....	22
4.7	Purging the reactor with inert gas.....	23
4.8	Connecting touchscreen to OptiMax .....	23
4.9	Connecting stirrer purge gas.....	24
4.10	Connecting safeguard button to OptiMax.....	25
4.11	Assembling the Stirrer.....	25
4.12	Installing a Tr sensor.....	27
4.13	Installing a baffle .....	27
4.14	Installing a 1000 mL two-piece reactor .....	28
4.14.1	Openings of the 1000 / 500 mL two-piece reactor cover .....	29
4.15	Installing a 1000 mL one-piece reactor .....	29
4.15.1	Openings of the 1000 mL one-piece reactor cover .....	30
4.16	Using the rotation lock.....	30
4.17	Installing smaller two-piece reactors .....	31
4.17.1	Openings of the 250 mL two-piece reactor cover .....	31
4.18	Installing smaller one-piece reactors .....	32
4.18.1	Openings of the 500 mL one-piece reactor.....	32
4.18.2	Openings of the 250 mL one-piece reactor.....	32
4.19	Turn on Device .....	32
<b>5</b>	<b>Operation</b>	<b>33</b>
5.1	Change safety settings.....	33
5.1.1	Change safety temperature (T safe).....	33
5.1.2	Change reaction temperature limits (Tr) .....	33
5.1.3	Change range of jacket temperature (Tj) .....	34
5.1.4	Change T diff max.....	34
5.1.5	Change Rsafe .....	35
5.1.6	Change Rmax.....	35

5.2	Experiment.....	35
5.2.1	Select Reactor type.....	35
5.2.2	Start an experiment.....	36
5.2.3	Stirring.....	36
5.2.3.1	Change stirrer speed.....	36
5.2.3.2	Create a stirrer speed ramp.....	37
5.2.4	Add a time marker.....	37
5.2.5	Manual sampling.....	39
5.2.6	Manual add.....	39
5.2.7	End an experiment.....	40
5.2.8	Export data from a defined time frame.....	40
5.2.9	Export single experiments.....	41
5.3	Heating and cooling.....	41
5.3.1	Change Tj.....	41
5.3.2	Create a Tj Ramp.....	41
5.3.3	Change Tr.....	42
5.3.4	Create a Tr Ramp.....	42
5.3.5	Disable Tr.....	43
5.3.6	Create a distill / reflux operation.....	44
5.4	Trend graph.....	44
5.4.1	Enter trend graph screen.....	44
5.4.2	Select trend graph.....	44
5.4.3	Navigation in trend graphs.....	45
5.4.4	Add notes in trend graph view.....	45
5.4.5	Change color of trend graphs.....	46
5.4.6	Take snapshot.....	46
5.4.7	Export snapshot.....	46
5.4.8	Experiment time and time of day.....	46
5.5	Task sequence.....	47
5.5.1	Preparing a task sequence.....	47
5.5.2	Edit steps in a task sequence.....	48
5.5.3	End a task sequence.....	48
5.6	Settings.....	48
5.6.1	Change network settings.....	48
5.6.2	Change time settings.....	49
5.6.2.1	Change date and time.....	49
5.6.2.2	Change time zone.....	49
5.6.2.3	Change date format.....	50
5.6.2.4	Change time format.....	50
5.6.3	Change language.....	50
5.6.4	Change keyboard layout.....	51
5.6.5	System information.....	51
5.6.5.1	Export logfiles.....	52
<b>6</b>	<b>Maintenance</b> .....	<b>53</b>
6.1	Update Firmware.....	53
6.2	Checking the Reactor.....	53
6.3	Cleaning the Instrument.....	53
6.4	Replacing the valve plug of the bottom drain valve.....	53
6.5	Disassembling bottom drain valve for cleaning.....	54
6.6	Exchange PTFE seal in the stirrer adapter.....	55
6.7	Changing coolant.....	55
6.8	Disposal.....	56
<b>7</b>	<b>Troubleshooting</b> .....	<b>57</b>
<b>8</b>	<b>Accessories</b> .....	<b>58</b>
<b>9</b>	<b>Technical Data</b> .....	<b>60</b>
9.1	Thermostat.....	62
9.2	Reactors.....	62
9.3	Stirrer.....	63

9.4	Cooling .....	63
9.5	Purge gas.....	63









## 1 Introduction

The METTLER TOLEDO OptiMax™ 1001 is a reactor system for performing synthesis with a 250-mL, a 500-mL, or a 1000-mL glass reactor. The instrument is operated via the touchscreen.

- The reactor can be heated or cooled and its content stirred and refluxed.
- A Pt100 sensor measures the temperature of the reactor content for monitoring, temperature control and data capture.
- The integrated pH measurement system, when equipped with the appropriate electrode allows you to measure the pH value of the reactor content.
- You can export the acquired data to another program for further processing.

### 1.1 Scope of Delivery

The following items are included in the OptiMax 1001™ thermostat set:

Order number		Description	Quantity
		OptiMax 1001 thermostat	1
<b>51161883</b>		TFT touchscreen 7", 1 m cable	1
<b>11132570</b>		Protective cover for touchscreen	1
<b>30260369</b>		Safeguard button	1
<b>51191125</b>		PVC hose, soft, for reflux condenser, 5 m	1
<b>51161187</b>		PVC industrial hose for coolant, 15 bar, 2.5 m	2
<b>51192239</b>		PVC industrial hose for purge gas, 18 bar, 2 m	1
<b>51161186</b>		PVC hose for purge gas, 2 m	1
<b>51191373</b>		Y-piece for gas tubing	4

<b>51191916</b>		Reducing connector for purge gas tubing	3
<b>51190324</b>		Quick connect coupling for purge gas inlet	5
<b>51192126</b>		Hose clamp for PVC tube	4
<b>51191915</b>		Flow indicator for coolant	1
<b>51191914</b>		Knurled screw, M6 x 10 mm	4
<b>51162860</b>		Reactor block plug for bottom drain valve opening	1
<b>51192209</b>		O-ring for 51162860 plug, Ø 50.39 mm x 3.53 mm	1
<b>51161782</b>		Bubble counter	1
<b>51161603</b>		Magnetic bubble counter holder	1



<b>51162886</b>		Accessories holder set	1
<b>51192208</b>		Glass adapter ST19/26-GL14	2
<b>51190317</b>		Screw cap GL14, with aperture	2
<b>51103947</b>		Silicone rubber sealing ring for screw cap GL14, aperture 6 mm	2
<b>51191945</b>		Purge gas regulation valve	1
<b>51161099</b>		Lab bar, 600 mm x 14 mm	4
<b>51162690</b>		Overhead stirrer drive complete	1
		User Manual	1

If an item is missing, please contact your local support team.

## 1.2 Check on arrival

Check the following conditions once the package has arrived:

- The package is in good condition.
- The content shows no signs of damage (e.g. broken covers, scratches etc.)
- The content is complete (see [Scope of Delivery Page 5]).

If one condition is not fulfilled, please contact your local support.

## 2 Safety Information

This thermostat has been tested for the intended purposes described in this document. However, this does not absolve you from the responsibility of performing your own tests of the product supplied by us regarding its suitability for the methods and purposes you intend to use it for. You should therefore observe the following safety measures.







We, Mettler-Toledo GmbH, accept no liability whatsoever if you do not observe the following rules and safety notes for safe operation of the thermostat.

### 2.1 Definition of signal warnings and symbols

Safety notes are marked with signal words and warning symbols. These show safety issues and warnings. Ignoring the safety notes may lead to personal injury, damage to the instrument, malfunctions and false results.

<b>WARNING</b>	A hazardous situation with medium risk, possibly resulting in death or severe injury if not avoided.
<b>CAUTION</b>	A hazardous situation with low risk, resulting in minor or moderate injury if not avoided.
<b>NOTICE</b>	A hazardous situation with low risk, resulting in damage to the instrument, other material damage, malfunctions and erroneous results, or loss of data.
<b>Note</b>	(no symbol) for useful information about the product.

#### Meaning of safety symbols

	Electrical Hazard		Explosion		Burns / Hot Surface
	Rotating parts		Heavy load		General note

### 2.2 Intended use

The METTLER TOLEDO OptiMax™ 1001 is a reactor system for performing synthesis with reactor volumes up to 1000 mL.

The device is designed to be used in a laboratory environment and operated in a fume hood. All users should be trained to work in a laboratory and with this device.

Always operate and use your device in accordance with the instructions contained in this manual; use it only together with equipment specified in this documentation.

Any other type of use and operation beyond the limits of these technical specifications without the written consent from Mettler-Toledo GmbH is considered as not intended.

### 2.3 Product-specific safety



#### **WARNING**

##### **Risk of electric shock**

- 1 Make sure to plug the power cable supplied into a power supply outlet that is grounded. A technical fault could otherwise result in serious injury or death.
- 2 Only use the METTLER TOLEDO power supply cable and AC power adapter designed for your instrument.



## **⚠ WARNING**

### **Power failure**

A power failure can lead to explosion with possibly fatal consequences.

- Implement appropriate measures like an uninterruptible power supply (UPS).



## **⚠ WARNING**

### **Risk of explosion with critical reactions**

Performing critical reactions could lead to explosions.

- Perform a safety analysis before starting an experiment with high hazardous potential for example by using a Differential Scanning Calorimeter.



## **⚠ WARNING**

### **Electrostatic discharges through stirring the reaction mass**

The following conditions can form electrostatic charge:

- High flow rates (high stirrer speed) of nonpolar liquids with a high resistivity ( $>10^8$  Ohmmeter).
- Two-phase systems with suspended solids (e.g. after crystallization processes in nonconductive solvents or immiscible liquids.)
- Work under an inert gas (nitrogen or argon).



## **⚠ WARNING**

### **Risk of explosion due to damaged reactors**

Explosion of a reactor could cause serious injury.

- Check the reactor before each use for damage (scratches, formation of cracks).



## **⚠ CAUTION**

### **Hot parts when working above 50 °C**

Touching hot parts can cause burns.

- Do not touch the cover plate of the device, the fixing ring, the reactor covers, attachments of the reactor or the overhead stirrer if you work above 50 °C.



## **⚠ CAUTION**

### **Rotating parts of stirrer**

Rotating parts of a running stirrer may lead to injuries.

- 1 Do not touch rotating parts of a stirrer.
- 2 Do not wear loose clothing and make sure jewellery and long hair do not get entangled in the stirrer.



## **⚠ CAUTION**

### **Risk of injury due to heavy load**

You can injure yourself by carrying the instrument alone.

- Never try to carry the instrument alone. At least two people are needed to carry the instrument.



## NOTICE

### Wrong coolant used

High chloride concentration or some additives in the coolant can lead to corrosion of the thermostat.

- 1 Do not use solutions of NaCl, CaCl<sub>2</sub> or DW-Therm.
- 2 Check compatibility with the wetted parts of the coolant system.



## NOTICE

### Wrong connection or disconnection of cables

A wrong connection or disconnection of cables during operation could lead to instrument damage.

- 1 Before switching the device on, connect the cables of stirrers and sensors to their respective inputs and outputs.
- 2 Do not disconnect the cables while the instrument is operating.



## NOTICE

### Condensation of atmospheric moisture

The condensation of atmospheric moisture can cause corrosion of the instrument.

- 1 Always purge the instrument when it is in use. This removes any condensation that has formed.
- 2 Purge it with dry air, nitrogen or argon.



## NOTICE

### Thermal shock

Glass parts of the instrument or the reactor could get damaged.

- Do not pour cold liquids into hot glassware and vice versa.



## NOTICE

### Risk of reactor breakage when sealed hermetically

Hermetical sealing could lead to pressure build-up when using gas or when the reactor is heated.

- Make sure venting is always possible.

### 3 Design and Function

#### 3.1 Overview

Front view

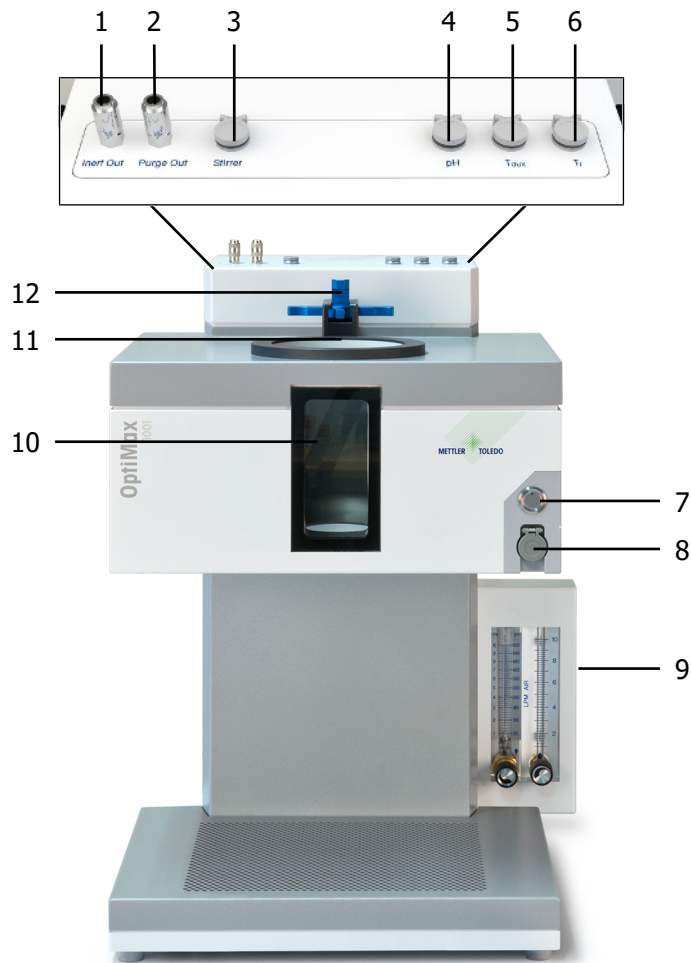

<b>1</b>	Inert out connection	<b>2</b>	Purge out connection
<b>3</b>	Stirrer connection	<b>4</b>	pH connection
<b>5</b>	T <sub>aux</sub> connection	<b>6</b>	Tr connection
<b>7</b>	Power Button	<b>8</b>	USB
<b>9</b>	Flow indicators	<b>10</b>	Reactor window (with back- and frontlight)
<b>11</b>	Opening for reactors	<b>12</b>	Locking device

## Back view

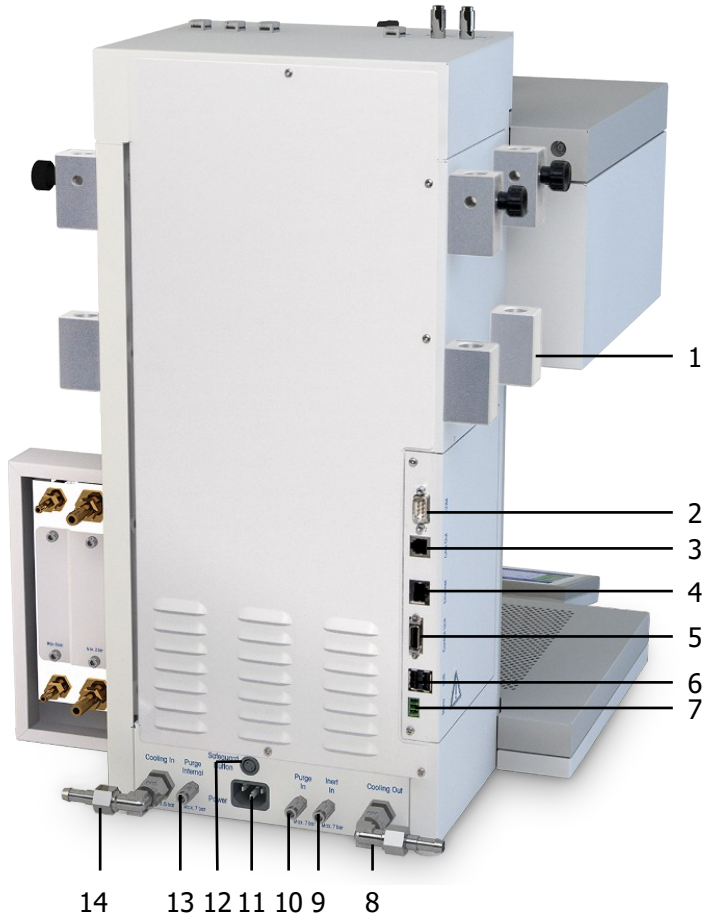

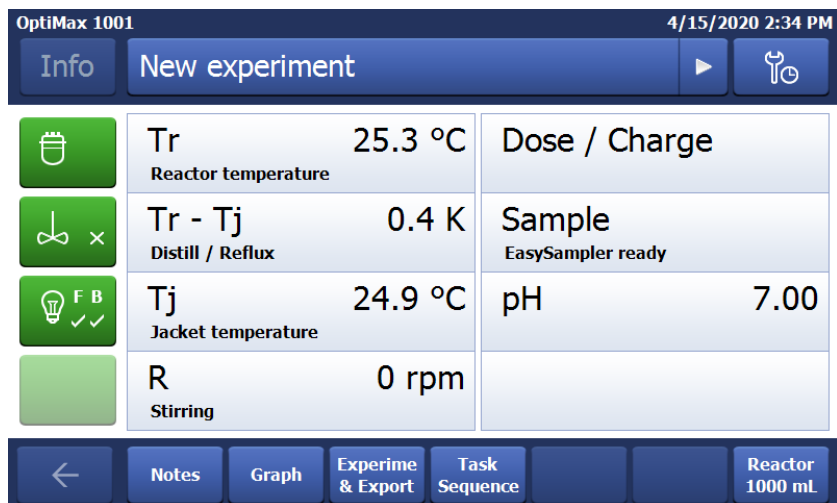

<b>1</b>	Holder for lab bars	<b>2</b>	RS232
<b>3</b>	Ethernet	<b>4</b>	CAN out
<b>5</b>	Control unit (Touchscreen) connection	<b>6</b>	USB (2x)
<b>7</b>	Safety relay	<b>8</b>	Coolant out
<b>9</b>	Inert in connection	<b>10</b>	Purge in connection
<b>11</b>	Power supply	<b>12</b>	Safeguard button connection
<b>13</b>	Purge internal connection	<b>14</b>	Coolant in

### 3.1.1 Touchscreen overview

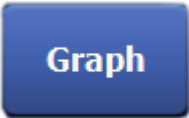

	Displays error messages and warnings
	Enables you to start, stop and pause a running experiment
	Brings you to the device management screen, where you can: <ul style="list-style-type: none"> <li>• Prepare connected dosing units</li> <li>• Configure the ECB outputs</li> </ul> On the bottom left you can get to the system settings: <ul style="list-style-type: none"> <li>• Network Settings</li> <li>• Time Settings</li> <li>• Language Settings</li> <li>• System information</li> </ul>
	Displays main screen or brings you back to main screen
	Switches stirrer on and off. Stirrer on controls the stirrer to 100 rpm
	Only available when an experiment is running. Used to set time back to zero
	Illuminates reactor (ticks mean light on, x means light off, f for frontlight and b for backlight)
	Lets you enter a note.

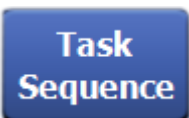
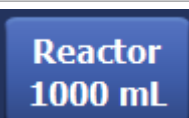
	Switches view to the trend graph viewer
	Allows you to start an experiment or export already finished experiments
	Allows you to create a sequence with up to 6 tasks
	Allows you to access the safety settings and change reactor types

### 3.2 Operating principle

The device consists of four modules:

- Electronic control unit
- Thermostat
- Measurement system
- Touchscreen

The touchscreen is used to control the device, perform experiments and managing data (storage and export of data).

For the following values the measurement system calculates the set value and acquires the actual value every 2 seconds:

- Temperature of the reaction mass ( $T_r$ )
- Temperature of the thermostat ( $T_j$ )
- Temperature of coolant ( $T_c$ )
- Stirrer speed ( $R$ )
- $T_{aux}$
- pH

These values are used for controlling the instrument and to trigger warnings and emergency programs.



### 3.2.1 Thermostat

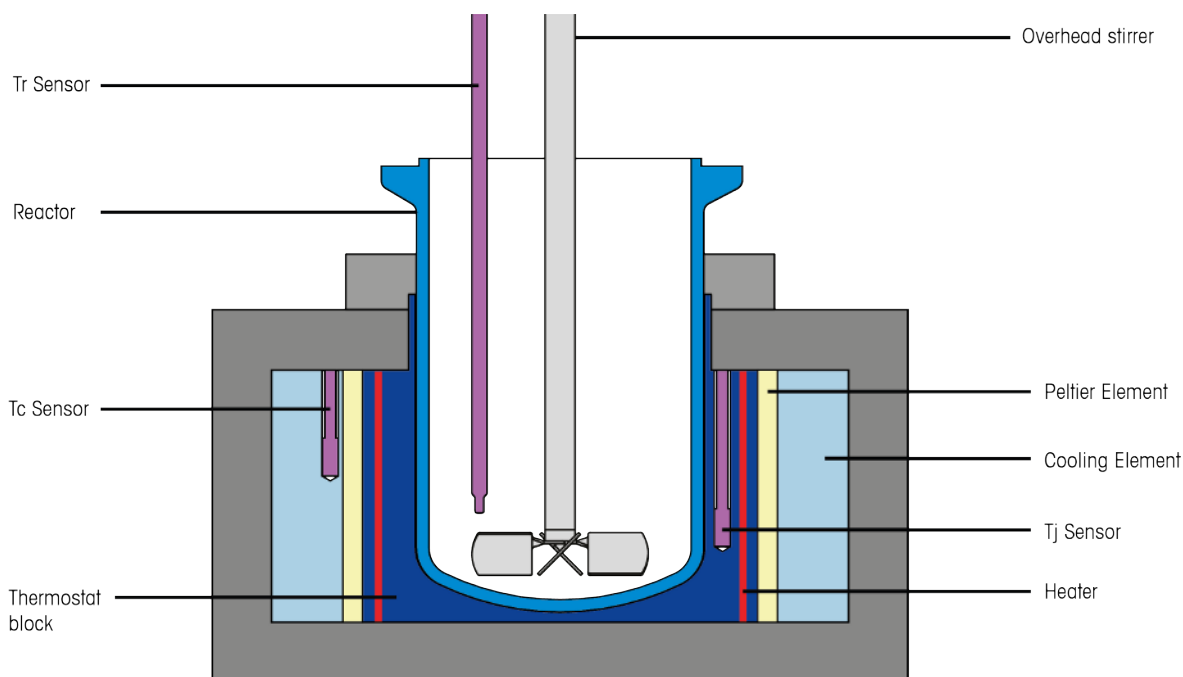

- The Tr sensor measures the temperature of the reactor contents.
- The Tj sensor measures the temperature of the reactor shell.
- The Tc sensor measures the temperature of the cooling element.

## 3.3 Temperature modes

### 3.3.1 Tr mode

The temperature of the reactor contents is controlled. Thereby Tr is held constant or changed with a ramp. Deviations of the temperature of the reactor contents from the set value (through heat of reaction) are compensated by appropriate correction of the thermostat temperature, i.e. the heat generated is dissipated.

### 3.3.2 Tj mode

The temperature of the thermostat is controlled. Tj is held at a specific value or changed with a temperature ramp.

### 3.3.3 Distill / Reflux mode (Tj-Tr)

Distill / Reflux mode can be used if you want to distill or reflux a solvent or a mixture of solvents, especially when the boiling point(s) are unknown. This mode ensures that when a boiling point is reached, the system will not continue to increase the jacket temperature but will hold the temperature when a certain difference in Tj-Tr is reached.

The value entered for the desired temperature difference between the thermostat and the reactor contents (Tj - Tr) is added to the measured temperature of the reactor contents (Tr) and gives the set value for the control of Tj. For this mode, you have to enter:

- the desired temperature difference, Tj - Tr,
- the upper limit of the jacket temperature, Tj end.

As a result, during the time when the solvent is not boiling, the temperature of the reactor contents, Tr, rises in accordance with the value entered for Tj - Tr. When the reaction mixture is boiling, Tr and hence also Tj remain approximately constant. As soon as Tj end is reached, the final (end) temperature is held.

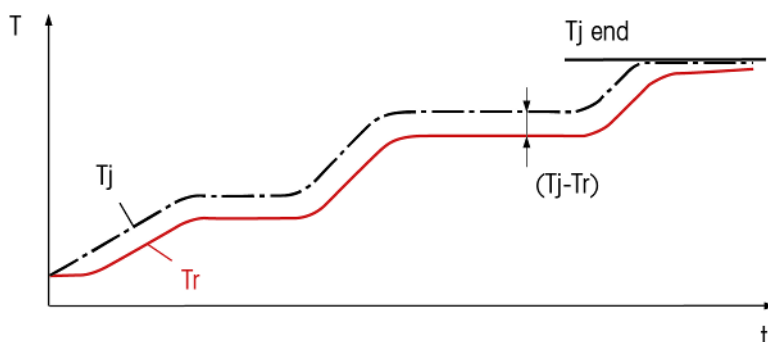

### 3.4 Safety system

#### Behavior of stirring in case of power outage or mechanical blockage

In case of a power outage the stirring will not continue after the power is back.

In case of a mechanical blockage the stirring will continue after removing the blockage.

#### 3.4.1 Chemical safety

The safety with chemical reactions is assured by monitoring the limit values of the temperatures, the stirrer speed and the measured values of the sensors.

You should define the limit values for each new application after careful consideration of all criteria.

##### Measures to ensure chemical safety

- Limitation of the  $T_j$  set value to  $T_j$  end in the distillation or reflux mode.
- Monitoring the limit values for  $T_r$ ,  $T_j$  and  $R_{max}$  defined by you; triggering emergency programs if limit values are exceeded.
- The safety temperature  $T_{safe}$  you have defined is used as set temperature for emergency program E
- Monitoring of the plausibility of your entries (prevention of typing errors that could have serious consequences).
- Implementation of additional measures with the safety relay, e.g. an external alarm system with visual and/or audio signals or the activation of additional safety functions such as electromagnetic valves. (You have to implement the measures.)
- Manual triggering of an emergency cooling by pressing the safeguard button.

#### 3.4.2 Intrinsic safety

Safe operation is assured by continuously checking all the functions of the system.

For every instrument configuration, you are responsible for ensuring that the entire system is safe in case of a power-failure. Ensure that any reaction in progress can not run away.

##### Measures to ensure intrinsic safety

###### Electronics

- Monitoring the microprocessor for breakdown (watchdog).
- Monitoring of the stirrer motor.

###### Software

- Self-test of the microprocessor system after switching on.
- Monitoring all measured values for plausibility and failure.
- Restriction of the temperature difference " $T_j - T_r$ " to maximum 60 K in the  $T_r$  and distillation / reflux mode to avoid glass breakage.
- Error recognition and triggering of emergency programs.

### 3.4.3 Emergency program A

As long as emergency program A is active, errors which trigger this program cannot be reset, i.e. you have to switch off the instrument and rectify the error. An exception is the emergency program "Tc higher than Tc max". The cause for an emergency program A will most likely be a hardware issue that needs to be fixed.

#### Error causes and measures

Error causes	Measures to take
No connection	Switch off the instrument and restart it.
A/D converter defective	Call METTLER TOLEDO Service.
Power PIC error	Call METTLER TOLEDO Service.
Tj sensor defective	Call METTLER TOLEDO Service.
Tc sensor defective	Call METTLER TOLEDO Service
Tc > Tc max (The temperature of the coolant, Tc, is higher than the defined safety limit value ,Tc max)	Check the flow rate of the coolant. Press Reset, when Tc is lower than Tc max again and continue the interrupted experiment.

### 3.4.4 Emergency program E

Errors which trigger emergency program E can be reset, i.e. you can continue the experiment when you have rectified the error.

The cause for an emergency program E will most likely be an application fault that can be fixed by the user.

#### Error causes and measures

Error causes	Measures to take
Tr sensor defective or not connected	Connect the Tr sensor or connect a new one.
Tr > Tr max (The temperature of the reactor contents, Tr, is higher than the defined safety limit value Tr max)	<ol style="list-style-type: none"> <li>1 Tap <b>Reset</b>.</li> <li>2 Wait until Tr &lt; Tr max.</li> <li>3 Continue the experiment.</li> </ol>
Tr < Tr min (The temperature of the reactor contents, Tr, is lower than the defined safety limit value Tr min)	<ol style="list-style-type: none"> <li>1 Tap <b>Reset</b>.</li> <li>2 Wait until Tr &gt; Tr min.</li> <li>3 Continue the experiment.</li> </ol>
Tj > Tj max (The temperature of the thermostat, Tj, is higher than the defined safety limit value Tj max)	<ol style="list-style-type: none"> <li>1 Tap <b>Reset</b>.</li> <li>2 Wait until Tj &lt; Tj max</li> <li>3 Continue the experiment.</li> </ol>
Tj < Tj min (The temperature of the thermostat, Tj, is lower than the defined safety limit value Tj min)	<ol style="list-style-type: none"> <li>1 Tap <b>Reset</b>.</li> <li>2 Wait until Tj &gt; Tj min.</li> <li>3 Continue the experiment.</li> </ol>
The safeguard button is pressed during an active ramp	<ol style="list-style-type: none"> <li>1 Release the safeguard button.</li> <li>2 Continue the experiment.</li> </ol>
The stirrer motor cannot reach the set speed for more than 3 minutes	<ol style="list-style-type: none"> <li>1 Reduce the speed.</li> <li>2 Check the viscosity.</li> <li>3 Continue the experiment.</li> </ol>

## 3.5 Safety Relay

The emergency relay is thought for connecting an optical or visual alarm. In case no emergency program is triggered, pins 1 and 2 are connected. As soon as an emergency program is triggered, the relay switches and pins 2 and 3 are connected. The safety relay is specified for 30 VDC / 1 A.

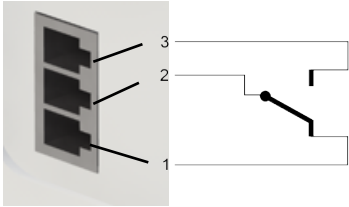

Relay switched off: contact between pin 1 and pin 2

Relay switched on: contact between pin 2 and pin 3 (Meaning an emergency program has been triggered).

## 4 Installation

### 4.1 Installation requirements

- The device should be installed in a fume hood.
- Make sure there is enough space (about 10 cm) between the ventilation slots at the back side of the instrument and any other object or the wall.
- Make sure you install the device in accordance with the [technical data Page 60].

#### Site requirements

The instrument has been developed for indoor operation in a well-ventilated area. Avoid the following environmental influences:

- Conditions outside of the ambient conditions specified in the technical data
- Powerful vibrations
- Direct sunlight
- Corrosive gas atmosphere
- Explosive atmosphere of gases, steam, fog, dust and flammable dust
- Powerful electric or magnetic fields

### 4.2 Unpacking and transporting device



#### CAUTION

##### Risk of injury due to heavy load

You can injure yourself by carrying the instrument alone.

- Never try to carry the instrument alone. At least two people are needed to carry the instrument.

#### Unpack the device

- 1 Grip the device under the base plate.
- 2 Lift the device up and out of the foam packing material.
- 3 Place the device on the lab bench.

#### Transport the device

- 1 Unplug the power adapter.
- 2 Disconnect the device properly from the cooling media.
- 3 Grip the device under the base plate.

### 4.3 Connecting power to the device



#### WARNING

##### Risk of electric shock

- 1 Make sure to plug the power cable supplied into a power supply outlet that is grounded. A technical fault could otherwise result in serious injury or death.
- 2 Only use the METTLER TOLEDO power supply cable and AC power adapter designed for your instrument.

- 1 The power supply connection is on the back side of the device.

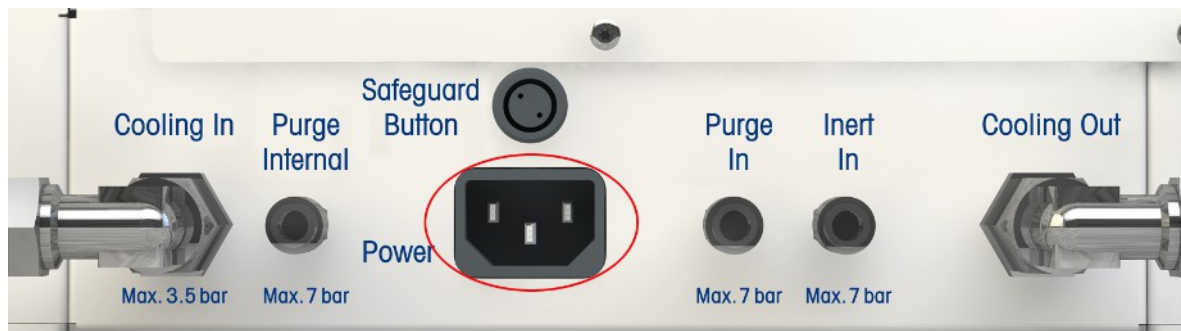

- 2 Connect the instrument to the power supply using the included country-specific cable.
- 3 Insert the plug of the power cable into a grounded power outlet that is easily accessible.

## 4.4 Connecting water cooling

The installation via the flowmeter requires three pieces of tubing, in the box you will find two. You can cut away a piece of appropriate length (it has to cover the connection from the flowmeter to the cooling in on the back side of the instrument) from one of the two delivered tubes.

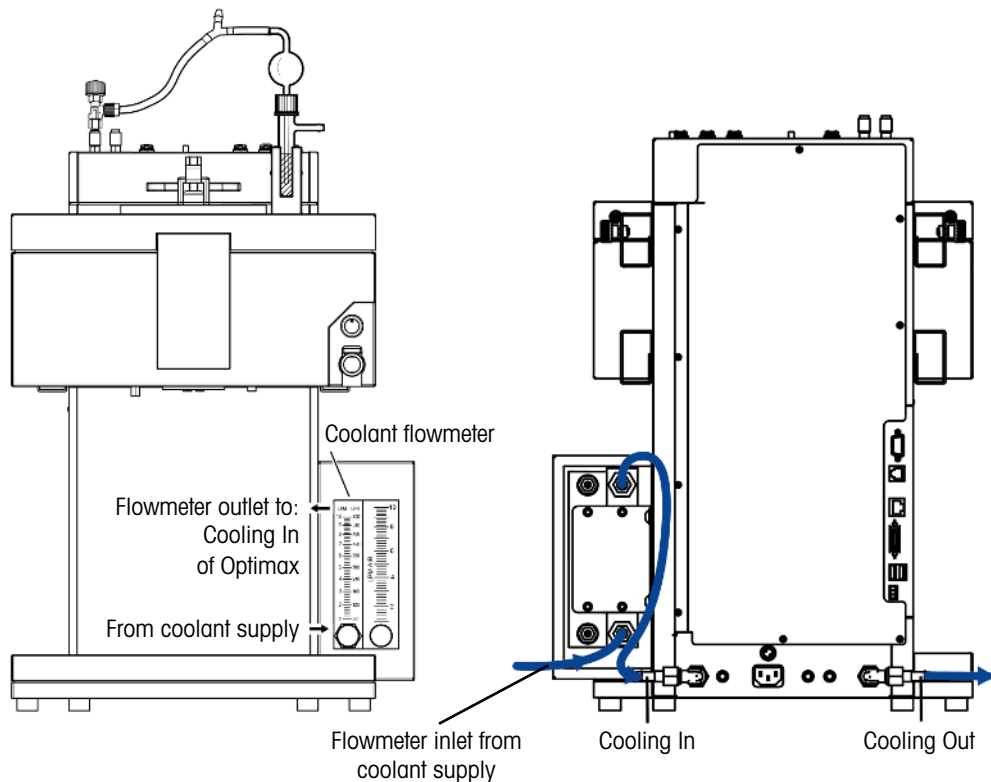

- 1 Push one piece of the PVC industrial hose (51161187) over the cooling inlet of the coolant flowmeter.
- 2 Secure it with a hose clamp.
- 3 Connect the other end to the coolant supply.
- 4 Connect the cut piece to the coolant flowmeter outlet and secure with hose clamp.
- 5 Connect the other end to the **Cooling In** of the device and secure with hose clamp.
- 6 Push the second piece of the PVC tube over the elbow coupling of the **Cooling Out** on the back side of the instrument.
- 7 Secure it with a hose clamp.
- 8 Connect the other end to the waste water system.

## 4.5 Connecting cryostat cooling



### NOTICE

#### Damage of Flowmeter

The flowmeter is not resistant to any liquids other than water! Do not use it with other coolants.



### NOTICE

#### Risk of device malfunctioning

When using silicone oil as coolant adding the antistatic additive is required. It is recommended to renew the antistatic additive after a year.

- Ensure sufficient purging of the cryostat with dry nitrogen (check also instructions on purging of cryostat manufacturer).

Do not use the flowmeter with the cryostat in order to have full capacity.

The instrument needs a constant flow of the cooling medium.

- 1 Screw the insulated connection tube over the **Cooling In** on the back of the instrument.
- 2 Use a wrench to tighten the connection to the instrument.
- 3 Screw the second insulated connection tube over the **Cooling Out** on the back of the instrument.
- 4 Use a wrench to tighten the connection to the instrument.

## 4.6 Connecting instrument purge gas

To prevent corrosion by condensed atmospheric moisture in the instrument, the instrument must be purged with a dry gas, e.g. dry air, dry nitrogen or dry argon.

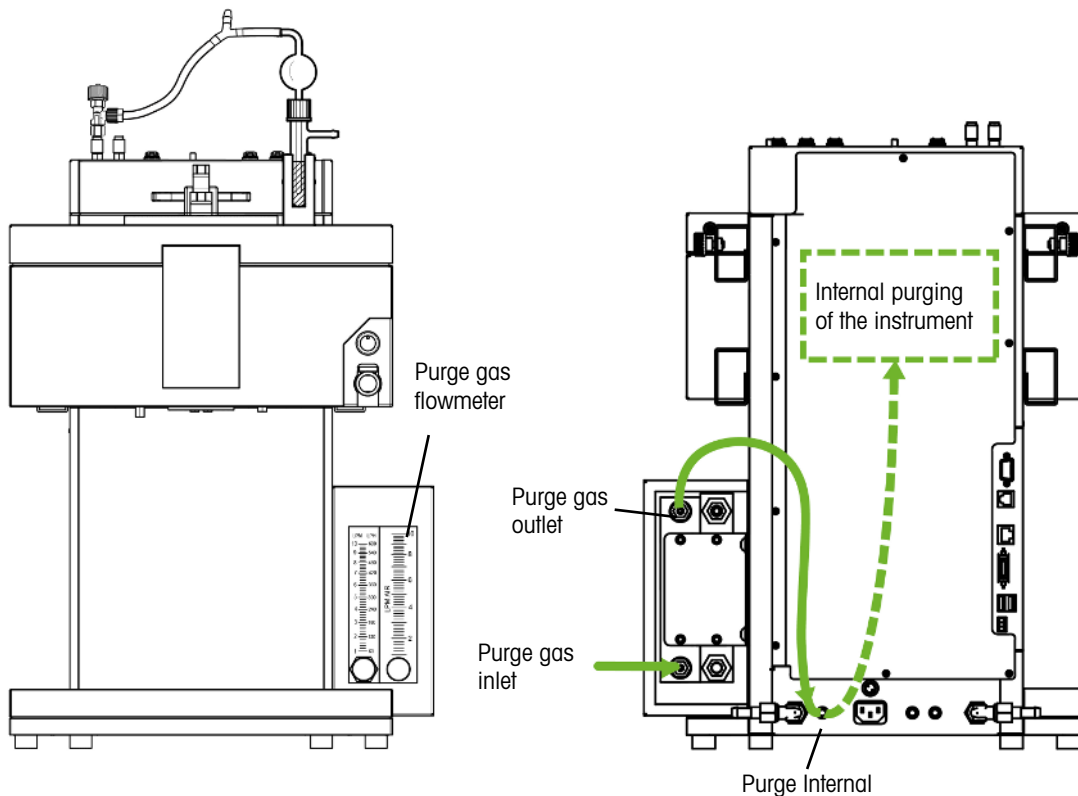

- 1 Push one piece of PVC industrial hose for purge gas (51 192239,  $\varnothing$  4/10 mm ) on the purge gas Inlet of the purge gas flowmeter.
- 2 Secure it with a hose clamp.
- 3 Connect the other end to the purge gas supply.
- 4 Push a second piece of PVC industrial hose for purge gas over the purge gas outlet of the flowmeter.
- 5 Secure it with a hose clamp.
- 6 Push the other end of the second piece over the **Purge Internal** quick connect coupling connection on the back side of the device.
- 7 Secure it with a hose clamp.



## 4.7 Purging the reactor with inert gas

To perform reactions under nitrogen (or any other inert gas) you have to install the purge tubing according to the following instructions:

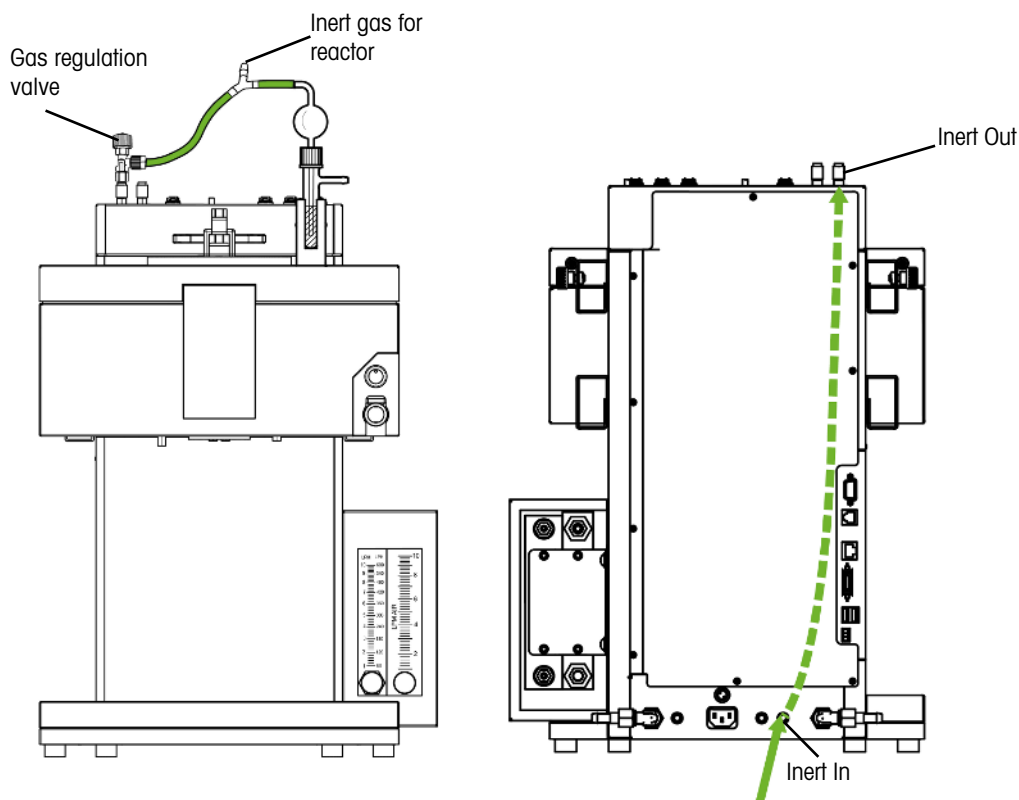

- 1 Install a quick connect coupling (51190324,  $\varnothing$  4/6 mm, red) with the PVC tube (51161186) on the **Inert In** connector on the back side of the instrument and secure it with a hose clamp.
- 2 Connect the other end of the PVC tube to the gas supply.
- 3 Install a quick connect coupling on the **Inert Out** connector on top of the instrument and push a piece of the PVC tube over the quick connect coupling.
- 4 Integrate a bubble counter with a gas regulation valve (51161802, optional available as set) and the Y-piece (51191373) into the tubing as shown in the drawing. Proceed, depending on the type of the used reactor. (The use of the Y-piece guarantees an uncritical pressure for the reactor while the gas flow can be monitored with the bubble counter).
- 5 Always leave a small opening in the reactor to allow a flow of the purge gas.

## 4.8 Connecting touchscreen to OptiMax



### NOTICE

#### Touchscreen connection / disconnection

The instrument may be seriously damaged if the touchscreen is connected or disconnected when the instrument is switched on.

- Do only connect or disconnect the touchscreen when the instrument is switched off.

- 1 The touchscreen connection is on the back side of the instrument (see picture).
- 2 Connect the touchscreen cable to the socket.
- 3 Position the touchscreen so that it is always readable.



#### 4.9 Connecting stirrer purge gas

- 1 Remove the nut on the stirrer with a hexagonal wrench (4 mm).
- 2 Remove the Swagelok fitting from metal connector.
- 3 Screw the metal connector onto the purge connector on the stirrer.
- 4 Do not tighten it completely it should stick out at least 2,5 cm from the stirrer.
- 5 Cut the tubing to an appropriate length.
- 6 Connect the quick connectors on either side of the tubing.
- 7 Connect the quick connectors to the metal connector mounted on the stirrer.
- 8 Connect the tubing to the **Purge In** on the back side of the instrument.

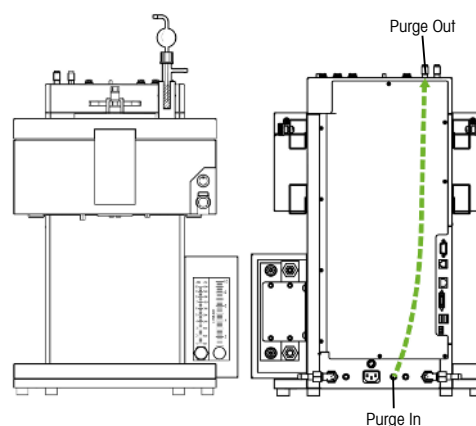
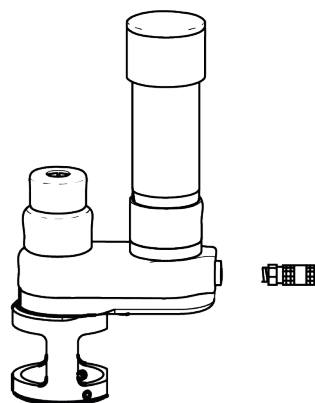

## 4.10 Connecting safeguard button to OptiMax

- Connect the safeguard button to the **Safeguard button** connector on the rear side of the instrument.



## 4.11 Assembling the Stirrer

Step 1 and 2 are not needed when the device is installed for the first time as the adapter part comes already assembled.

The assembly of the stirrer adapter (30451755) into the stirrer housing can be a bit tight in the beginning and will improve over time.

- 1 Install the PTFE cord (6) in the adapter (7).
- 2 Reinstall the pressure screw (5) and lightly tighten.
- 3 Screw the pitched-blade element (10) onto the stirrer shaft (9).
- 4 Push the stirrer shaft (9) from below through the central opening of the reactor cover.
- 5 Push the adapter loosening nut (8) over the stirrer shaft (9) and screw to the adapter (7).
- 6 Insert the adapter (7) into the central opening of the cover.

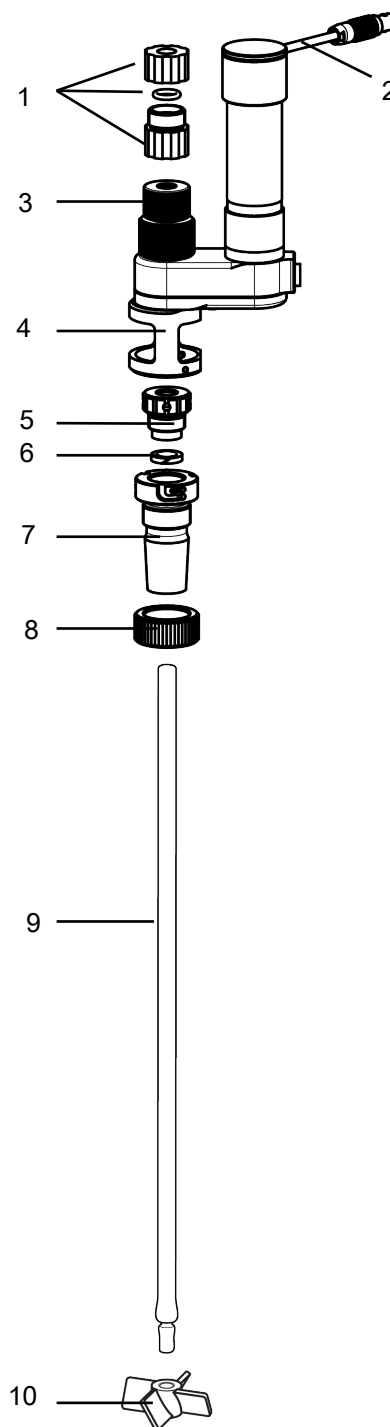

- 7 Push the stirrer shaft (9) through the hole in the stirrer assembly.
- 8 Tighten the pressure screw (5). Increasing the tightness will minimize solvent loss (or retention of vacuum).
- 9 Align the slits in the adapter (7) with the pins of the lower housing (4).
- 10 Turn the stirrer adapter (7) until you hear a click and the adapter is locked in the lower aluminum housing (4).



- 11 If necessary adapt the height of the stirrer shaft and the pitched-blade element with the reactor for an applicable immersion depth.
- 12 Fix the stirrer shaft by tightening the chuck (3) and secure it with the locking device (1) on top of the chuck (3). (The locking device prevents the stirrer shaft from falling into the reactor in case the chuck is loosened carelessly or by mistake).
- 13 Connect the stirrer cable (2) to the connector on top of the instrument housing.

To change the immersion depth of the stirrer shaft:

- 1 Release the chuck (3) while holding the stirrer shaft.
- 2 Release the locking device (1) and adapt the immersion depth.
- 3 Tighten the chuck (3) and secure it with the locking device (1).

## 4.12 Installing a Tr sensor

**Note** The Tr sensor must be immersed in the reaction solution to a depth of at least 1.5 cm to give correct measurement values.

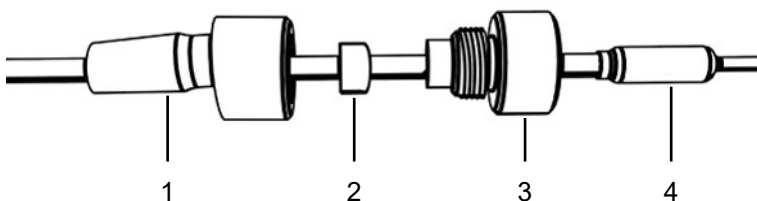

- 1 Unscrew the pressing screw (3) from the adapter and push it over the sensor (1).
- 2 Push the sealing ring (2) over the Tr sensor with the round side pointing to the screw (3).
- 3 Push the lower part of the adapter (1) over the Tr sensor.
- 4 Screw the adapter (1 & 3) lightly together.
- 5 Install the Tr sensor (4) on the reactor cover (in an appropriate port).
- 6 Connect the Tr sensor to the Tr connection on the instrument.
- 7 Check that the Tr sensor does not touch the stirrer blade or other inserts.

## 4.13 Installing a baffle

The baffle is inserted in one of the ST 19 openings of the reactor. Using the eccentric PTFE adapter (51104154) and due to the fact that the baffle itself is angular, fit the baffle in a way that it does not collide with the stirrer, the Tr sensor or any other insert of the reactor.



Baffle available on:

- 500 mL (51162638)
- 1000 mL (51162637)

## 4.14 Installing a 1000 mL two-piece reactor

Before you place the reactor in the thermostat, we recommend that you install the Tr sensor and other inserts in order to check their distance from the stirrer or the bottom of the reactor. We also recommend that you add the reagents and solvent for the starting volume and possibly check the fill level of the first fill.

- 1 Push the glass stirrer or the stirrer shaft with anchor or pitched-blade element through the central opening of the reactor cover before you place the cover onto the reactor.
- 2 Connect the stirrer shaft to the stirrer motor.
- 3 Fix the reactor holder (51162782) to one of the lab bars and place the reactor in the reactor holder.



- 4 Place the O-Ring on the cover rim and place the cover on the reactor.
- 5 Place the clamp chain carefully around the cover and the reactor flanges.
- 6 Screw the hook in or out so that the buckle can be easily closed (with one finger).

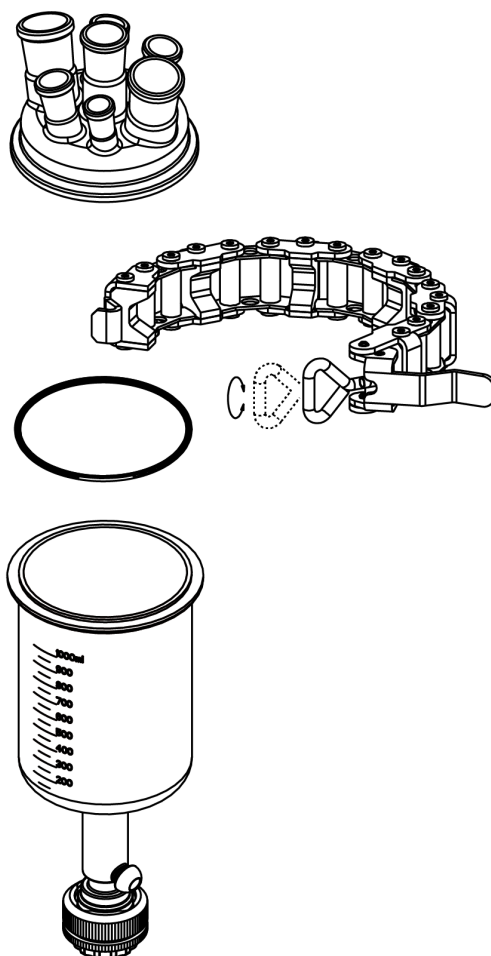

- 7 Remove the assembled reactor from the reactor holder and insert it into the thermostat.
- 8 Attach the drain union (51162685) to the bottom drain valve and fasten it with the pinch clamp.

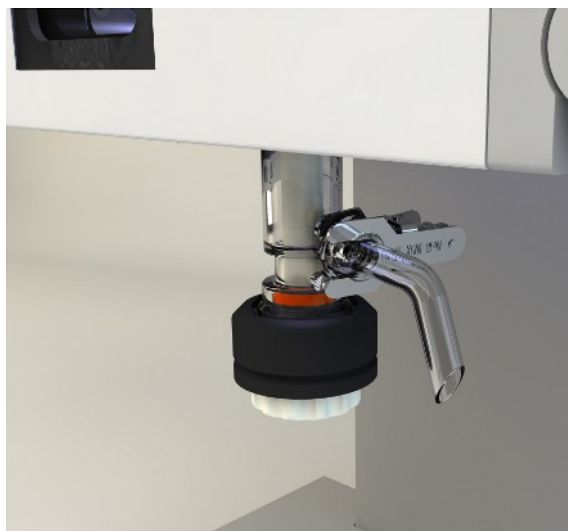

#### 4.14.1 Openings of the 1000 / 500 mL two-piece reactor cover

	Center ST24/29	Stirrer
	ST19/26 (3x)	<ul style="list-style-type: none"> <li>• pH electrode</li> <li>• Baffle</li> <li>• EasySampler</li> <li>• FBRM S/G400 long</li> </ul>
	ST 14/23 (1x)	Tr sensor or EasySampler
	ST 29/32 (2x)	

#### 4.15 Installing a 1000 mL one-piece reactor

- 1 Place the reactor in the reactor stand (51162760).
- 2 Install the stirrer with a half-moon blade in the central opening.
- 3 Install the Tr sensor.
- 4 Check that the stirrer does not touch inserts.
- 5 Add the liquids for the first fill.
- 6 Check that Tr sensor is immersed.

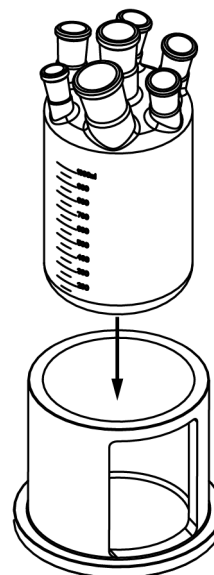

- 7 Insert the plug (51162860 with sealing 51192209) from below into the lower opening of the thermostat. This will eliminate any disturbing stack-effect from the thermostat.
- 8 Place the reactor in the reactor opening of the thermostat.
- 9 Connect stirrer and Tr sensor to the device.

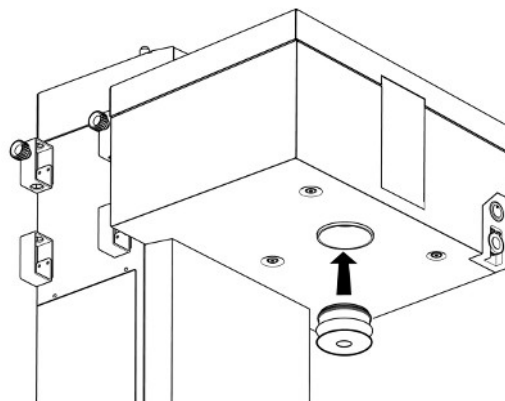

#### 4.15.1 Openings of the 1000 mL one-piece reactor cover

	Central ST24/29	Stirrer
	ST29/32 (1x)	
	ST14/23 (1x)	Tr sensor and EasySampler
	ST19/26 (4x)	<ul style="list-style-type: none"> <li>• pH electrode</li> <li>• Baffle</li> <li>• EasySampler</li> </ul>

#### 4.16 Using the rotation lock

Only applicable for two-piece reactors.

##### Using the rotation lock to fix reactor

Always lock the reactor using the rotation lock this prevents the reactor from rotating concurrently while you open or close the bottom drain valve.

- 1 Insert the reactor into the thermostat.
- 2 Push the blue rotation lock towards the reactor.
- 3 Make sure the lower pin fits into the chain and holds it in place.

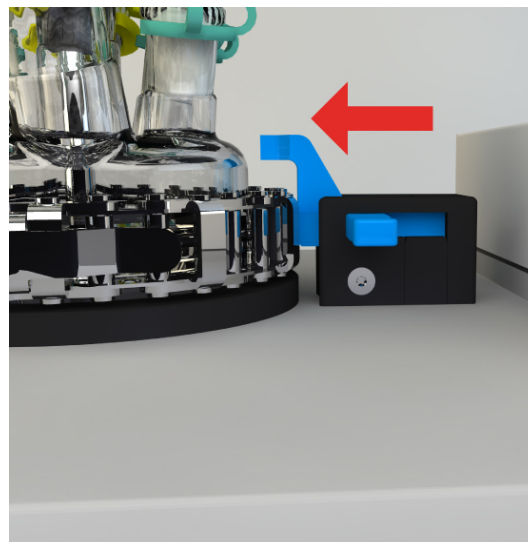



### Using the rotation lock to uplift the reactor

- Uplift the reactor and lock it with the upper pin of the rotation lock.
- ➔ You can observe the bottom of the reactor through the reactor window.

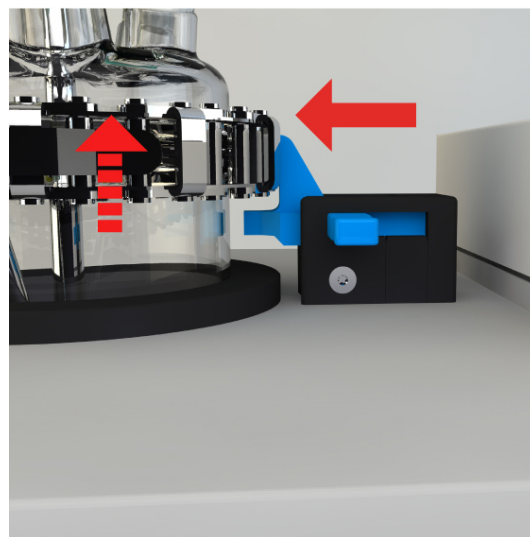

## 4.17 Installing smaller two-piece reactors

For OptiMax also 500 mL and 250 mL reactors are available. The installation procedure is very similar to the 1000 mL reactor.

The only difference are the order numbers for reactor size specific items and the installation of a receptacle into the thermostat

- 1 Install and prepare the reactor as described in the chapter [Installing a 1000 mL two-piece reactor Page 28].
- 2 Before placing the assembled reactor into the thermostat, install the receptacle.
- 3 Insert the receptacle into the thermostat with the window heading forward. Make sure the locking pin on the side snaps into place.
- 4 Remove the assembled reactor from the reactor holder and insert it into the receptacle in the thermostat.
- 5 Attach the drain union (51 162685) to the bottom drain valve and fasten it with the pinch clamp.

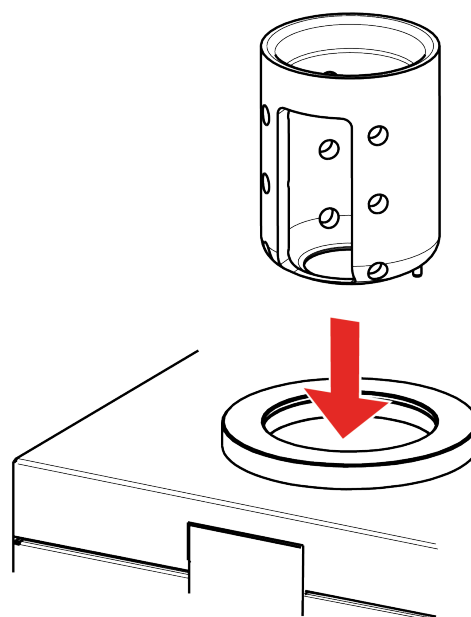

### 4.17.1 Openings of the 250 mL two-piece reactor cover

	Central ST 24	Stirrer
	ST 14/23 (2x)	Tr Sensor and EasySampler
	ST 19/26 (4x)	<ul style="list-style-type: none"> <li>• pH electrode</li> <li>• EasySampler</li> </ul>

## 4.18 Installing smaller one-piece reactors

For OptiMax also 500 mL and 250 mL reactors are available. The installation procedure is very similar to the 1000 mL reactor.

The only difference are the order numbers for reactor size specific items and the installation of a receptacle into the thermostat.

Instead of the reactor holder, the reactor stand (51162759 for 500 mL reactor and 51162758 for 250 mL reactor) is used to store and prepare the reactor.

- 1 Before placing the assembled reactor into the thermostat, install the receptacle.
- 2 Insert the receptacle into the thermostat with the window heading forward. Make sure the locking pin on the side snaps into place.
- 3 Insert the plug (51162860 with sealing 51192209) from below into the lower opening of the thermostat. (This will eliminate any disturbing stack-effect from the thermostat).
- 4 Remove the assembled reactor from the reactor stand and insert it into the receptacle in the thermostat.

### 4.18.1 Openings of the 500 mL one-piece reactor

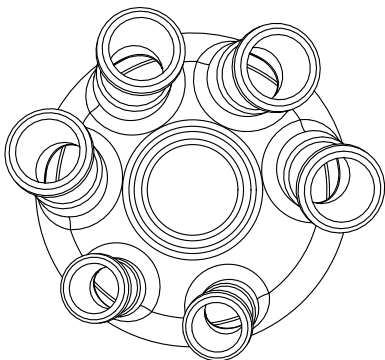
	Central ST 24/23	Stirrer
	ST 14/29 (2x)	Tr Sensor and EasySampler
	ST 19/26 (4x)	<ul style="list-style-type: none"> <li>• pH electrode</li> <li>• EasySampler</li> </ul>

### 4.18.2 Openings of the 250 mL one-piece reactor

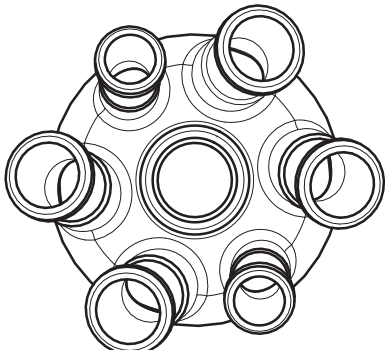
	Central ST 24/29	Stirrer
	ST 14/23 (2x)	Tr Sensor and EasySampler
	ST 19/26 (4x)	<ul style="list-style-type: none"> <li>• pH electrode</li> <li>• EasySampler</li> </ul>

## 4.19 Turn on Device

- Power is connected.
- Cooling is connected and running.
- Purging of instrument is connected and running.
- Touchscreen is connected
- Press the ON/OFF button on the front side of the instrument.
  - ➔ You should hear an audible click and the LED illuminates.
  - ➔ The touchscreen shows a splash screen during start up phase.
- ➔ You can use the device as soon as the mainscreen appears.

## 5 Operation

### 5.1 Change safety settings

- 1 Tap the Reactor button.
- 2 Tap on the **Safety** field.
- 3 Change the necessary parameters according to your experiment and setup.

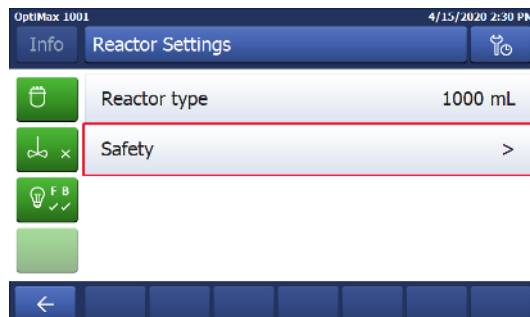

#### 5.1.1 Change safety temperature (T safe)

- 1 Tap on **T safe**.
- 2 Enter a value for **T safe** that is valid for your experiment.
- 3 Tap **OK**.



Parameter	Description	Values
Tsafe	Defines the temperature to which the reaction will be cooled in case of an emergency program E.	According to your chemistry

#### 5.1.2 Change reaction temperature limits (Tr)

- 1 Tap on **Tr max** or / and **Tr min**.
- 2 Enter a value for **Tr max** and **Tr min** that is valid for your experiment.
- 3 Tap **OK**.



Parameter	Description	Values
Trmax	Defines the maximum temperature Tr value can reach during an experiment and the user can enter in the Reactor view. If the temperature rises above that value the Emergency program E is triggered	Tsafe + 3K...183 °C
Trmin	Defines the minimum temperature the Tr value can reach during an experiment and the user can enter in the Reactor view. If the temperature falls below that value the Emergency program E is triggered.	-43 °C...Tsafe - 3K

### 5.1.3 Change range of jacket temperature (Tj)

- 1 Tap on **Tj min** or / and **Tj max**.
- 2 Enter a value for **Tj min** and **Tj max** that is valid for your experiment.
- 3 Tap **OK**.

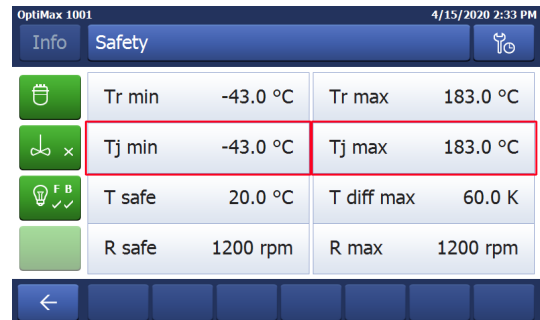

Parameter	Description	Values
Tj max	Defines the maximum temperature a Tj value can reach during an experiment and the user can enter in the reactor view. If the temperature rises above that value the emergency program E is triggered.	Tsafe + 3K...183 °C
Tj min	Defines the minimum temperature the Tj value can reach during an experiment and the user can enter in the reactor view. If the temperature falls below that value the emergency program E is triggered.	-43 °C...Tsafe - 3K

### 5.1.4 Change T diff max

- 1 Tap on **T diff max**.
- 2 Enter a value for **T diff max** that is valid for your experiment.
- 3 Tap **OK**.



Parameter	Description	Values
T diff max	Defines the temperature difference that is allowed between Tj and Tr.	Dependent on: <ul style="list-style-type: none"> <li>Reactor type</li> </ul>

### 5.1.5 Change Rsafe

- 1 Tap on **Rsafe**.
- 2 Enter a value for **Rsafe** that is valid for your experiment.
- 3 Tap **OK**.

Info		Safety	
Tr min	-43.0 °C	Tr max	183.0 °C
Tj min	-43.0 °C	Tj max	183.0 °C
T safe	20.0 °C	T diff max	60.0 K
<b>R safe</b>	<b>1200 rpm</b>	R max	1200 rpm

Parameter	Description	Values
Rsafe	Determines the stirrer speed in case of an emergency.	<ul style="list-style-type: none"> <li>Hold rpm</li> <li>User-defined rpm: 0 -1200 rpm</li> </ul>

### 5.1.6 Change Rmax

- 1 Tap on **Rmax**.
- 2 Enter a value for **Rmax** that is valid for your experiments.
- 3 Tap **OK**.

Info		Safety	
Tr min	-43.0 °C	Tr max	183.0 °C
Tj min	-43.0 °C	Tj max	183.0 °C
T safe	20.0 °C	T diff max	60.0 K
R safe	1200 rpm	<b>R max</b>	<b>1200 rpm</b>

## 5.2 Experiment

### 5.2.1 Select Reactor type

- 1 Tap the icon Reactor 1000 mL.
- 2 Tap the **Reactor type** field.

Info		New experiment	
Tr	25.3 °C	Dose / Charge	
Reactor temperature			
Tr - Tj	0.4 K	Sample	
Distill / Reflux		EasySampler ready	
Tj	24.9 °C	pH	
Jacket temperature		7.00	
R	0 rpm		
Stirring			

- 3 Select the reactor type that is installed.

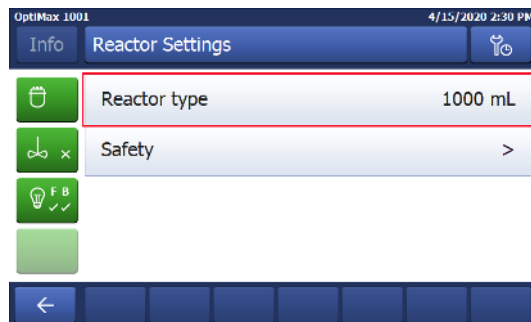

- ➔ Make sure the safety settings for the reactor are still within the range.

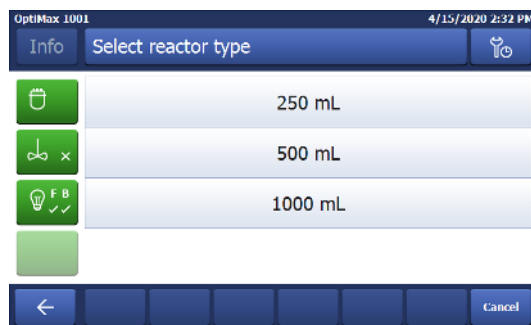

## 5.2.2 Start an experiment

Data that is stored outside of an experiment is lost when turning off the device. Data within the experiment is stored on the device for 10 days.

- 1 Tap the experiment button on the main screen.
  - 2 Enter an **experiment name**.
  - 3 Tap **Start** to start the experiment.
- ➔ All tasks that are executed will be saved under the experiment and available for export.

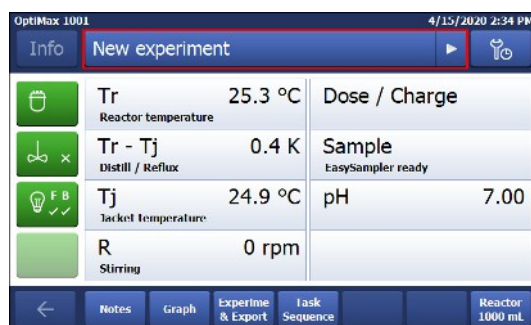

## 5.2.3 Stirring

### 5.2.3.1 Change stirrer speed

**Note** The value cannot be higher than the safety limit value.

- A stirrer is connected.
- 1 Tap on the **R** field.

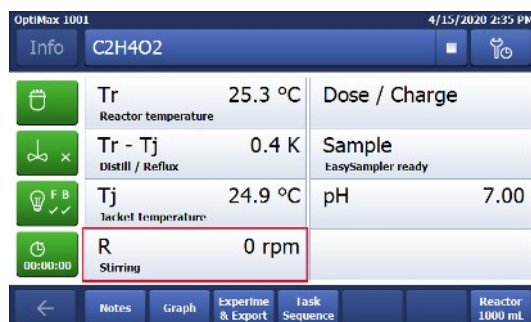

- 2 Enter the desired value.
  - 3 Tap **Start**.
- ➔ The stirrer will immediately start stirring.



### 5.2.3.2 Create a stirrer speed ramp

- A stirrer is connected.
- 1 Tap the **R** field.
  - 2 Tap **Advanced**.

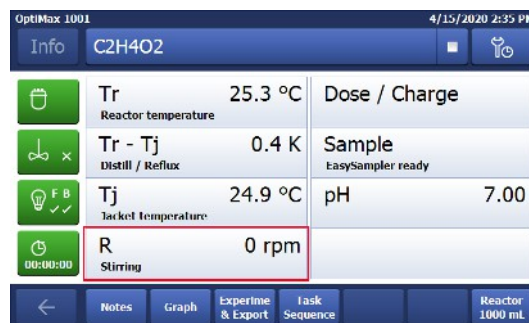

- 3 Enter a stirrer end speed (R end).
  - 4 Enter the duration of the ramp.
  - 5 Tap **Start**.
- ➔ The stirrer will immediately start stirring.



### 5.2.4 Add a time marker

The time marker is only active if an experiment is running.  
Time markers can be added on the touchscreen with two possibilities:

- Action button in green on the left side of main screen.
- In the Trend graph viewer by tapping on the trend graph.

Parameters	Description
Time marker	The time marker allows users to define a specific moment within an experiment which he wants to refer to a time "zero" e.g. the addition of a catalyst or the nucleation of the first crystal. Once a first time marker is set, the user has an additional option to shift the timeline, setting time zero on the time marker. A user may choose to set multiple time markers, allowing to shift time zero to different spots throughout the experiment.



### Add time marker on main screen

- 1 Tap on the time marker symbol on the main screen.

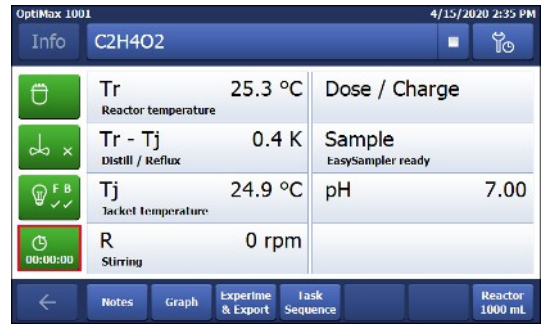

- 2 Enter a name for the time marker.
- 3 Tap **OK** to add the time marker to the experiment.



### Add time marker in the trend graph

- 1 Tap on the **Graph** button.
- 2 Tap in the graph area where you would like to set a time marker.



- 3 Choose time marker from the options.

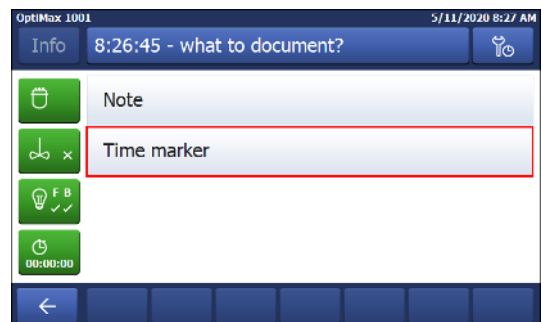

- 4 Enter a name for the time marker.
- 5 Tap **OK** to add the time marker to the experiment.





## 5.2.5 Manual sampling

- 1 Tap on **Sample** on the mainscreen.

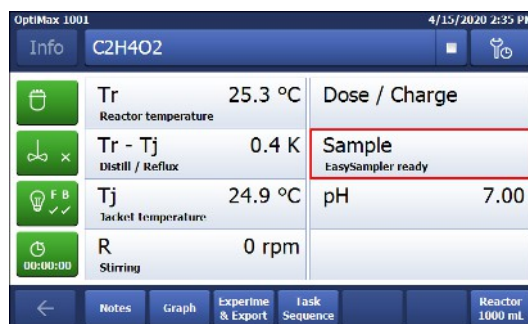

- 2 Change the name of the sample or use the default name.
- 3 Tap **OK**.



### Check manual samples

- 1 Tap **Sample** on the main screen.
  - 2 Tap **List** at the bottom left of the screen.
- ➔ All samples are shown with name and time stamp.

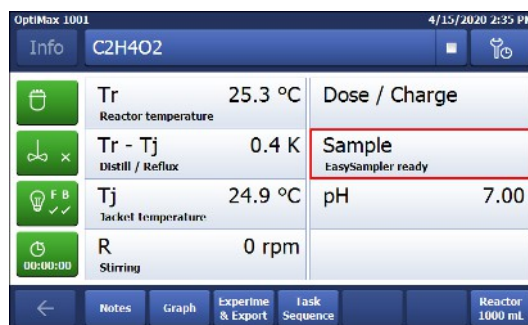

## 5.2.6 Manual add

- 1 Tap **Dose / Charge**.

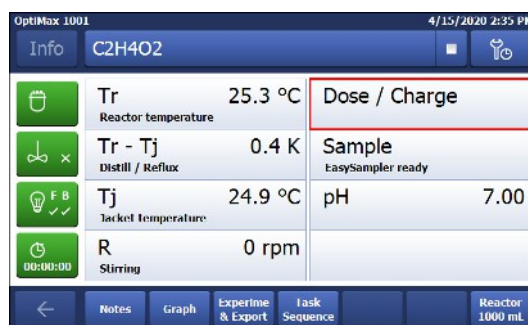

- 2 Select **Manual Add**.

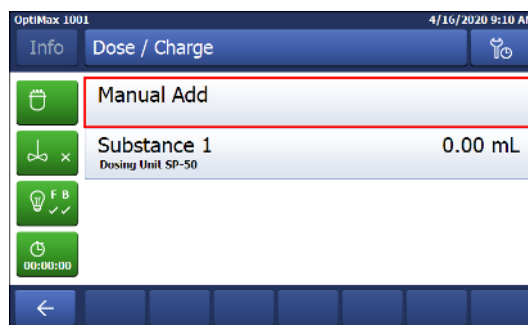

- 3 Enter the correct parameters. Per default the manual add is set to dose everything at once. If you want to change that enter a duration or rate.

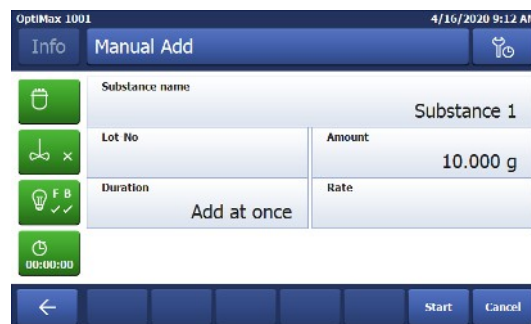

## 5.2.7 End an experiment

- 1 Tap on the Stop button on the mainscreen.
- 2 Select your preferred option for experiment end conditions.
- 3 Tap **OK**.
  - ➔ Your experiment is stored on the device and can be exported.

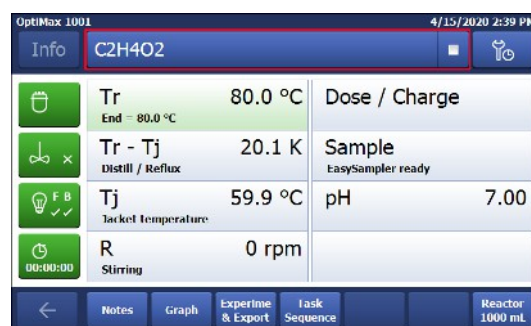

## 5.2.8 Export data from a defined time frame

- An USB stick is inserted in the USB port.
- 1 Tap on **Experiment & Export**.
  - 2 Choose **Export time period**.
  - 3 You can change the time period by tapping on Time period start / Time period end.
  - 4 Tap on **Start Export**.
    - ➔ The touchscreen will show a message when export is finished and successful.

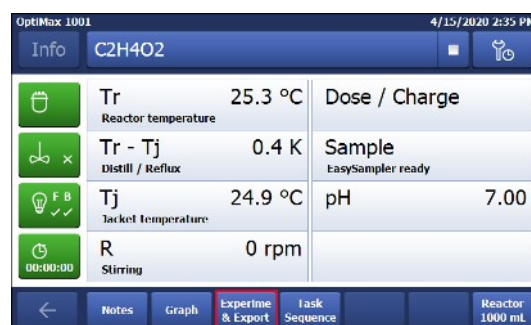

## 5.2.9 Export single experiments

- An USB stick is inserted in the USB port.
- 1 Tap on **Experiment & Export**.

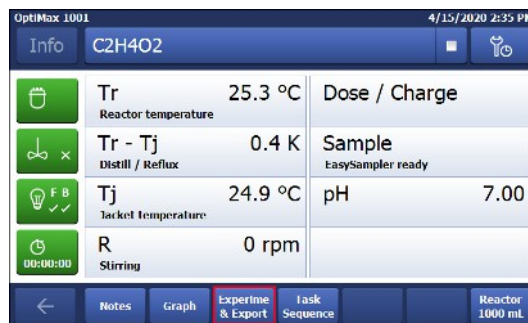

- 2 Choose **Experiment List**.
  - 3 From the **Experiment List** choose the experiment you want to export.
  - 4 Tap on **Start Export**.
- ➔ The touchscreen will show a message when export is finished and successful.

Interval time can be changed in order to minimize data volume and time for export.

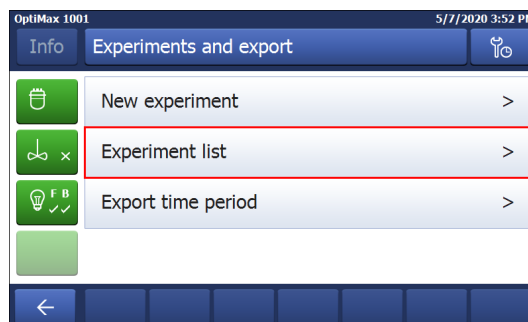

## 5.3 Heating and cooling

### 5.3.1 Change Tj

**Note** The value cannot be higher than the safety limit value.

- 1 Tap the **Tj** value field on the main screen.
  - 2 Enter the end temperature for **Tj**.
  - 3 Tap **Start** to initiate the task.
- ➔ The task will start immediately.

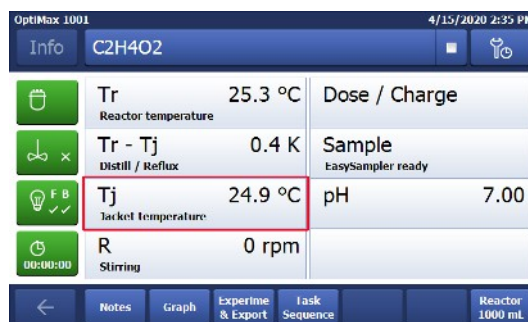

### 5.3.2 Create a Tj Ramp

- 1 Tap the **Tj** value field on the main screen.

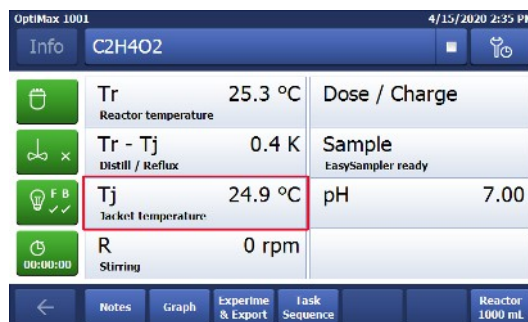

2 Tap **Advanced** to enter the ramp settings.

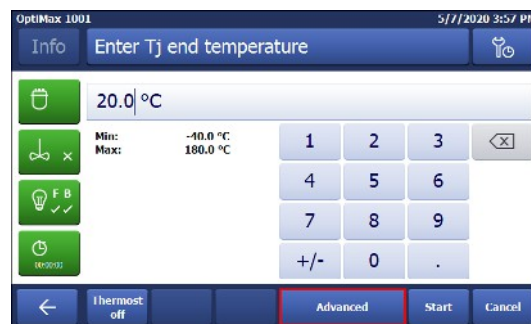

3 Enter the end temperature for **Tj**.

4 You can chose between **Duration** or **Rate**.

5 Tap **Start** to initiate the task.

➔ The Tj ramp will start immediately.

Using the task sequence, you can also have your ramp starting at a certain point in the reaction.



Parameters	Description
<b>Tj end</b>	Defines heating or cooling the reactor jacket over a certain duration or by rate.
<b>Duration</b>	Defines the end temperature at the end of the timespan you have entered.
<b>Rate</b>	Defines the end temperature is reached through the centigrade per minute you have defined.
<b>Linear ramp</b>	The exponent defines the shape of the curve, you can get an estimate of how the curve will look from the graphic.

### 5.3.3 Change Tr

**Note** The value cannot be higher than the safety limit value.

- A Tr sensor is connected to the thermostat.

1 Tap the **Tr** value field on the main screen.

2 Enter the end temperature for Tr.

3 Tap **Start** to initiate the task.

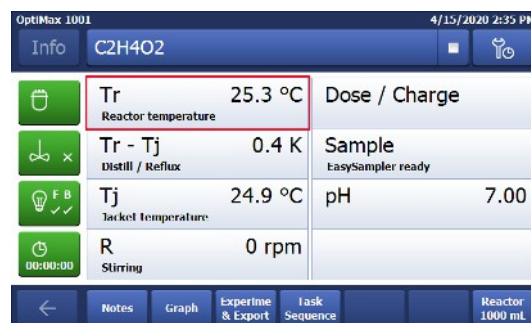

### 5.3.4 Create a Tr Ramp

- A Tr sensor is available.

1 Tap the **Tr** value field on the main screen.

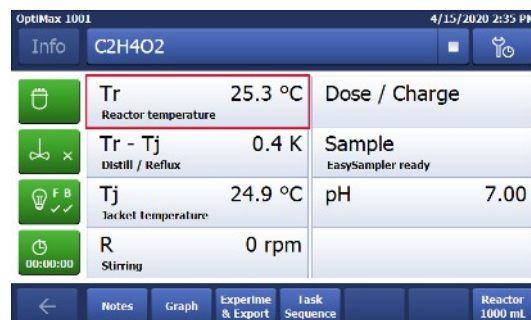

2 Tap **Advanced** to enter the ramp settings.

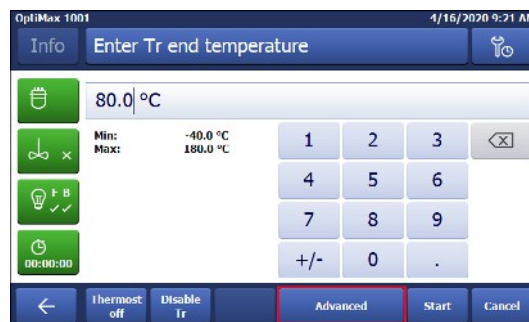

3 Enter the end temperature for Tr.

4 You can chose between **Duration** or **Rate**.

5 Tap **Start** to initiate the task.

➔ The Tr ramp will start immediately.



Parameters	Description
<b>Tr end</b>	Defines heating or cooling the reactor jacket over a certain duration or by rate.
<b>Duration</b>	Defines the end temperature at the end of the timespan you have entered.
<b>Rate</b>	Defines the end temperature is reached through the centigrade per minute you have defined.
<b>Linear ramp</b>	The exponent defines the shape of the curve, you can get an estimate of how the curve will look from the graphic.

### 5.3.5 Disable Tr

The Tr sensor can be disabled. Disabling the Tr sensor will also disable the Reflux / Distillation mode.

1 Tap the **Tr** value field on the main screen.

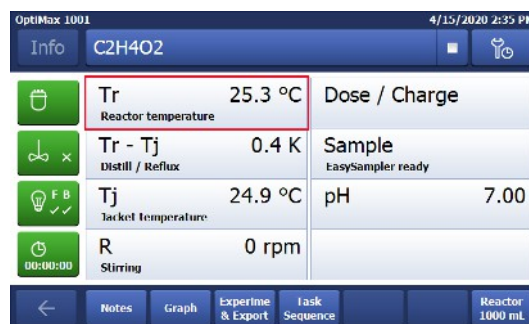

2 Tap **Disable Tr**.

➔ The Tr sensor is now disabled and will no longer show values.





### 5.3.6 Create a distill / reflux operation

- Tr sensor has to be connected and enabled.
- 1 Tap the Tr-Tj field.

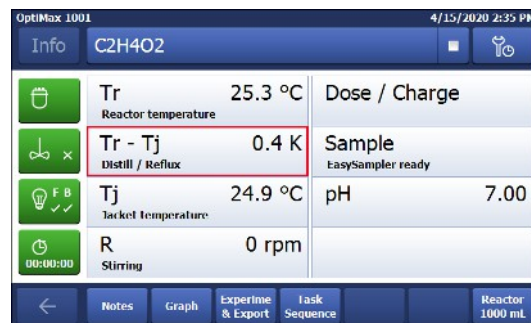

- 2 Enter a Tj end temperature.
- 3 Tap **OK**.
- 4 Tap **Distill / Reflux** and enter a Tj-Tr value appropriate for your reaction. For more details [Distill / Reflux mode (Tj-Tr) Page 15]
- 5 Tap **OK**.
- 6 When all parameters are entered correctly tap **Start**.
  - ➔ The action will start immediately.



## 5.4 Trend graph

### 5.4.1 Enter trend graph screen

- Tap on the **Graph** button.

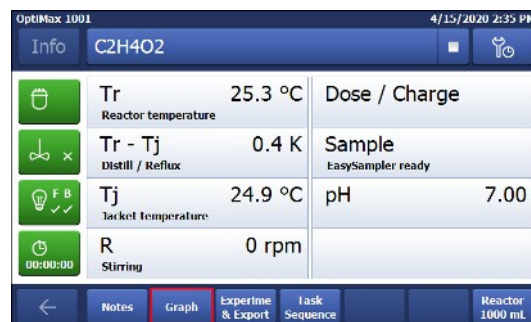

- ➔ The trend graph viewer is displayed.



### 5.4.2 Select trend graph

You can display four trend graphs in the trend graph viewer.

- 1 Tap on one of the parameters in the upper part of the trend graph viewer.

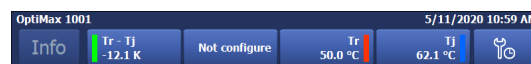

- 2 Tap on **Shown trend** to change the displayed trend.
- 3 Select the trend you want to display.
- 4 Tap **Apply** to display the trend graph.

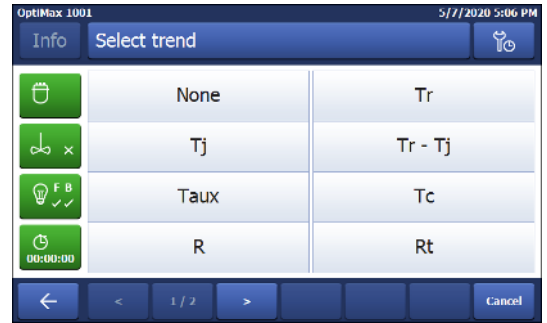

### 5.4.3 Navigation in trend graphs

In the graph you can navigate in two ways:

- Going left or right on the time axis
- Zooming

#### Navigation on time axis

- Use the arrows to navigate on the time axis.



#### Zooming

- 1 Touch the screen with your finger and move it diagonally on the area you want to zoom on the graph.
- 2 To end the zoom tap **No zoom** to return to the normal view.

### 5.4.4 Add notes in trend graph view

- 1 Enter the trend graph view.
  - 2 Tap on **Note**.
  - 3 Enter your note.
  - 4 Tap **OK**.
- ➔ Notes are shown on the trend graph as red triangles.



#### Adding a note in the trend graph screen

- 1 Tap on the trend screen where you want to have the note.
  - 2 Choose **Note**.
  - 3 Enter your note.
  - 4 Tap **OK**.
- ➔ Notes are shown on the trend graph as red triangles.

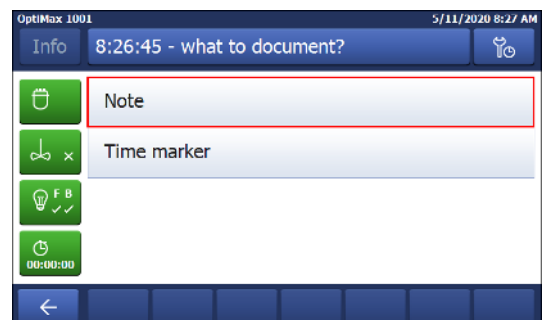

## 5.4.5 Change color of trend graphs

- 1 Tap on the trend graph that you want to change.
- 2 Tap on **Color**.
- 3 Select the new color of the trend graph.
- 4 Tap on **Apply**.

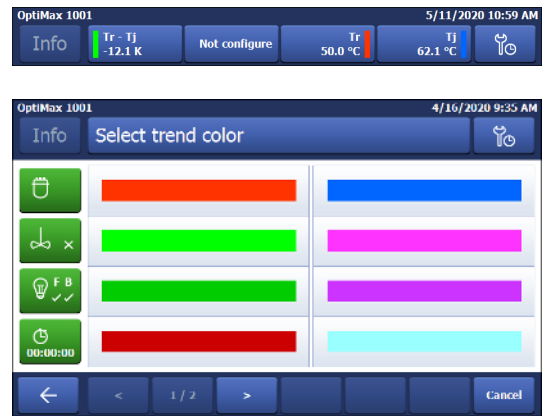

## 5.4.6 Take snapshot

The snapshot is taken from the whole trend graph area, if you want to have a specific part of the experiment as a snapshot you can use the zoom function.

- Tap on **Take Snapshot**.



## 5.4.7 Export snapshot

- An empty USB stick is inserted.

  - 1 Tap **Export Snapshot**.
  - 2 Select the Snapshot you want to export from the list.

➔ The Snapshot is stored on the USB stick.



## 5.4.8 Experiment time and time of day

You can choose between two time displays:

- Time of day
- Relative time
- You can toggle between the two time displays by tapping the button on the right bottom of the screen.





## 5.5 Task sequence

### 5.5.1 Preparing a task sequence

It is possible to preprogram a task sequence with up to 6 steps.

The following operations can be used:

- Tr (only if connected)
- Tj
- Tr - Tj
- R
- Wait
- Dosing with a DU SP-50 (only if connected)
- Dosing via an ECB (only if connected)

1 Tap on button **Task Sequence**.

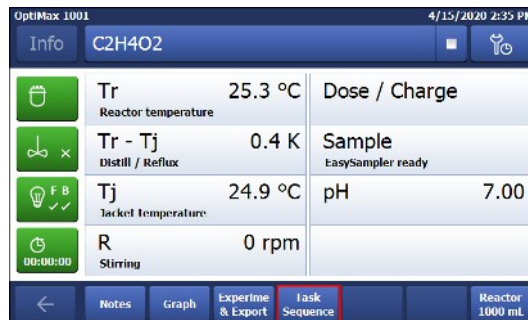

2 Tap on button **Step 1**.

3 Choose an action from the list of parameters.

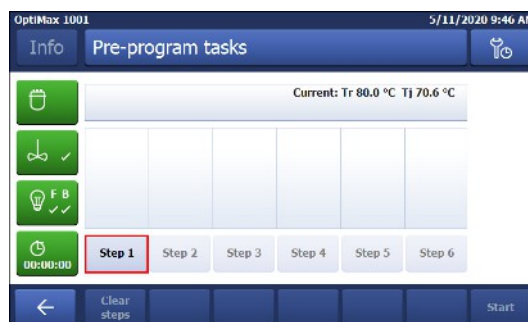

4 Enter desired values for the parameter.

5 Tap **OK**.

6 Repeat as often as needed or up to 5 times.

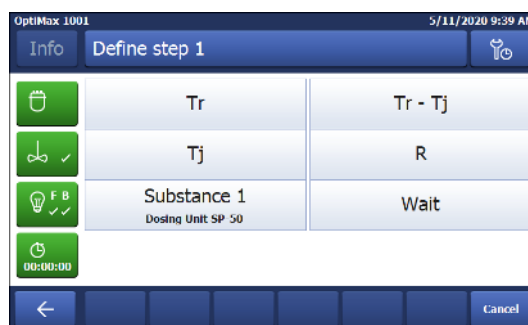

7 Tap **Start** to initialize your task sequence.

➔ The **Task Sequence** will start immediately.



## 5.5.2 Edit steps in a task sequence

You can edit a step as long as it has not run yet or is not active.

- 1 Tap on the step you want to change.
  - 2 Select the correction task from the list.
  - 3 Enter the correct parameters for your experiment.
  - 4 Tap on **OK**.
- ➔ The edited step is shown in the **Task sequence**.

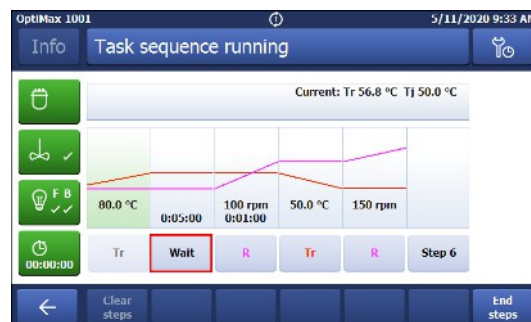

## 5.5.3 End a task sequence

- The task sequence is running.
- Tap in the task sequence window on the **End Steps** button.
- ➔ The sequence will stop immediately.
- You can reactivate the steps by pressing start or delete all steps by pressing clear steps.

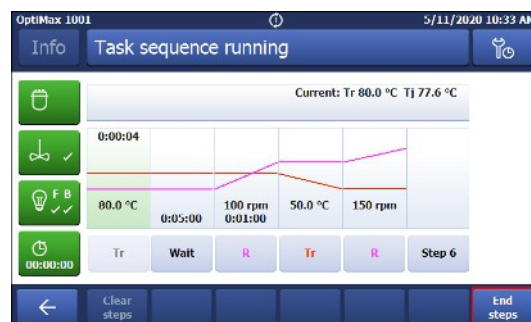

## 5.6 Settings

### 5.6.1 Change network settings

This function may be needed if you want to connect the instrument to the software.

The DHCP allows to automatically integrate a device into an existing network without manual configuration. When the system is started, it obtains the IP address and the subnet mask from the DHCP server.



If a DHCP server is not available, the IP address and the subnet must be manually entered.

**Note** Instruct the person responsible for IT to make the following settings.

For further details on how to connect the device to the network, please also check the iControl Quick Install Guide (51710672)

- 1 Tap .
- 2 Tap on **System Settings**.
- 3 Tap on **Network settings**.
- 4 Select IP-Address to enter the IP-address manually. In case DHCP is enabled, a warning screen asks you to disable it.
- 5 Enter the IP-Address and confirm it with **OK**.
- 6 Select Subnet Mask and enter the subnet mask.
- 7 Confirm your entry with **OK**.

The following icons appear in the statusbar when the device is connected to applications or a data export is in progress.

Icon	Description
	Export of experiment currently executed. This icon represents an export through USB or LAN
	iControl connection established

Icon	Description
	iC Data Center connection established

## 5.6.2 Change time settings

You can change different parameters:

- Date and time
- Time zone
- Date format
- Time format



### NOTICE

#### Changing time settings

Changing the Time zone or Date and Time can lead to loss of experiment data. A warning on the touchscreen will appear.

- Make sure you have exported your experiment data.

- 1 Tap .
- 2 Tap on **System settings**.
- 3 Tap **Time settings**.
- 4 Select the time setting you want to change.

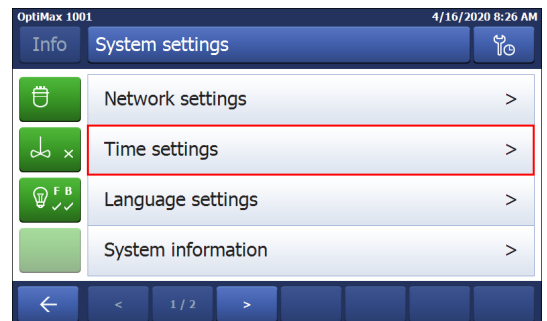

### 5.6.2.1 Change date and time



### NOTICE

#### Changing time settings

Changing the Time zone or Date and Time can lead to loss of experiment data. A warning on the touchscreen will appear.

- Make sure you have exported your experiment data.

- 1 Tap on **Date and time**.
- 2 You can change the values by tapping on the plus and minus buttons.
- 3 Tap **OK**.
- 4 Tap **Apply** if you have saved your data.



### 5.6.2.2 Change time zone

- 1 Tap on **Time zone**.

- 2 Select the time zone you are in. You can go through the pages by tapping the arrow button.
- 3 Tap **Apply**.



### 5.6.2.3 Change date format

- 1 Tap on **Date format**.
  - 2 Choose one of the formats.
  - 3 Tap **Apply**.
- ➔ The date format is changed. This change has no influence on the data storage.

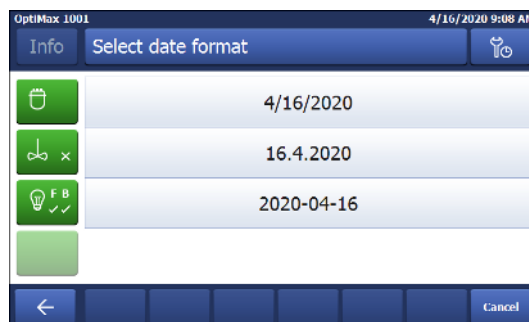

### 5.6.2.4 Change time format

- 1 Tap on **Time format** to toggle between the English version with AM/PM or the standard version with just the numbers.
- 2 If you change the Time format, the display of Date and Time will be updated accordingly.

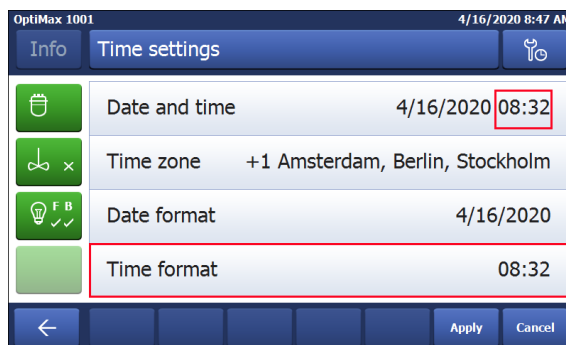
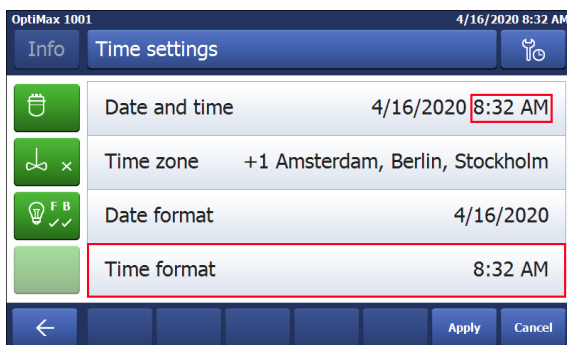

### 5.6.3 Change language

- 1 Tap .
- 2 Tap on **System settings**.
- 3 Tap **Language settings**.

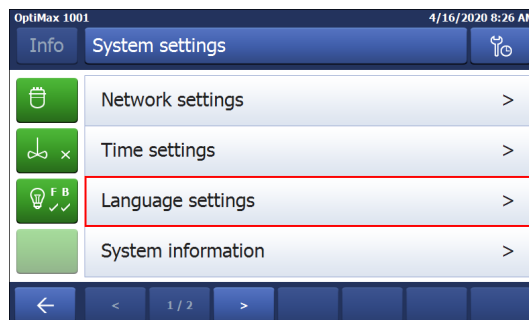

4 Tap **Language**.

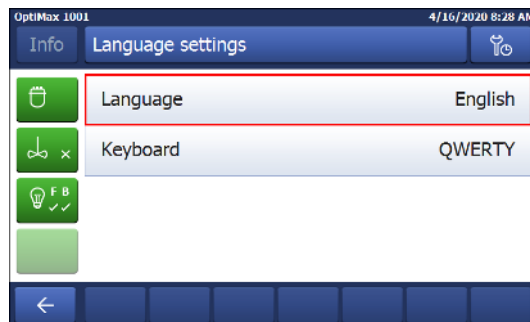

5 Select the desired language. The following languages are available:

- English
- German
- Spanish
- French
- Japanese
- Chinese



### 5.6.4 Change keyboard layout

- 1 Tap .
- 2 Tap on **System settings**.
- 3 Tap **Language settings**.
- 4 Tap on **Keyboard**.

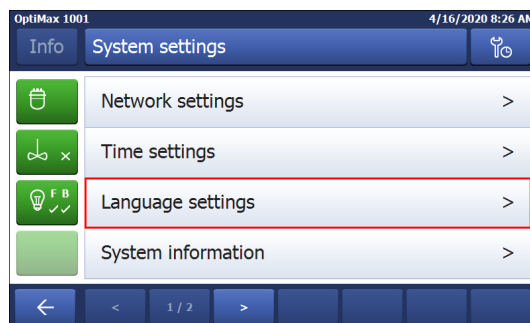

- 5 Choose one of the three layouts.  
➔ The setting is automatically applied.

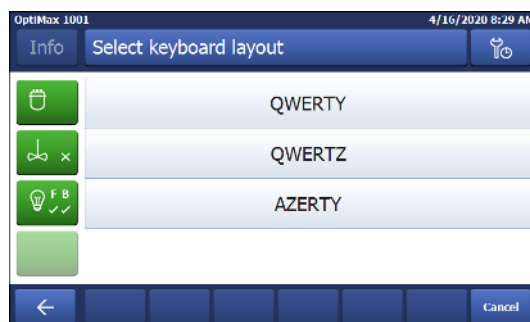

### 5.6.5 System information

- 1 Tap .
- 2 Tap on **System settings**.
- 3 Tap **System Information**.
- 4 The following information are displayed:
  - Firmware version
  - Serial number
  - Machine ID

### 5.6.5.1 Export logfiles

Exporting log files can be necessary if a problem with the device occurs. This helps our support to evaluate the problem.

- An USB stick is inserted in the device.
  - 1 Tap .
  - 2 Tap on **System settings**.
  - 3 Tap **System Information**.
  - 4 Tap the button **Export log files**.

## 6 Maintenance

Maintenance tasks have to be performed in accordance with the instructions given in this chapter. After performing any maintenance tasks, it should be ensured that the device still meets all safety requirements.

### 6.1 Update Firmware

The latest firmware versions and instructions for installation are available on the following website:  
<https://community.autochem.mt.com/?q=software>

### 6.2 Checking the Reactor

To check the reactor vessel for possible damage (scratches and cracks), it must be empty, clean, dry and open. Small hairline cracks can be detected by refraction using an additional light source (focused, not dispersed light).

### 6.3 Cleaning the Instrument



#### CAUTION

##### Hot instrument parts

Touching hot parts of the instrument can result in burnings.

- Do not clean the instrument before all parts have reached room temperature.



#### NOTICE

##### Damage to the device due to incompatible cleaning agents

Inappropriate cleaning agents could damage the housing of the device.

- 1 Use the described cleaning agent.
- 2 Should you use other cleaning agents, ensure that they are compatible with the housing material.

The housing of the instrument is not watertight (i.e. splash proof). We therefore recommend that you clean it with a damp cloth using ethanol.

If you have questions about the compatibility of cleaning agents, contact your authorized METTLER TOLEDO dealer or service representative.

### 6.4 Replacing the valve plug of the bottom drain valve

The 2-piece reactors are supplied with a bottom drain valve with a valve plug made of LUBRIFLON 904.

The valve plug needs to be replaced if:

- It becomes black and hard (high temperatures).
- It has been attacked by chemicals (swollen).

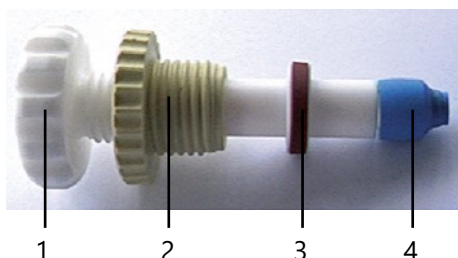

- The reactor has to be empty.

- 1 Loosen the spindle (1) of the drain valve, unscrew the pressure screw (2) and pull the valve out of the valve guide.
- 2 Using a sharp knife, make two or three vertical cuts in the valve plug (4), turn it slightly and pull it away from the glass spindle.

- 3 Warm the new plug in hot water and push it over the glass spindle. The groove in the glass spindle helps to keep the plug in place.

## 6.5 Disassembling bottom drain valve for cleaning

The bottom drain valve is delivered already assembled.

The spindle has a strong spring integrated, which compensates expansion and contraction of the reactor materials caused by variations in temperature. At the same time it ensures a proper sealing of the drain. To retain the function of this spring and to avoid breaking of the reactor glass always close the bottom drain valve hand-tight and afterwards reopen it slightly (quarter to half a turn).

In case the valve cannot be disassembled easily due to contamination from the outside, try to rinse it from the outside with a suitable solvent. Never use force while trying to disassemble the valve!

To disassemble the valve for cleaning proceed as follows:

- 1 Unscrew the spindle (6) and pull it slightly back.
- 2 Loosen the pressure screw (5) slightly and remove the spindle (6) from the valve.
- 3 Loosen the pressure screw completely and put it aside.
- 4 Remove the pressure piece (4) and the sealing ring (3).
- 5 Remove the insert ring (2) and take away the connecting nut (1).

The reassembly of the bottom drain valve can be learned from the following picture:

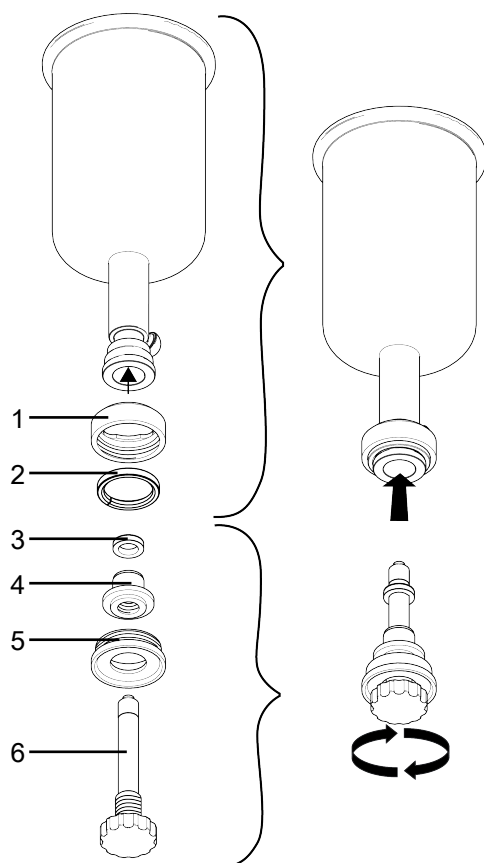

- 1 Slide the pressure screw (5) over the spindle (6).
- 2 Slide the pressure piece (4) over the spindle (6).
- 3 Slide the sealing ring (3) over the spindle (6).
- 4 Slide the connecting nut (1) over the valve joint of the reactor and fix it with the insert ring (2). (Make sure the insert ring is inserted properly!)
- 5 Insert the pre-mounted spindle (6) into the reactor and screw the pressure screw (5) into the connecting nut (hand-tight).
- 6 Screw the spindle into the pressure piece (4).



## 6.6 Exchange PTFE seal in the stirrer adapter

The expected life of the PTFE cord is at minimum 2500 hours of use, replacements can be purchased (Order No. 103547) or it will be replaced during Preventive Maintenance.

- 1 Disassemble the stirrer shaft from the stirrer motor.
- 2 Screw off the pressure screw and take out the old PTFE cord.
- 3 Place the new PTFE cord into the adapter.
- 4 Screw on the pressure screw.
- 5 Reassemble the stirrer.

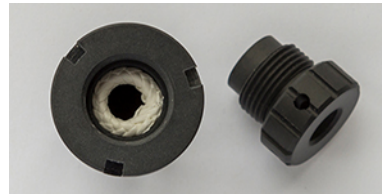

## 6.7 Changing coolant

If you change the coolant, you must rinse and dry the tubing in the instrument before you use the new coolant.

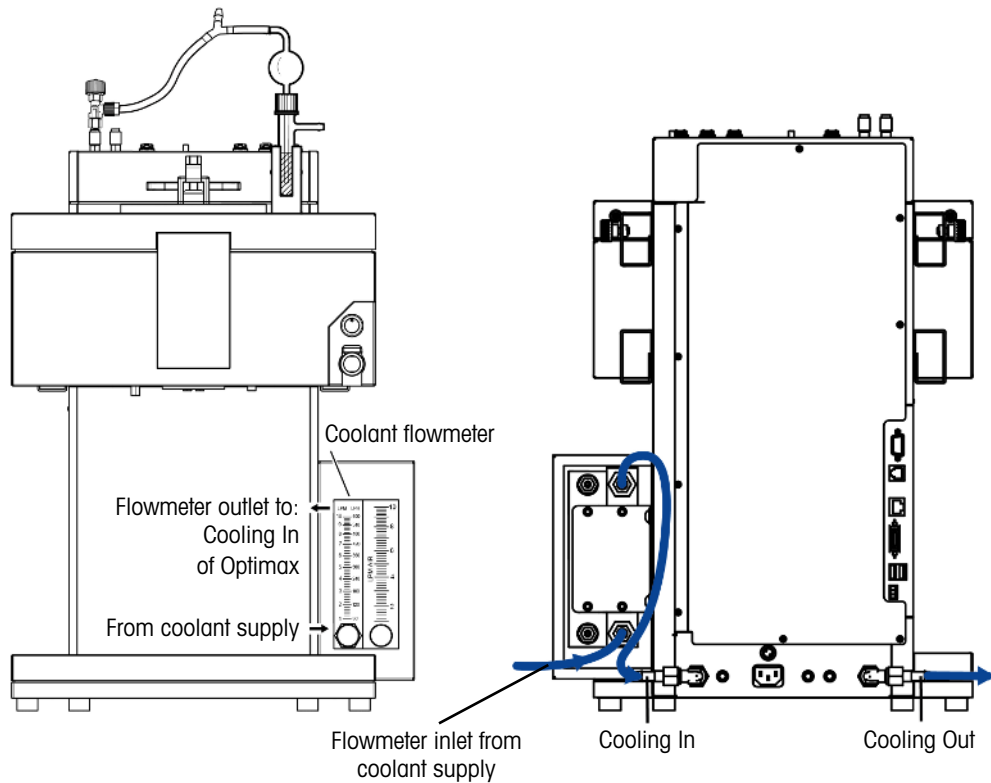

- The device is turned off.
  - The device is disconnected from power.
- 1 Stop the flow from the coolant supply.
  - 2 Remove the connection tube first at the **Cooling In** inlet, and then at the **Cooling Out** outlet.
  - 3 Rinse and dry the tubing in the reverse direction (from the **Cooling Out** outlet).
  - 4 Reconnect the connection tubing to the new coolant supply.
  - 5 Make sure that your system is tight.

## 6.8 Disposal

In conformance with the European Directive 2012/19/EU on Waste Electrical and Electronic Equipment (WEEE) this device may not be disposed of in domestic waste. This also applies to countries outside the EU, per their specific requirements.

Please dispose of this product in accordance with local regulations at the collecting point specified for electrical and electronic equipment. If you have any questions, please contact the responsible authority or the distributor from which you purchased this device. Should this device be passed on to other parties, the content of this regulation must also be related.



## 7 Troubleshooting

Error messages appearing on the touchscreen should offer you a possible counteraction. If this is not the case, please contact the METTLER TOLEDO Service.

Instrument inoperative	If the instrument does not start when you switch it on: <ol style="list-style-type: none"> <li>1 Check the power supply before</li> <li>2 Call the METTLER TOLEDO Service.</li> </ol>
No display on touchscreen	– Make sure the touchscreen cable is connected to the instrument before calling the METTLER TOLEDO Service.
Cooling below T <sub>c</sub> not possible	– Call the METTLER TOLEDO Service.
Wrong T <sub>r</sub> measurement value	<ol style="list-style-type: none"> <li>1 Check the immersion depth: The T<sub>r</sub> sensor must be sufficiently immersed in the reaction mass.</li> <li>2 Check the value with a reference thermometer.            ➔ If its values are correct, the sensor is defective.</li> </ol>
Window of the thermostat fogged	<ol style="list-style-type: none"> <li>1 Make sure the thermostat is purged or increase the purge rate</li> <li>2 For one-piece reactors: use the plug to close the bottom drain hole in the thermostat</li> </ol>
Heating inoperative	If the heater is inoperative: – Call the METTLER TOLEDO Service.
Stirrer adapter stuck on reactor	<ol style="list-style-type: none"> <li>1 Turn the adapter loosening device counter-clockwise until it pushes slightly against the ground joint.</li> <li>2 Carefully turn it further and the stirrer adapter will come loose.</li> </ol>
Stirrer inoperative	If the stirrer does not operate after switching on the instrument: <ol style="list-style-type: none"> <li>1 Make sure the stirrer isn't blocked.</li> <li>2 Call the METTLER TOLEDO Service.</li> </ol>

## 8 Accessories

The synthesis workstation catalog provides a full overview of the available and compatible accessories to your device.

### Temperature sensors



Tr sensor, Alloy C-22, 6.35x300 mm

51162839



Tr sensor glass, 6x300 mm

51162827

### Wear parts



Sealing ring, PTFE  
(Set of 5)

103547



Bottom Drain Connect Set

51162730



Tip, light blue (Lubriflon 904 = filled PTFE)

51190515



Spindle bottom drain valve (with tip), PTFE

51191774

### Calorimetry



Upgrade Kit OptiMax HFCal:

30050150

- Module HFCal
- Calibration heater, Alloy C-22
- Adapter ST19/23 with sealing ring, PTFE
- CAN cable, 100 cm



Calibration heater, Alloy C-22, 8x300 mm

30050155



Module HFCal

30050151

## Dosing and Sampling



ECB

30212440



Dosing unit SP-50

51161770



EasySampler

30083901

## Software

Additional purchased software or upgrade licenses are sent out electronically by e-mail.

## 9 Technical Data

Certifications regarding this product can be found at <https://www.mt.com/us/en/home/search/compliance.html/>  
The product name of your device is the model number.

### Directives, standards and REACH regulation

SVHC candidate substances according to REACH (Article 33)

Material	CAS No.
Decamethylcyclopentasiloxane	541-02-6
Dodecamethylcyclohexasiloxane	540-97-6
Octamethylcyclotetrasiloxane	556-67-2
Lead	7439-92-1

### United States of America

This equipment has been tested and found to comply with the limits for a Class B digital device, pursuant to part 15 of the FCC Rules. These limits are designed to provide reasonable protection against harmful interference in a residential installation. This equipment generates, uses and can radiate radio frequency energy and, if not installed and used in accordance with the instructions, may cause harmful interference to radio communications. However, there is no guarantee that interference will not occur in a particular installation. If this equipment does cause harmful interference to radio or television reception, which can be determined by turning the equipment off and on, the user is encouraged to try to correct the interference by one or more of the following measures:

- Reorient or relocate the receiving antenna. —Increase the separation between the equipment and receiver.
- Connect the equipment into an outlet on a circuit different from that to which the receiver is connected.
- Consult the dealer or an experienced radio/TV technician for help.

Changes or modifications not expressly approved by the party responsible for compliance could void the user's authority to operate the equipment.

### Power supply

<b>AC power adapter rating</b>	Line voltage	100...240 VAC
	Input frequency	50/60 Hz
	Mains supply voltage fluctuations	Up to $\pm 10$ % of the nominal voltage
<b>Instrument rating</b>	Power consumption	Max. 1290 VA

### Connections

<b>USB</b>	Support of USB 2.0
<b>Electrical connectors</b>	RS232, USB, CAN, Ethernet, Safety Relay, Safeguard button and touchscreen
<b>Cable length</b>	Limited to 3 m for RS232, USB, CAN, Ethernet, Safety Relay, Safeguard button and touchscreen
<b>Safety Relay</b>	30 VDC / 1 A
<b>CAN</b>	Max. 2 A

### Ambient Conditions

<b>Humidity</b>	Max. relative humidity 80 % for temperatures up to 31 °C decreasing linearly to 50 % relative humidity at 40 °C, non-condensing
<b>Altitude</b>	Up to 2000 m
<b>Overvoltage category</b>	II
<b>Pollution degree</b>	2
<b>Ambient temperature</b>	5 °C...40 °C
<b>Usage</b>	For indoor use only

## Materials

<b>Cover plate</b>	Stainless steel coated with PFA/FEP
<b>Housing material</b>	Powder-Coated stainless steel
<b>Connectors for purge gas</b>	Stainless steel, nickel-plated brass
<b>Purge gas lines</b>	PVC, FEP, PP, PVDF, PTFE, aluminium, nickel-plated brass
<b>Coolant tubing</b>	PVC, PVDF, copper
<b>Flowmeters</b>	Stainless steel, acrylic, HDPE
<b>Holder for lab bars</b>	Aluminium
<b>LEMO connectors for Tr sensor and overhead stirrer</b>	Chrome-plated brass with protection cap in PSU
<b>Reactor window</b>	Borosilicate glass 3.3
<b>Receptacles for reactors</b>	Anodized aluminum
<b>Fixing rings of thermostats</b>	PTFE C25
<b>Anti twist protection</b>	PEEK HPV and aluminium
<b>USB connector</b>	Stainless steel with protection cap in PSU
<b>On/Off switch</b>	Stainless steel
<b>Stirrershaft, -blade</b>	Borosilicate glass 3.3 or Hastelloy® C-22, PTFE
<b>Overhead stirrer</b>	PTFE, PEEK, aluminum, steel
<b>Tr sensor</b>	Borosilicate glass or Hastelloy® C-22
<b>Reactors</b>	Borosilicate glass 3.3 and PTFE
<b>Touchscreen</b>	PA 12, aluminum
<b>Protective cover for Touchscreen</b>	Barex®

## Device

<b>Weight incl. touchscreen</b>	35 kg
---------------------------------	-------

## Dimensions

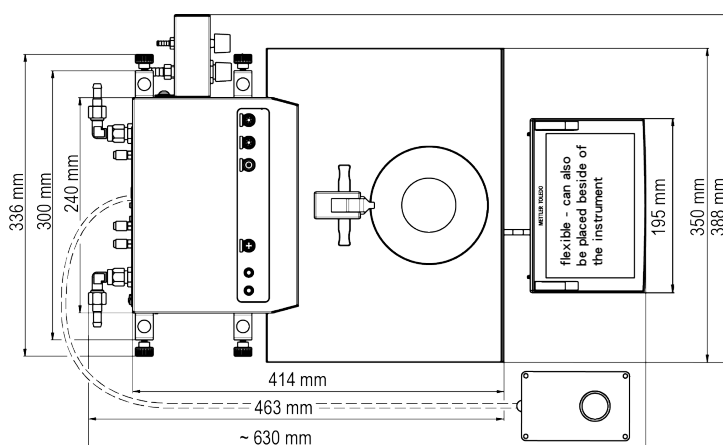

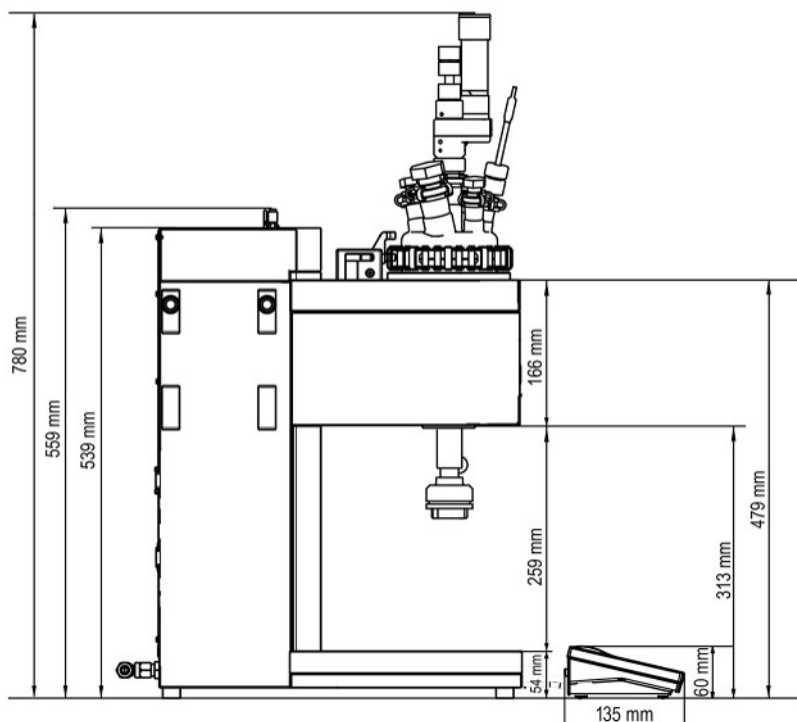

## 9.1 Thermostat

### Temperatures

<b>Range</b>	Tj: -40 °C to 180 °C* Tr: -40 °C to 180 °C* Tc: -40 °C to 60 °C * The temperature range of Tr / Tj is depending on the temperature of the coolant and the cooling power of the used external cooling system.
<b>Resolution</b>	Tj: 0.1 K Tr: 0.1 K
<b>Maximum permissible errors</b>	±1.0 K for the whole range, for Tr and Tj sensor
<b>Data recording interval</b>	Every 2 seconds

## 9.2 Reactors

	1000 mL reactor	500 mL reactor	250 mL reactor
<b>Pressure</b>	0.05 bar to ambient pressure		
Nominal volume (2-piece reactors)	1310 mL	830 mL	370 mL
Nominal volume (1-piece reactor)	1150 mL	700 mL	400 mL
Working volume (with Tr sensor)	150 - 1000 mL	80 - 500 mL	60 - 250 mL

Min. working volumes for reactors equipped with standard Hastelloy temperature sensor and immersion depth of 1.5 cm:

Reactor type	Stirrer Blade	Min. working volume 1000 mL reactor	Min. working volume 500 mL reactor	Min. working volume 250 mL reactor
Two piece	Pitched blade	150 mL	80 mL	60 mL
Two piece	Anchor	320 mL	140 mL	80 mL



One piece	Half-moon	320 mL	120 mL	80 mL
-----------	-----------	--------	--------	-------

### 9.3 Stirrer

Operating mode	Control to constant value or ramp
Speed range	30...1200 rpm
Torque	Max 153 mNm (for continuous operation)
Lifespan	1000...3000 hours of continuous operation

### 9.4 Cooling

Min. Flow of cooling media	2 L/min (at 15 °C)
Cooling types	Tap water or external cooling
Max. pressure of cooling media	<ul style="list-style-type: none"> <li>Without flowmeter: 3.5 bar</li> <li>With flowmeter: 2 bar</li> </ul>

Temperature (Tj)	Cooling power with tap water	Cooling power with external cooling / thermostat
180 °C	Not necessary	Min. 1000 W at 20 °C
20 °C (room temperature)	Not necessary	Min. 1000 W at 10 °C
- 20 °C	Not necessary	Min. 1000 W at 10 °C
- 30 °C	Not recommended	Min 750 W at 0 °C
- 40 °C	Not possible	Min. 750 W at -10 °C

### 9.5 Purge gas

<b>Purge gas housing (Purge Internal)</b>	Max. inlet pressure	0-7 bar*
	Min. gas flow	0-3 L/min
<b>Inert gas reactor (Inert in)</b>	Max. inlet pressure	0-7 bar*
	Min. gas flow	as needed (controlled with the bubbler)
<b>Stirrer (Purge In)</b>		as inert

\* The inlet pressure is limited to 6 bar if the purge gas is connected to the device over the rotameter.





**To protect your product's future:**  
METTLER TOLEDO Service assures  
the quality, measuring accuracy and  
preservation of value of this product  
for years to come.

Please request full details about our  
attractive terms of service.

**www.mt.com**

For more information

**Mettler-Toledo GmbH**

Im Langacher 44  
8606 Greifensee, Switzerland  
[www.mt.com/contact](http://www.mt.com/contact)

Subject to technical changes.  
© Mettler-Toledo GmbH 12/2021  
51712001F



51712001