

## Right the First Time Checklist for Machine Integration

**Weighing is a very accurate and reliable measuring method for filling processes, inventory control and completeness verification. Dedicated high-precision weigh modules seamlessly integrate into production machines and instruments in automated industries. The following checklist provides an overview of the most important points for selection based on scientific criteria and successful integration to achieve the most accurate results.**

A weigh module is a sensor that contains all mechanical and electrical devices needed to determine an accurate weighing result. That includes a load receptor; overload protection; analog to digital conversion; digital signal processing; filtering to eliminate vibration; temperature compensation; and the right data interface to transfer precise weight values to your process-control system.

High-resolution weigh modules with electromagnetic force restoration measuring technology can provide weight results up to several million increments. Their linearity, repeatability and hysteresis are far superior to the often-used strain-gauge technology.

Integrating such high-performance measuring equipment requires thoughtful evaluation, planning and installation to ensure the specified accuracy levels. This checklist briefly addresses the most relevant topics to consider.

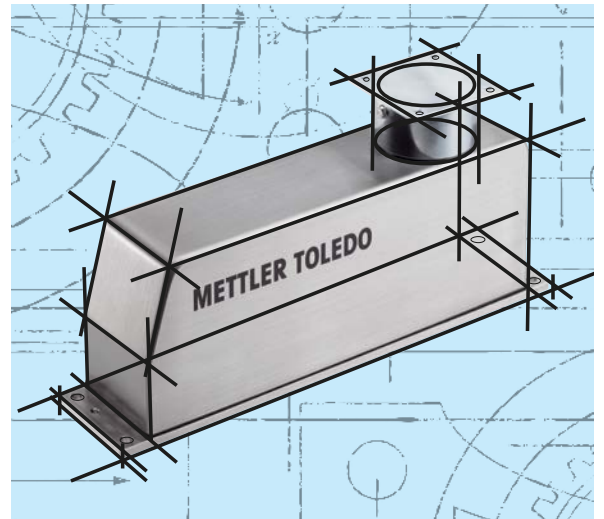

### Contents

---

Selecting the right weigh module

---

Compliance with process tolerance

---

Assuring accuracy over time

---

Mechanical integration criteria

---

Electrical integration criteria

---

Commissioning and serviceability

---

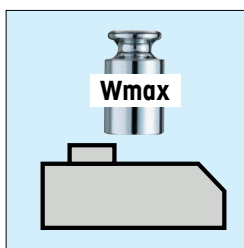

### 1. What is the required weighing capacity?

The required weighing capacity of the weigh module is not only determined by the heaviest product weight. Other factors, such as additional installations or customized weighing pans, have to be added. Therefore, use the following formula:

$$C \geq W_{\max} + WP + WC + WAPL$$

- C: Capacity of the weigh module
- W<sub>max</sub>: Biggest product weight
- WP: Weight of the weighing pan (can be neglected in most cases)
- WC: Weight of the container for weighing multitude products
- WAPL: Additional permanent installation - these are application-specific items. (See also point 2 below)

#### Compact high-precision weigh modules without display are designed for integration into machines.

Therefore, parameter "WP" is zero, because the weighing pan is part of standard delivery and weight is factory adjusted.

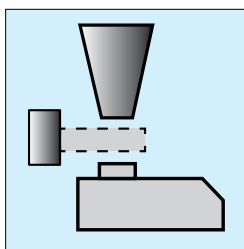

### 2. What is "pre-load" resulting from additional permanent installations?

On top of the weighing pan, machine-integrated weigh modules often carry additional permanent loads [WAPL], such as hoppers, feeders, conveyers or any kind of product holding installations. In those cases, parameter WAPL of the formula above is the weight of an additional device on top of weighing pan.

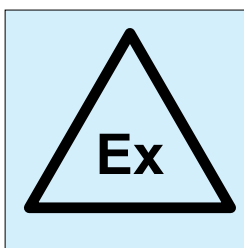

### 3. Is compliance with standards or regulations required?

Complying with quality-management or regulatory standards might require certain weighing accuracy, material standards or certified mechanical or electrical design features. In highly regulated industries in which consumer safety is at stake, such as food, cosmetics and pharmaceutical production, it can mean being subjected to frequent audits to prove compliance.

Installations including weigh modules might need compliance with the following standards:

- GMP requirements for accuracy of weighing equipment
- Hazardous areas: ATEX, FM, CSA
- RoHS (Restriction of Hazardous Substances Directive)
- Hygienic design, such as described in IFS, GMP, BRC, EHEDG and other guidelines
- Risk management based on HACCP or similar approaches



Complying with some of those standards means that the entire machine has to comply, not just the weigh module.

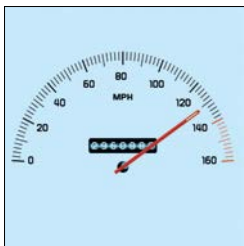
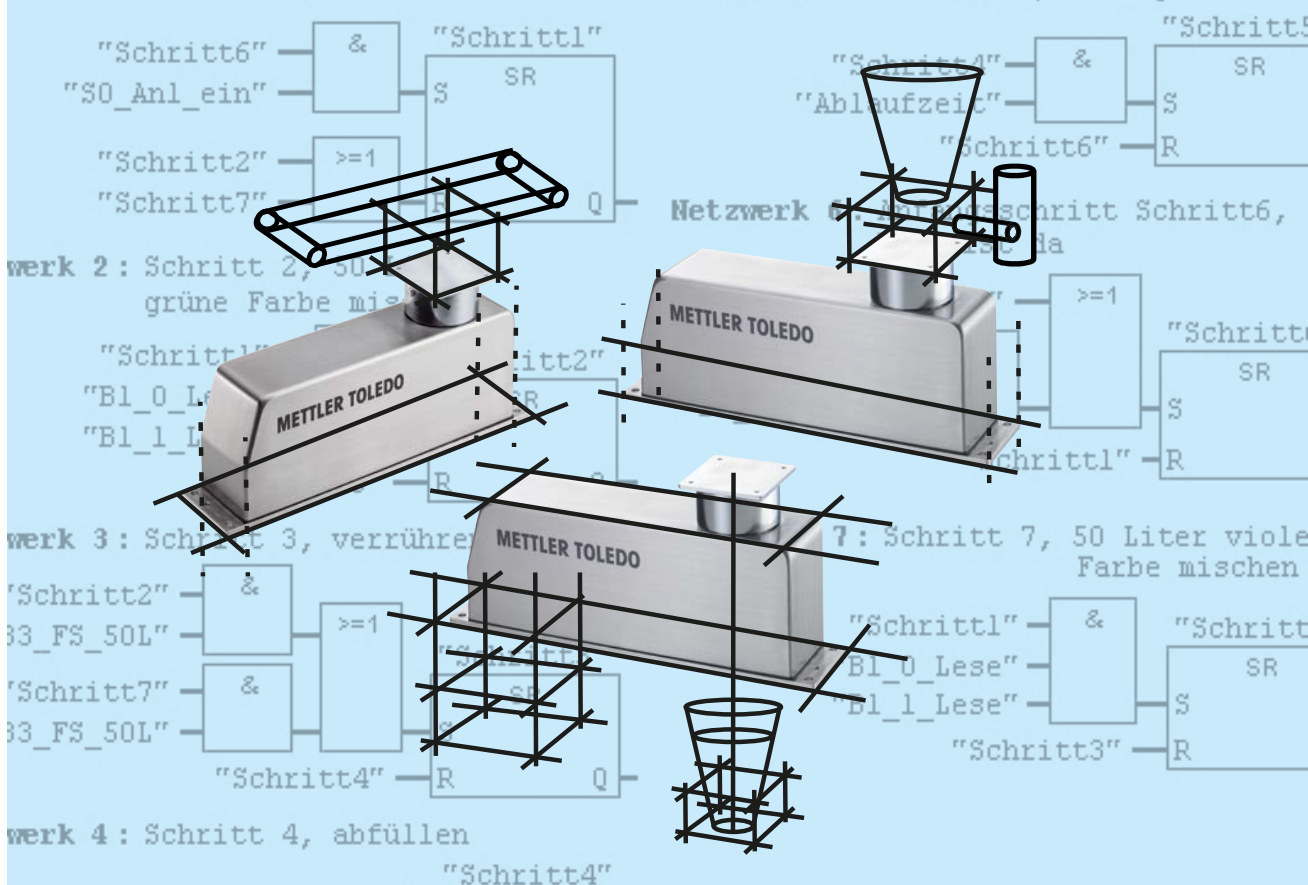

#### 4. Which readability is required?

Readability or displayed resolution is the smallest difference in weight that can be read on a weighing instrument's display or that is transferred via interface to the process-control system. But readability of a weigh module is often mistaken for accuracy. High readability doesn't necessarily mean high accuracy. Therefore, the weigh module should be selected according to the process requirements and the specifications for smallest net weight, repeatability and linearity.

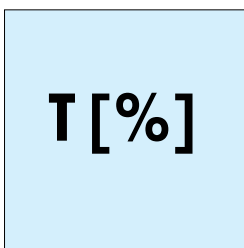

#### 5. What is the accepted process tolerance in percentages?

Quality will be ensured if an instrument's measurement uncertainty is always better than your weighing process tolerance. For example, measuring 1kg with a tolerance of 1% is only possible with a weigh module providing a measurement uncertainty <1% at the given net load of 1kg.

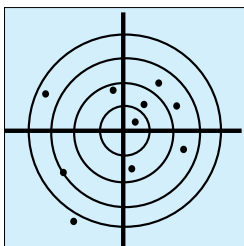

#### 6. Which repeatability do you need?

Repeatability specifically may affect high accuracy weigh modules, whereas for lower accuracy weigh modules (with low resolution) the rounding error dominates. Consequently, the repeatability is most important criteria when selecting a weighing module for high accuracy applications. The repeatability is usually published in the specifications of the weigh module.

Information: Repeatability is calculated as the standard deviation of 10 weight measurements performed under the same conditions and with the same operator.

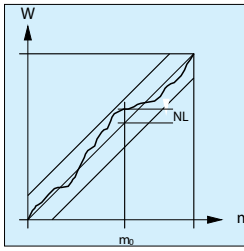

### 7. Which linearity do you need?

Linearity is defined as the ability of a weigh module to follow the linear relationship between a load ( $m$ ) and the indicated value ( $W$ ). Non-linearity (NL) becomes a critical error source when a weighing process uses the entire weighing range (or most of it). The linearity is usually published in the specifications of the weigh module.

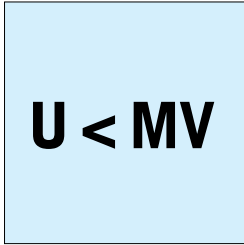

### 8. What is the minimum sample weight that needs to be determined?

The smaller the sample weight, the larger the relative measurement uncertainty becomes. In the low-capacity range of the weigh module, there is a limit under which any measurement will have an uncertainty greater than the acceptable tolerance. Respecting the minimum weight of the weigh module ensures that all measurements are made within the required accuracy. The minimum weight is usually published in the specifications of the weigh module.

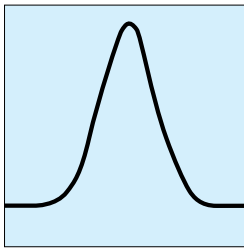

### 9. What is your measurement uncertainty?

The accuracy of a measurement is determined by measurement uncertainty. A simplified formula for measurement uncertainty is:

$$U = 2 \times \sqrt{(V_w + V_r + V_e \cdot W^2 + V_a \cdot W^2 + V_k \cdot W^2)}$$

U: Measurement uncertainty (= inaccuracy)

W: Actual weight placed on the weighing sensor

V<sub>w</sub>: Standard deviation of repeatability

V<sub>r</sub>: Rounding error

V<sub>e</sub>: Deviation of corner load (eccentricity)

V<sub>a</sub>: Deviation of non-linearity

V<sub>k</sub>: Deviation of the calibration weight(s)

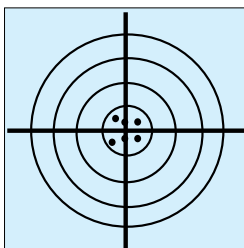

### 10. How do you assure accuracy?

Accuracy is verified, by calibration, to determine if there is a deviation between the true weight value and the measured value. In case a critical deviation is detected, adjustment is necessary. The calibration frequency depends on the individual risks related to incorrect weight results. A process with actions has to be defined, if a deviation exceeds your acceptance criteria based on your process tolerance.

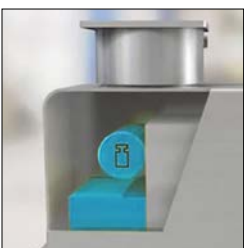

### 11. How do you configure the internal adjustment weight?

Test and adjustment with a weight, which is built into the weigh module, is the most efficient method. It can be initiated by command from the control system via interface or automatically if temperature changed or after a time interval set during configuration. Sophisticated weigh modules can be adjusted with an internal weight, despite a permanent pre-load on the weighing pan, such as a conveyor or a hopper.



## 12. Do you combine calibration with an external test weight?

Test and adjustment can be done by positioning a certified weight onto the weighing pan if the weigh module is accessible inside the machine. However, placing a test weight can be impossible, if an application-specific device is on top of the weighing pan.

It is recommended to combine tests with internal and external weights. The test with the internal weight is used to verify accuracy any time needed. The external test weight is used for traceability and to verify the internal test weight.



## 13. How do you ensure traceability of weights to national or international standards?

Test weights are available with calibration certificates, which show traceability to the national standard, nominal value, conventional mass value, uncertainty, confidence level and the OIML accuracy class of the weight.



## 14. Do you have to document correct selection of the weigh module?

Good Weighing Practice® is the global weighing standard, ensuring consistent accuracy of weighing processes, applicable to new and existing equipment from any manufacturer. It is a risk-based approach that clearly interprets the regulations of each industry and puts them into straightforward weighing practice.

### It supports users in the following topics:

Applying a standardized scientific methodology for secure selection, calibration and operation of weighing equipment for design qualification, installation qualification, operation qualification and performance qualification.



The GWP Recommendation Certificate documents:

- Identification of installation
- Model name of weigh module
- Maximum capacity
- Readability
- Smallest permitted sample weight
- Weighing accuracy in %
- Typical minimum weight
- Your safety factor
- Conformity to standards and regulations
- Test weight for verification
- Accuracy class of test weight

► [www.mt.com/GWP](http://www.mt.com/GWP)

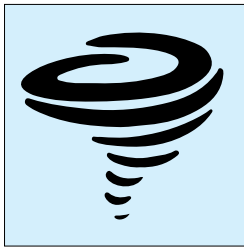

### 15. Is weigh module exposed to draft?

Air currents generate through impact pressure or viscous friction, spurious forces onto the weighing pan, weighing object or installation on top of the weighing pan. A consequence of this effect is the deterioration of the repeatability of the weighing value and it might reduce speed of weighing process. Therefore, it might be necessary to add measures to prevent air currents.

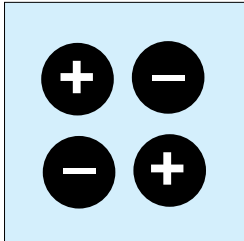

### 16. Is material sensitive to an electrostatic load near the weigh module?

Electrically charged objects or installations on top of the weighing pan can exert an attracting or pushing force to the weighing platform. As a consequence, the weight value can deviate from the actual mass of the object. Therefore, avoid non-conductive materials, such as glass, plastic, aluminum and ceramic.

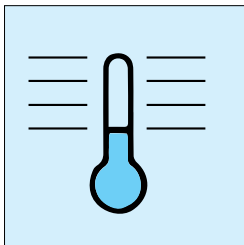

### 17. Are heat- or cold-emitting sources near the weigh module?

A weigh module can detect temperature changes and compensate for them by adjustment of the internal weight. But fast temperature changes might not be compensated for immediately because most production process cannot be interrupted for testing. Therefore, it is best to keep heat- or cold-emitting devices away from the weigh module.

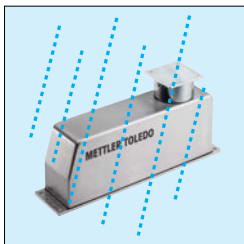

### 18. What are the cleaning requirements for weigh module?

Cleaning can be tedious and costly, but it is crucial in the food and pharmaceutical industries, in which preventing contamination has high priority. A weigh module with IP66 protection is beneficial, especially if CIP (Cleaning In Place) is required. This allows rinsing the weigh module with a liquid cleaning agent without having to dismantle the whole system.

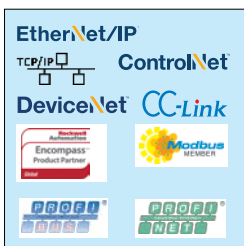

### 19. Which control-system interface technology do you need?

Machine control systems can communicate with weigh modules via serial interfaces. For communicating with PLC systems, it is best to use globally recognized automation standards, such as industrial Ethernet or device networks. Digital Inputs are available for zero setting, tare and weight catch point. Digital outputs change status if weight set point (target) is reached.

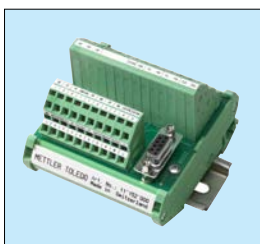

### 20. How do you connect the weigh modules inside a control cabinet?

A dedicated connecting block with status LED for the weigh module inside the control cabinet of the machine makes wiring and commissioning more convenient and efficient. It allows for a fast status check of the weigh module's digital inputs and outputs and for its power supply.

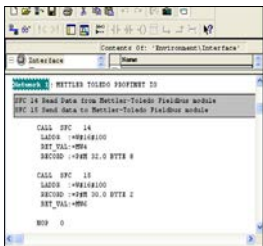
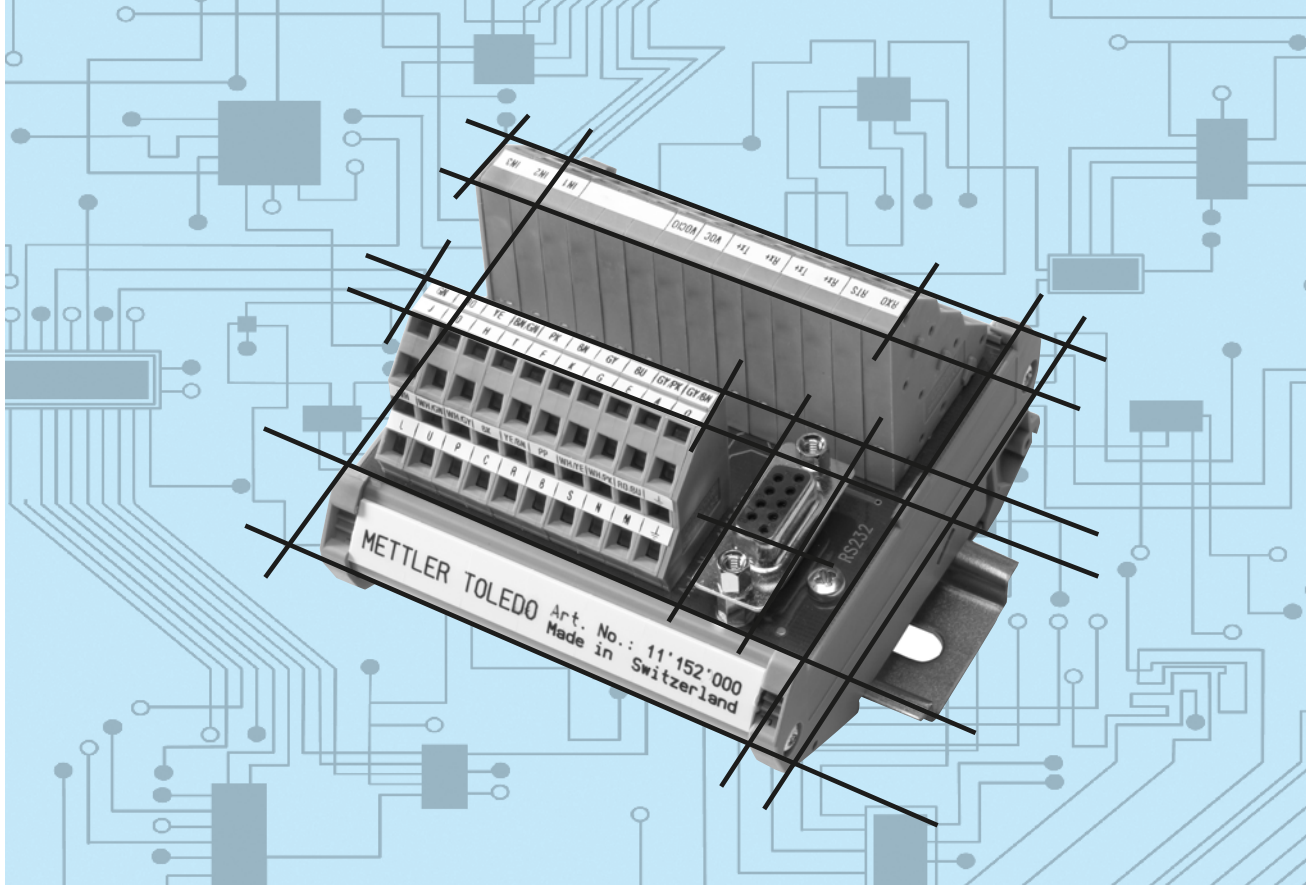

### 21. How do you implement weight values into your PLC program?

Efforts for integrating a weigh module into the PLC (Programmable Logic Controller) programs can be reduced by using add-on profiles, generic station descriptions, faceplates or function blocks. Dedicated fieldbus connectivity modules with integrated command set for weighing speed up commissioning of automation communication.



### 22. How do you access the weigh module for software-configuration monitoring of weight value?

A connector as permanent service access to the weigh module inside the control cabinet facilitates configuration and maintenance. During commissioning, it allows online monitoring of weight value and optimizing of parameters without unplugging the connection between the weigh module and control system.

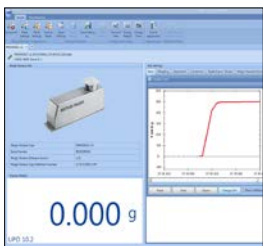

### 23. How do you configure weigh module and how do you backup software settings?

An open, computer-based software-configuration tool facilitates weigh monitoring, configuration and optimization of filter settings to adapt to the environment and to achieve high throughput rates. It can also be used to backup settings and duplicate them into other weigh modules when the functions are identical to reduce setup time.



Watch Video about integrating high precision Weigh Modules into machines.

► [www.mt.com/IND-WMS-Install](http://www.mt.com/IND-WMS-Install)

# The Right Sensors for Automated Weighing



## **Fast – Precise – Rugged – Standardized**

Our high speed high accuracy weigh modules are tailored to the needs of machine and equipment manufacturers for simple electrical and mechanical integration. Standardized interfaces allow easy communication with control systems. The proven ruggedness and the worldwide service network guarantee reliable operation for many years.

► [www.mt.com/APW](http://www.mt.com/APW)

### **Mettler-Toledo AG**

Industrial  
CH 8606 Greifensee  
Switzerland  
Phone +41-44-944 22 11  
Fax +41-44-944 30 60

Subject to technical changes  
©04/2015 Mettler-Toledo AG  
MTSI

[www.mt.com](http://www.mt.com)

For more information