

**METTLER TOLEDO**



# Table of Contents

<b>1</b>	<b>Introduction</b>	<b>9</b>
1.1	Further documents and information .....	9
1.2	Explanation of conventions and symbols used .....	9
1.3	Acronyms and abbreviations .....	10
1.4	Product range .....	10
1.4.1	XPR analytical balances, full-height draft shield .....	10
1.4.2	XPR analytical balances, half-height draft shield .....	11
1.4.3	XPR analytical comparators .....	11
1.5	Compliance information .....	11
<b>2</b>	<b>Safety Information</b>	<b>12</b>
2.1	Definitions of signal words and warning symbols .....	12
2.2	Product-specific safety information .....	12
<b>3</b>	<b>Design and Function</b>	<b>14</b>
3.1	Function description .....	14
3.2	Overview balance .....	15
3.3	Components description .....	16
3.3.1	Draft shield .....	16
3.3.2	Weighing pan .....	16
3.3.3	Drip tray .....	16
3.3.4	Removable clips .....	17
3.3.5	Door handle .....	17
3.3.6	Leveling feet .....	17
3.3.7	Terminal .....	18
3.3.8	Module cover .....	18
3.3.9	Optical sensors .....	18
3.3.10	Side door release lever .....	19
3.4	Overview terminal .....	19
3.5	Overview type label .....	20
3.6	User interface .....	20
3.6.1	Main sections at a glance .....	20
3.6.2	Main weighing screen .....	21
3.6.3	Panel "Balance menu" .....	22
3.6.4	Panel "Methods" .....	22
3.6.5	Panel "Results" .....	23
3.6.6	Icons and symbols .....	24
3.6.6.1	System status icons .....	24
3.6.6.2	Weighing status icons .....	24
3.6.6.3	Process status icons .....	25
<b>4</b>	<b>Installation and Putting into Operation</b>	<b>26</b>
4.1	Selecting the location .....	26
4.2	Unpacking the balance .....	26
4.3	Scope of delivery .....	28
4.4	Installation .....	28
4.4.1	Attaching the terminal .....	28
4.4.2	Assembling the balance .....	29
4.5	Putting into operation .....	31
4.5.1	Connecting the balance .....	31
4.5.2	Switching on the balance .....	32
4.5.3	Logging in .....	32
4.5.4	Leveling the balance .....	33
4.5.5	Performing an internal adjustment .....	33
4.5.6	Entering / Exiting standby mode .....	33

4.5.7	Switching off the balance .....	33
4.6	Performing a simple weighing .....	34
4.6.1	Opening and closing the draft shield doors .....	34
4.6.2	Zeroing the balance.....	34
4.6.3	Taring the balance .....	34
4.6.4	Performing a weighing .....	34
4.6.5	Completing the weighing .....	35
4.7	Transporting, packing and storing.....	35
4.7.1	Transporting the balance over short distances .....	35
4.7.2	Transporting the balance over long distances .....	35
4.7.3	Packing and storing .....	35
4.8	Weighing below the balance.....	36
<b>5</b>	<b>Operation</b> .....	<b>37</b>
5.1	Touch screen .....	37
5.1.1	Selecting or activating an item .....	37
5.1.2	Scrolling .....	37
5.1.3	Using the fly-in panels .....	37
5.1.4	Entering characters and numbers.....	38
5.1.5	Changing the date and time .....	38
5.2	Methods.....	39
5.2.1	Methods overview .....	39
5.2.2	Method "General weighing" .....	39
5.2.2.1	Creating a method "General weighing" .....	40
5.2.2.2	Performing a "General weighing" .....	40
5.2.3	Method "Simple formulation" .....	41
5.2.3.1	Creating a method "Simple formulation" .....	42
5.2.3.2	Performing a "Simple formulation" .....	42
5.2.4	Method "Interval weighing".....	43
5.2.4.1	Creating a method "Interval weighing" .....	43
5.2.4.2	Performing an "Interval weighing" .....	43
5.2.5	Method "Titration" .....	44
5.2.5.1	Creating a method "Titration" .....	44
5.2.5.2	Performing a "Titration".....	45
5.2.6	Method "Density determination" .....	45
5.2.6.1	Creating a method "Density determination" .....	46
5.2.6.2	Performing a "Density determination" .....	46
5.2.7	Method "SQC".....	47
5.2.7.1	Creating a method "SQC" .....	47
5.2.7.2	Performing a "SQC" on packaged goods.....	48
5.2.7.3	Performing a "SQC" with automatic feeder.....	49
5.2.8	Method "Piece Counting" .....	51
5.2.8.1	Creating a method "Piece Counting" .....	52
5.2.8.2	Performing a "Piece Counting".....	52
5.2.9	Method "Automated dosing" .....	53
5.2.9.1	Creating a method "Automated dosing" .....	54
5.2.9.2	Performing an "Automated dosing" with the Q3 dosing module .....	54
5.2.9.3	Performing a series of dosings with the Q3 dosing module and QS3 sample changer .....	56
5.2.10	Method "Automated solution prep." .....	58
5.2.10.1	Creating a method "Automated solution prep." .....	59
5.2.10.2	Performing a solution preparation (dissolve) with the Q3 dosing module .....	59
5.2.10.3	Performing a dilution with the QLX3 liquid module.....	62
5.2.11	Editing a method .....	63
5.2.12	Cloning a method .....	63
5.2.13	Deleting a method.....	64
5.2.14	Deleting a task .....	64
5.2.15	Using methods with multiple weighing items (itemized) .....	64

5.2.15.1	Creating a new method with multiple weighing items (itemized)	65
5.2.15.2	Creating an itemized method from a completed task	65
5.2.15.3	Performing an itemized method	65
5.3	Test weights	65
5.3.1	Defining an individual test weight	65
5.3.2	Defining a combined test weight	66
5.4	Tests	66
5.4.1	Overview routine tests	66
5.4.1.1	Eccentricity test	66
5.4.1.2	Repeatability test	67
5.4.1.3	Sensitivity test	67
5.4.2	Creating a new test	67
5.4.3	Performing a test	67
5.4.3.1	Performing an "Eccentricity test"	68
5.4.3.2	Performing a "Repeatability test"	70
5.4.3.3	Performing a "Sensitivity test"	72
5.4.4	Editing a test	73
5.4.5	Printing test results	73
5.4.6	Deleting a test	74
5.4.7	Consulting the test history	74
5.5	Adjustments	74
5.5.1	Internal adjustment	74
5.5.1.1	Editing an "Internal adjustment"	74
5.5.1.2	Performing an "Internal adjustment"	75
5.5.2	External adjustment	75
5.5.2.1	Editing an "External adjustment"	75
5.5.2.2	Performing an "External adjustment"	75
5.5.3	Consulting the adjustment history	76
5.6	Peripheral devices	76
5.6.1	Printer	76
5.6.1.1	Printing results manually on a strip printer via USB	76
5.6.1.2	Printing results automatically on a label printer via Bluetooth	78
5.6.2	Barcode reader	80
5.6.2.1	Scan a sample ID using a barcode reader	80
5.6.3	RFID reader	81
5.6.3.1	Reading data from an RFID Smart Tag using an EasyScan USB	81
5.6.3.2	Formatting an RFID Smart Tag using a SmartScan	82
5.6.4	Foot switch and ErgoSens	83
5.6.4.1	Opening the draft shield with a foot switch	83
5.6.4.2	Taring the balance with an ErgoSens	84
5.6.5	Pump	84
5.6.6	Editing the settings of a device	85
5.6.7	Deleting a device	85
5.7	Remote control via services	85
5.7.1	LabX service	85
5.7.1.1	Using LabX via a USB connection	86
5.7.1.2	Using LabX via an Ethernet connection	86
5.7.2	MT-SICS service	86
5.7.2.1	Using MT-SICS via a USB connection	87
5.7.2.2	Using MT-SICS via an Ethernet connection	87
5.7.3	Web service	88
5.8	Data management	89
5.8.1	Exporting results	89
5.8.2	Sending individual results to a computer	90
5.8.3	Exporting and importing settings	91
5.8.3.1	Transferring test weight settings between balances	92
5.9	User management	93

5.9.1	Activating the user management .....	93
5.9.2	Disabling the user management .....	93
5.9.3	Managing users and user groups .....	93
5.9.3.1	Creating a new user .....	94
5.9.3.2	Creating a new group .....	94
5.9.3.3	Deleting users or user groups .....	94
5.10	Tolerance profiles .....	94
5.11	Password protection and balance reset .....	95
5.11.1	Password protection .....	95
5.11.1.1	Changing a password .....	95
5.11.1.2	Requesting a reset password .....	95
5.11.1.3	Creating an unblocking password .....	96
5.11.2	Logging in and logging out .....	96
5.11.2.1	Logging in .....	96
5.11.2.2	Logging out .....	96
5.11.3	Blocking and unblocking the balance .....	96
5.11.3.1	Blocking the balance .....	96
5.11.3.2	Unblocking the balance .....	96
5.11.4	Resetting the balance .....	97
5.12	Automated dosing .....	97
5.12.1	Setting the height of the dosing head .....	97
5.12.1.1	Definition of the dosing head positions .....	97
5.12.1.2	HeightDetect .....	98
5.12.1.3	Absolute Dosing position .....	98
5.12.2	Managing the dosing head data .....	99
5.12.3	Changing the pump pressure .....	100
5.12.4	Purging a liquid dosing head .....	101
5.12.5	Controlling the position of the sample changer .....	101
5.12.6	Adjusting the sample changer .....	103
5.13	Pipette calibration .....	104
5.13.1	Using multiple tolerance profiles .....	104

<b>6</b>	<b>Software Description</b>	<b>106</b>
6.1	Balance menu settings .....	106
6.1.1	Leveling aid .....	106
6.1.2	History .....	106
6.1.2.1	Adjustments .....	106
6.1.2.2	Tests .....	107
6.1.2.3	Alibi memory .....	107
6.1.2.4	Service .....	108
6.1.2.5	Changes .....	108
6.1.3	Balance info .....	109
6.1.4	Users .....	109
6.1.4.1	General .....	109
6.1.4.2	Users .....	110
6.1.4.3	Groups .....	110
6.1.5	Settings .....	111
6.1.5.1	Balance .....	112
6.1.5.2	Modules / Dosing .....	119
6.1.5.3	Interfaces .....	120
6.1.5.4	Devices / Printers .....	121
6.1.5.5	LabX / Services .....	123
6.1.5.6	Printing the settings .....	123
6.1.6	Maintenance .....	124
6.1.6.1	Service menu .....	124
6.2	Weighing methods settings .....	125
6.2.1	Settings: method "General weighing" .....	125
6.2.1.1	General .....	125

6.2.1.2	ID format .....	126
6.2.1.3	Weighing .....	126
6.2.1.4	Weighing item / Weighing items .....	129
6.2.1.5	Automation .....	129
6.2.1.6	Print / Export .....	131
6.2.2	Settings: method "Simple formulation" .....	136
6.2.2.1	General .....	136
6.2.2.2	Formulation .....	136
6.2.2.3	ID format .....	138
6.2.2.4	Weighing .....	139
6.2.2.5	Weighing item .....	139
6.2.2.6	Weighing items .....	140
6.2.2.7	Automation .....	141
6.2.2.8	Print / Export .....	142
6.2.3	Settings: method "Interval weighing" .....	146
6.2.3.1	General .....	146
6.2.3.2	Interval .....	146
6.2.3.3	ID format .....	147
6.2.3.4	Weighing .....	147
6.2.3.5	Weighing item .....	148
6.2.3.6	Automation .....	148
6.2.3.7	Print / Export .....	148
6.2.4	Settings: method "Titration" .....	149
6.2.4.1	General .....	149
6.2.4.2	Titration .....	149
6.2.4.3	ID format .....	150
6.2.4.4	Weighing .....	151
6.2.4.5	Weighing item .....	152
6.2.4.6	Automation .....	152
6.2.4.7	Print / Export .....	154
6.2.5	Settings: method "Density determination" .....	158
6.2.5.1	General .....	158
6.2.5.2	Density .....	158
6.2.5.3	ID format .....	159
6.2.5.4	Weighing .....	160
6.2.5.5	Weighing item .....	161
6.2.5.6	Automation .....	162
6.2.5.7	Print / Export .....	163
6.2.6	Settings: method "SQC" .....	165
6.2.6.1	General .....	165
6.2.6.2	ID format .....	165
6.2.6.3	Weighing .....	166
6.2.6.4	Weighing item .....	168
6.2.6.5	Automation .....	169
6.2.6.6	Print / Export .....	171
6.2.7	Settings: method "Piece Counting" .....	173
6.2.7.1	General .....	173
6.2.7.2	ID format .....	173
6.2.7.3	Weighing .....	174
6.2.7.4	Weighing item .....	175
6.2.7.5	Automation .....	176
6.2.7.6	Print / Export .....	178
6.2.8	Settings: method "Automated dosing" .....	182
6.2.8.1	General .....	182
6.2.8.2	Dosing .....	182
6.2.8.3	ID format .....	183
6.2.8.4	Weighing .....	184

6.2.8.5	Weighing item / Weighing items .....	186
6.2.8.6	Automation .....	186
6.2.8.7	Print / Export .....	187
6.2.9	Settings: method "Automated solution prep." .....	190
6.2.9.1	General .....	191
6.2.9.2	Solution .....	191
6.2.9.3	ID format .....	193
6.2.9.4	Weighing .....	194
6.2.9.5	Weighing item / Weighing items .....	195
6.2.9.6	Automation .....	197
6.2.9.7	Print / Export .....	197
6.3	Test weights settings .....	201
6.3.1	Settings: individual test weight .....	201
6.3.2	Settings: combined test weight .....	202
6.4	Tests settings .....	202
6.4.1	Settings: Eccentricity .....	202
6.4.2	Settings: Repeatability test .....	206
6.4.3	Settings: Sensitivity test .....	209
6.5	Adjustments settings .....	213
<b>7</b>	<b>Maintenance</b> .....	<b>216</b>
7.1	Maintenance tasks .....	216
7.2	Cleaning .....	216
7.2.1	Disassembling for cleaning .....	216
7.2.2	Cleaning agents .....	218
7.2.3	Cleaning the balance .....	219
7.2.4	Putting into operation after cleaning .....	219
7.3	Service .....	220
7.4	Software update .....	220
7.4.1	Updating the software .....	220
7.4.2	Restoring the software to the previous version .....	220
7.4.3	Putting into operation after software update .....	220
<b>8</b>	<b>Troubleshooting</b> .....	<b>221</b>
8.1	Error messages .....	221
8.2	Error symptoms .....	223
8.3	Putting into operation after fixing an error .....	224
<b>9</b>	<b>Technical Data</b> .....	<b>225</b>
9.1	General data .....	225
9.2	Explanatory notes for the METTLER TOLEDO AC/DC adapter .....	226
9.3	Model-specific data .....	227
9.3.1	XPR analytical balances .....	227
9.3.2	XPR analytical balances in use with MCP-R pipette calibration module .....	231
9.4	Dimensions .....	232
9.4.1	XPR analytical balances, full-height draft shield .....	232
9.4.2	XPR analytical balances, half-height draft shield .....	233
9.4.2.1	Readability 0.002 mg .....	233
9.4.2.2	Readability 0.01 mg .....	234
<b>10</b>	<b>Disposal</b> .....	<b>235</b>
<b>11</b>	<b>Accessories and Spare Parts</b> .....	<b>236</b>
11.1	Accessories .....	236
11.1.1	XPR analytical balance, full-height draft shield .....	236
11.1.2	XPR analytical balance, half-height draft shield .....	244
11.2	Spare parts .....	249
11.2.1	Weighing chamber, full-height draft shield .....	249



11.2.2	Weighing chamber, half-height draft shield .....	250
11.2.3	Miscellaneous .....	251
11.2.4	Packaging .....	252
<hr/>		
<b>12</b>	<b>Appendix</b>	<b>253</b>
12.1	Approved balances .....	253
12.1.1	Definitions .....	253
12.1.2	Descriptive markings .....	253
12.1.3	Restrictions on zeroing and taring .....	253
12.1.4	Factory method: General Weighing .....	253
12.1.5	Representation of weighing results .....	254
12.1.6	MT-SICS .....	255
12.1.7	Reference .....	255
<hr/>		
	<b>Index</b>	<b>257</b>



# 1 Introduction

Thank you for choosing a METTLER TOLEDO balance. The balance combines high performance with ease of use.

This document is based on the software version V 2.0.501.

## Disclaimer for comparators

In this document, the term "balance" is used to describe both balances and comparators.

Comparators are characterized by their higher resolution compared to balances. They are mainly used for differential weighing applications, such as the calibration of standard weights. Beside standard balance tests, comparators have also been tested with differential repeatability (ABA repeatability) during production.

## EULA

The software in this product is licensed under the METTLER TOLEDO End User License Agreement (EULA) for Software.

When using this product you agree to the terms of the EULA.

▶ [www.mt.com/EULA](http://www.mt.com/EULA)

## 1.1 Further documents and information

This document is available in other languages online.

▶ [www.mt.com/XPR-analytical-RM](http://www.mt.com/XPR-analytical-RM)

Product page:

▶ [www.mt.com/XPR-analytical](http://www.mt.com/XPR-analytical)

Instructions for cleaning a balance, "8 Steps to a Clean Balance":

▶ [www.mt.com/lab-cleaning-guide](http://www.mt.com/lab-cleaning-guide)

Search for software:

▶ [www.mt.com/labweighing-software-download](http://www.mt.com/labweighing-software-download)

Search for documents:

▶ [www.mt.com/library](http://www.mt.com/library)

For further questions, please contact your authorized METTLER TOLEDO dealer or service representative.

▶ [www.mt.com/contact](http://www.mt.com/contact)

## 1.2 Explanation of conventions and symbols used

### Conventions and symbols

Key and/or button designations and display texts are shown in graphic or bold text, e.g., , **Edit**.

 **Note** For useful information about the product.



Refers to an external document.

### Elements of instructions

In this manual, step-by-step instructions are presented as follows. The action steps are numbered and can contain prerequisites, intermediate results and results, as shown in the example. Sequences with less than two steps are not numbered.

■ Prerequisites that must be fulfilled before the individual steps can be executed.

1 Step 1

➔ Intermediate result

2 Step 2

➔ Result

### 1.3 Acronyms and abbreviations



Original term	Explanation
AC	Alternating Current
ASTM	American Society for Testing and Materials
DC	Direct Current
EMC	Electromagnetic Compatibility
FCC	Federal Communications Commission
GWP	Good Weighing Practice
HID	Human Interaction Device
ID	Identification
LED	Light-Emitting Diode
LPS	Limited Power Source
MAC	Media Access Control
MT-SICS	METTLER TOLEDO Standard Interface Command Set
NA	Not Applicable
OIML	Organisation Internationale de Métrologie Légale (International Organization of Legal Metrology)
RAM	Random Access Memory
RFID	Radio-frequency identification
RM	Reference Manual
SELV	Safety Extra Low Voltage
SOP	Standard Operating Procedure
SQC	Statistical Quality Control
UM	User Manual
USB	Universal Serial Bus
USP	United States Pharmacopeia

### 1.4 Product range

#### 1.4.1 XPR analytical balances, full-height draft shield

Balance	Models designation
	Readability: <b>0.005 mg</b> • XPR226DR
	Readability: <b>0.01 mg</b> • XPR105 • XPR205 • XPR225DR
	Readability: <b>0.05 mg</b> • XPR305DR
	Readability: <b>0.1 mg</b> • XPR204

## 1.4.2 XPR analytical balances, half-height draft shield

Balance	Models designation
	Readability: <b>0.002 mg</b> <ul style="list-style-type: none"> <li>• XPR106DUH</li> <li>• XPR106DUHR <sup>1</sup></li> </ul>
	Readability: <b>0.01 mg</b> <ul style="list-style-type: none"> <li>• XPR105DUHR <sup>1</sup></li> </ul>

1) only available in combination with the MCP-R pipette calibration module

## 1.4.3 XPR analytical comparators

Balance	Models designation
	Readability: <b>0.005 mg</b> <ul style="list-style-type: none"> <li>• XPR226CDR</li> </ul>

## 1.5 Compliance information

National approval documents, e.g., the FCC Supplier Declaration of Conformity, are available online and/or included in the packaging.

► [www.mt.com/ComplianceSearch](http://www.mt.com/ComplianceSearch)

Contact METTLER TOLEDO for questions about the country-specific compliance of your instrument.

► [www.mt.com/contact](http://www.mt.com/contact)

### United States of America

This equipment has been tested and found to comply with the limits for a **Class A** digital device, pursuant to part 15 of the FCC Rules. These limits are designed to provide reasonable protection against harmful interference when the equipment is operated in a commercial environment. This equipment generates, uses, and can radiate radio frequency energy and, if not installed and used in accordance with the instruction manual, may cause harmful interference to radio communications. Operation of this equipment in a residential area is likely to cause harmful interference in which case the user will be required to correct the interference at his own expense.

This device complies with Part 15 of the FCC Rules. Operation is subject to the following two conditions:

1. This device may not cause harmful interference.
2. This device must accept any interference received, including interference that may cause undesired operation.

Changes or modifications not expressly approved by the party responsible for compliance could void the user's authority to operate the equipment.

## 2 Safety Information

Two documents named "User Manual" and "Reference Manual" are available for this instrument.

- The User Manual is printed and delivered with the instrument.
- The electronic Reference Manual contains a full description of the instrument and its use.
- Keep both documents for future reference.
- Include both documents if you transfer the instrument to other parties.

Only use the instrument according to the User Manual and the Reference Manual. If you do not use the instrument according to these documents or if the instrument is modified, the safety of the instrument may be impaired and Mettler-Toledo GmbH assumes no liability.

### 2.1 Definitions of signal words and warning symbols

Safety notes contain important information on safety issues. Ignoring the safety notes may lead to personal injury, damage to the instrument, malfunctions and false results. Safety notes are marked with the following signal words and warning symbols:

#### Signal words

<b>DANGER</b>	A hazardous situation with high risk, resulting in death or severe injury if not avoided.
<b>WARNING</b>	A hazardous situation with medium risk, possibly resulting in death or severe injury if not avoided.
<b>CAUTION</b>	A hazardous situation with low risk, resulting in minor or moderate injury if not avoided.
<b>NOTICE</b>	A hazardous situation with low risk, resulting in damage to the instrument, other material damage, malfunctions and erroneous results, or loss of data.

#### Warning symbols



General hazard



Notice

### 2.2 Product-specific safety information

#### Intended use

This instrument is designed to be used by trained staff. The instrument is intended for weighing purposes. Any other type of use and operation beyond the limits of use stated by Mettler-Toledo GmbH without consent from Mettler-Toledo GmbH is considered as not intended.

#### Responsibilities of the instrument owner

The instrument owner is the person holding the legal title to the instrument and who uses the instrument or authorizes any person to use it, or the person who is deemed by law to be the operator of the instrument. The instrument owner is responsible for the safety of all users of the instrument and third parties.

Mettler-Toledo GmbH assumes that the instrument owner trains users to safely use the instrument in their workplace and deal with potential hazards. Mettler-Toledo GmbH assumes that the instrument owner provides the necessary protective gear.

## Safety notes



### **WARNING**

#### **Death or serious injury due to electric shock**

Contact with parts that carry a live current can lead to death or injury.

- 1 Only use the METTLER TOLEDO power cable and AC/DC adapter designed for your instrument.
- 2 Connect the power cable to a grounded power outlet.
- 3 Keep all electrical cables and connections away from liquids and moisture.
- 4 Check the cables and the power plug for damage and replace them if damaged.



### **NOTICE**

#### **Damage to the instrument or malfunction due to the use of unsuitable parts**

- Only use parts from METTLER TOLEDO that are intended to be used with your instrument.

## 3 Design and Function

### 3.1 Function description

The XPR line comprises a range of balances that differ from each other due to their weighing range and resolution. The balances of the XPR line combine a large number of weighing and adjustment possibilities with a simple operation handling.

The following features are common to all models of the XPR analytical line:

- fully automatic adjustment using internal weights
- built-in level sensor and leveling aid for fast and easy leveling
- 7-inch capacitive color TFT-touch screen
- various methods that can be defined individually
- various routine tests that can be defined individually
- functions to manage user groups and user rights
- history about performed tests and adjustments, as well as changes applied to the balance settings
- Motor driven side doors and also top door.
- easily removable draft shield elements
- Built-in SmartSens optical sensors for touchless door operation.
- Integrated StaticDetect functionality for the detection of electrostatic charges inside the draft shield .



### 3.2 Overview balance

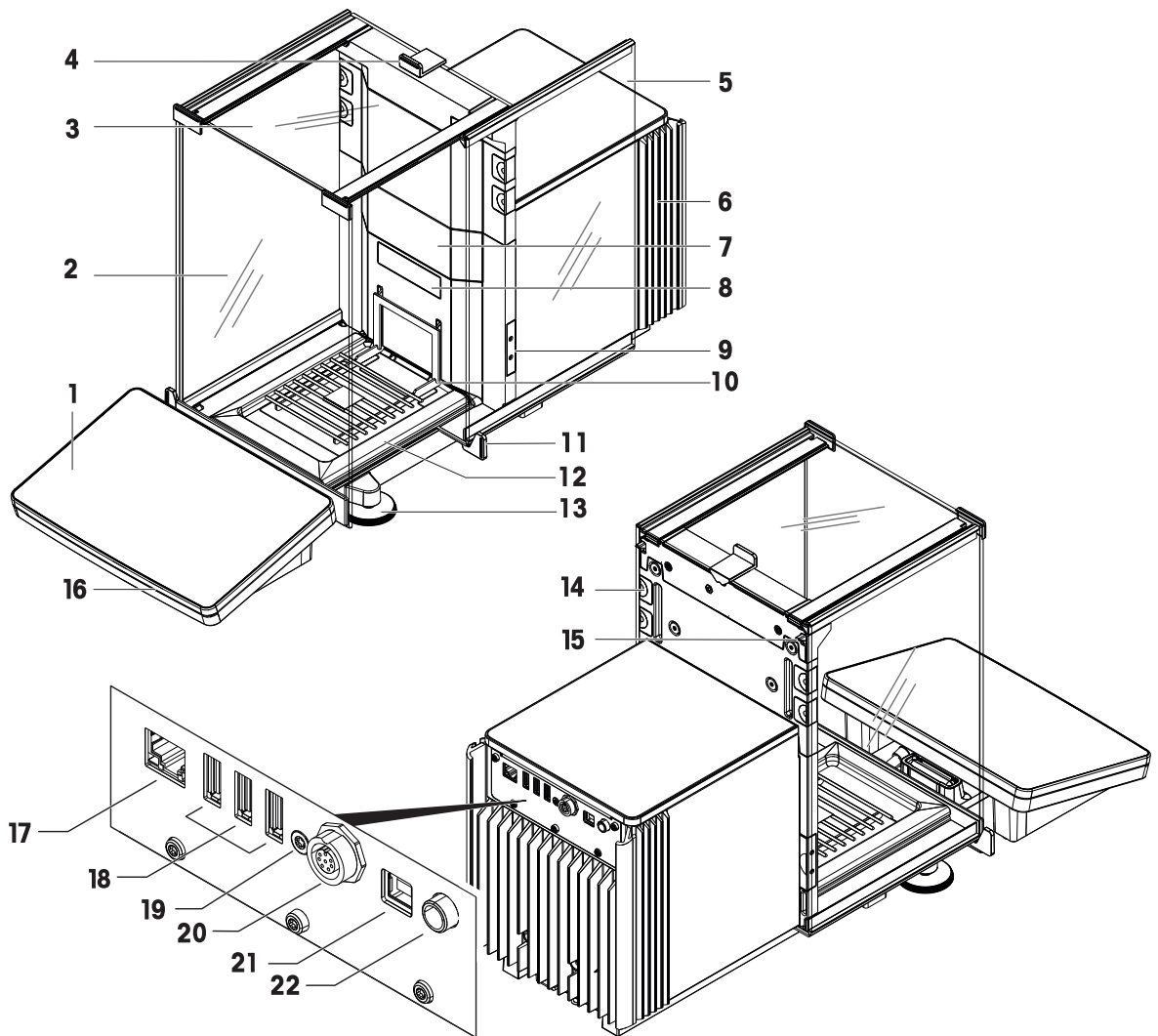

<b>1</b>	Terminal	<b>12</b>	Drip tray
<b>2</b>	Front panel draft shield	<b>13</b>	Leveling feet
<b>3</b>	Top door draft shield	<b>14</b>	Removable clips
<b>4</b>	Handle for top door	<b>15</b>	Side door release lever
<b>5</b>	Side door draft shield (right/left)	<b>16</b>	StatusLight
<b>6</b>	Cooling unit	<b>17</b>	Ethernet port
<b>7</b>	Slot for the installation of an internal module e.g., ionizer module	<b>18</b>	USB-A ports (to device)
<b>8</b>	Model label	<b>19</b>	Service seal
<b>9</b>	Optical sensor SmartSens	<b>20</b>	Socket for terminal connection cable
<b>10</b>	SmartGrid weighing pan	<b>21</b>	USB-B port (to host)
<b>11</b>	Door handle	<b>22</b>	Socket for AC/DC adapter

### 3.3 Components description

#### 3.3.1 Draft shield

The draft shield is a housing device that protects the weighing area against environmental impacts like drafts or moisture. The side doors and the top door can be opened manually or automatically with a touchless sensor.

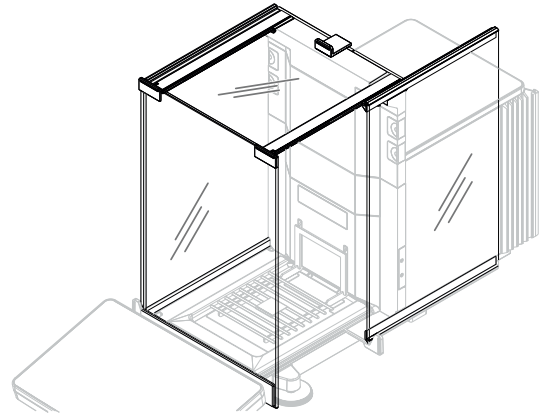

#### 3.3.2 Weighing pan

The SmartGrid weighing pan is the load receptor that serves directly to accommodate the weighing item.

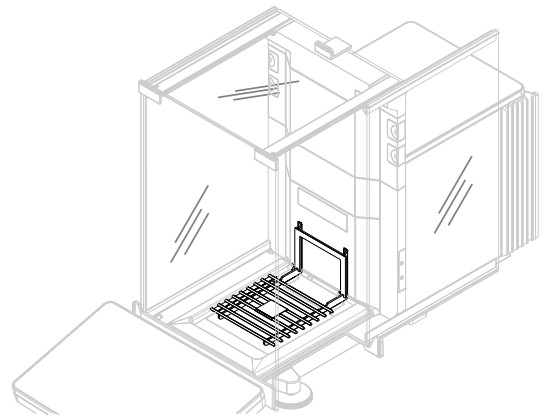

#### 3.3.3 Drip tray

The drip tray is positioned below the weighing pan on the weighing chamber base plate. The primary purpose of the drip tray is to ensure quick cleaning of the balance. Furthermore, this StaticDetect drip tray can be used to detect electrostatic charges.

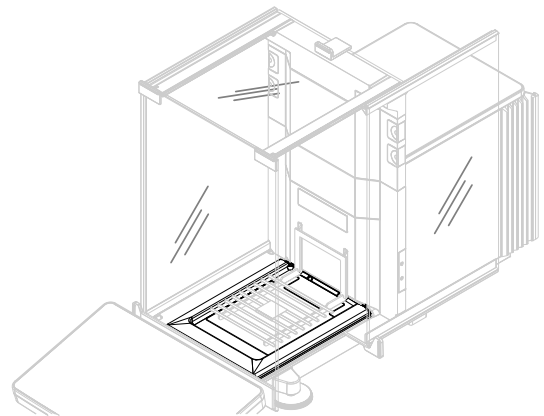

### 3.3.4 Removable clips

The removable clips help to insert cables or measurement devices like sensors or an ionizer into the weighing chamber without opening the doors of the draft shield.

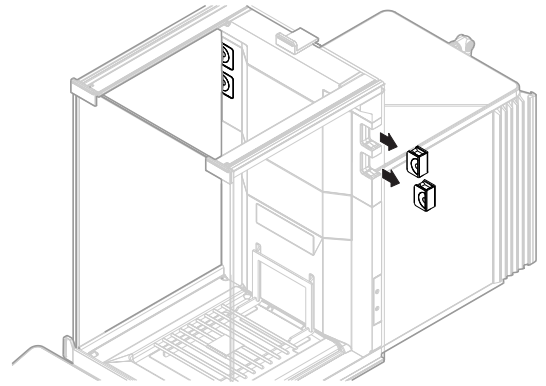

### 3.3.5 Door handle

The door handles are mounted on the door slides and are used to open the side and top doors of the draft shield manually.

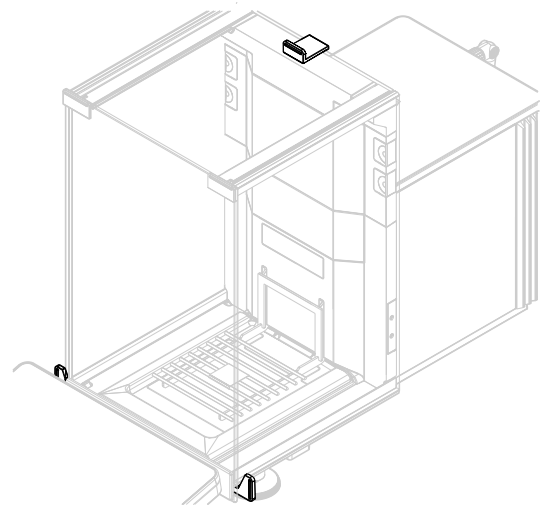

### 3.3.6 Leveling feet

The balance stands on two height-adjustable feet. These feet are used to level the balance.

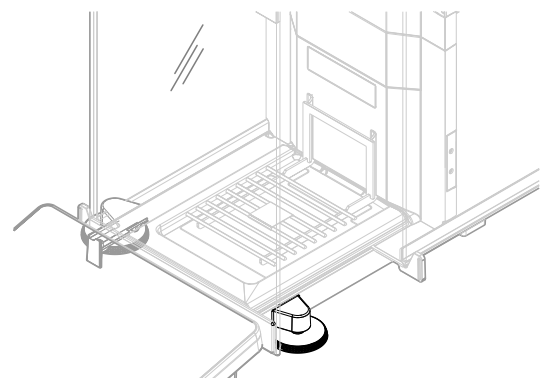

### 3.3.7 Terminal

The 7-inch balance terminal has a touch-sensitive display. Further, on the front side of the terminal is a StatusLight LED strip that indicates the current status of the balance.



### 3.3.8 Module cover

The module cover is a removable cover that covers a plug-in slot. The latter can be used to connect various accessories like an ionizer.

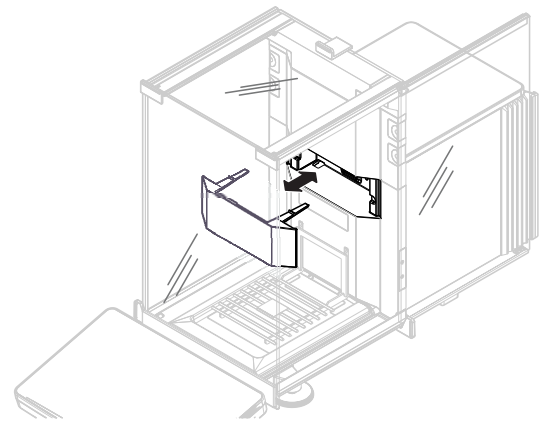

### 3.3.9 Optical sensors

The SmartSens optical sensors are located on the weighing unit, behind the side doors, and provide a touchless door handling. When the optical sensors are activated, the doors can be opened/closed without touching them by moving the hand over the sensor.

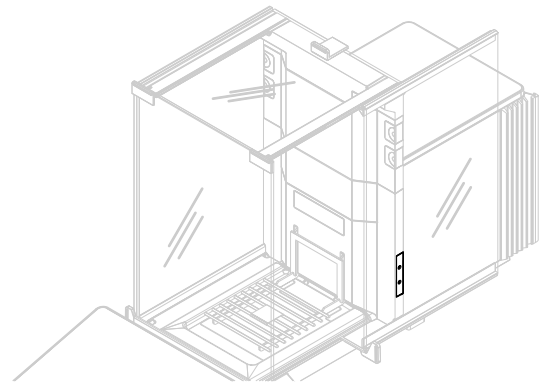





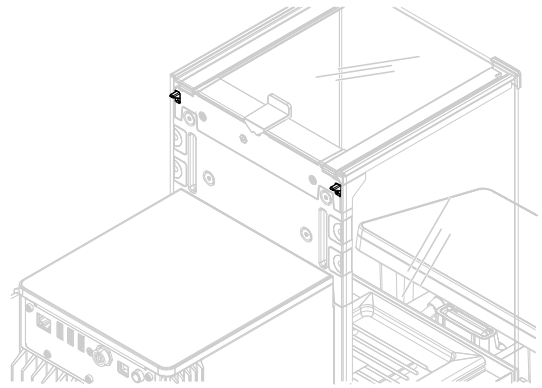

### 3.3.10 Side door release lever

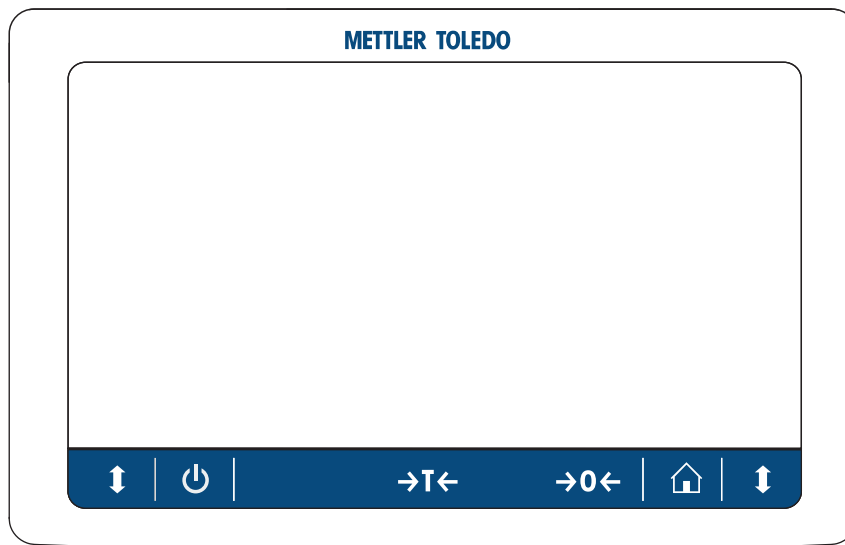
The side door release lever is located on the back side of the partition panel and locks/unlocks the draft shield side door.



### 3.4 Overview terminal



	Name	Description
	Standby	By tapping  , the balance is not completely switched off but goes into standby mode. To switch the balance completely off, it must be unplugged from the power supply. <b>Note</b> Do not disconnect the balance from the power supply unless the balance is not used for an extended period of time. After switching on the instrument, it must warm up before giving accurate results.
	Tare	Tares the balance. This function is used when the weighing process involves containers. After taring the balance, the screen shows <sup>Net</sup> which indicates that all displayed weights are net.
	Zero	Zeroes the balance. The balance must always be zeroed before starting the weighing process. After zeroing, the balance sets a new zero point.
	Home	To return from any menu level to the main weighing screen.
	Open/close door	Opens the weighing chamber door to the left or to the right (default value).

### 3.5 Overview type label

The information on the type label helps to identify the balance and terminal.

#### Type label of the terminal

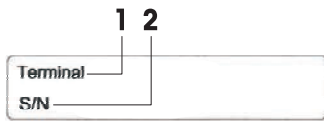

1. Terminal type
2. Terminal serial number

#### Type label of the balance

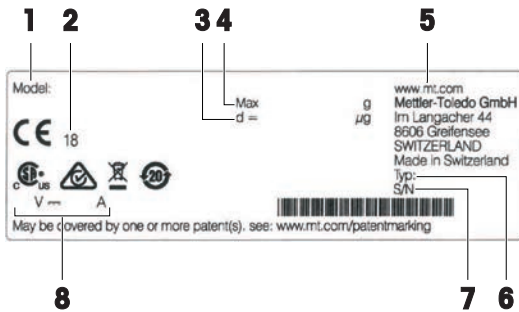

1. Balance model
2. Year of manufacture
3. Readability
4. Maximum capacity
5. Manufacturer
6. Balance type
7. Balance serial number
8. Power consumption

### 3.6 User interface

#### 3.6.1 Main sections at a glance

The main weighing screen (1) is the central navigation point where all the menus and settings can be found. The **Balance menu** (2), **Methods** (3) and **Results** (4) open when tapping the tabs along the sides of the main weighing screen.

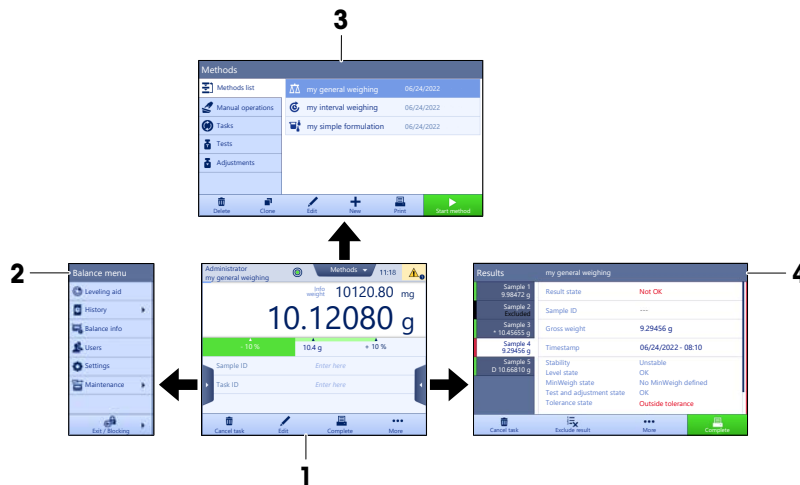

#### See also

- [Main weighing screen](#) ▶ Page 21
- [Panel "Balance menu"](#) ▶ Page 22
- [Panel "Methods"](#) ▶ Page 22
- [Panel "Results"](#) ▶ Page 23

### 3.6.2 Main weighing screen



	Name	Description
1	<b>User name</b>	Shows the name of the current user.
2	Weighing value field	Shows the current weighing value.
3	Level indicator	Indicates if the balance is leveled (green) or not (red).
4	<b>Methods</b> menu	Accesses the user-defined list of methods, tests, and alignments.
5	<b>Info weight</b>	Shows the current weighing value in another unit.
6	Warning and error message area	Shows current warning and/or error messages.
7	<b>Results list</b>	Shows the weighing results saved for this task.
8	Sample status <b>OK</b>	Result status indicator green: indicates that the result fulfills a set of criteria. For example: <ul style="list-style-type: none"> <li>The balance is in level.</li> <li>The internal adjustment was performed and ok.</li> <li>The weighing result is within the defined tolerance range (only if tolerance is defined).</li> </ul>
9	Sample status <b>Excluded</b>	Result status indicator black: indicates that the result was excluded from the <b>Results list</b> .
10	Sample status <b>Not OK</b>	Result status indicator red: indicates that the result criteria are not fulfilled, e.g., "The weighing result was out of the defined tolerances".
11	Button <b>Add result</b>	Adds the result to the <b>Results list</b> . Depending on the selected method, the button can have different functions.
12	Action bar	Contains actions referring to the current task.
13	<b>Balance menu</b>	Accesses the balance properties.
14	Method information area	Contains information about the sample, method or task IDs.
15	SmartTrac	Used as a weighing aid to define a target weight with upper and lower tolerances.
16	Weighing value area	Shows the results of the current weighing process.
17	<b>Method name</b>	Shows the name of the current method.

### 3.6.3 Panel "Balance menu"

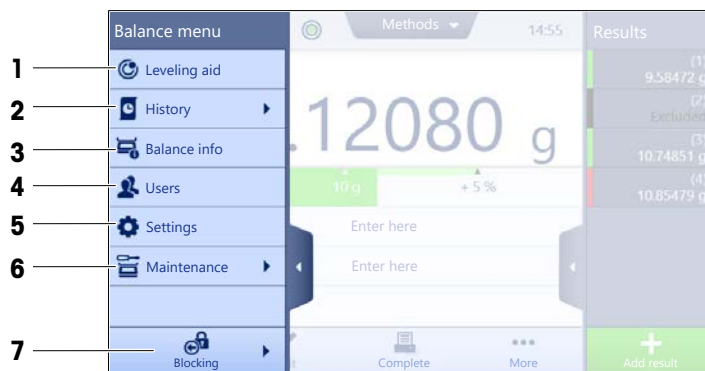

	Name	Description
1	<b>Leveling aid</b>	Opens the leveling dialog.
2	<b>History</b>	Opens the history dialog.
3	<b>Balance info</b>	Shows the balance information.
4	<b>Users</b>	Opens the user management.
5	<b>Settings</b>	Opens the complete settings dialog.
6	<b>Maintenance</b>	Opens the balance maintenance dialog.
7	<b>Exit / Block balance</b>	Opens the logout / block balance dialog.

### 3.6.4 Panel "Methods"



	Name	Description
1	<b>Methods list</b>	Lists the methods already defined by the user. Methods can be created, edited, cloned, started, or deleted.
2	<b>Manual operations</b>	For automated weighing, this menu shows operations that can be performed manually. Depending on the available hardware, this can include: <ul style="list-style-type: none"> <li>• <b>Manage dosing head data</b></li> <li>• <b>Adjust sample changer</b></li> </ul>
3	<b>Tasks</b>	A method/task can be started and then a task is associated with this method. There can be up to one task for each method.
4	<b>Tests</b>	Lists the tests already defined by the user. <ul style="list-style-type: none"> <li>• Sensitivity tests</li> <li>• Repeatability tests</li> <li>• Eccentricity tests</li> </ul> Routine tests can be created, edited, started, or deleted. A list of the tests previously performed is available in the <b>History</b> .



	Name	Description
5	Adjustments	Shows the currently selected internal or external adjustment. The adjustment can be edited or started. A list of the adjustments previously performed is available in the <b>History</b> .

#### See also

[History](#) ▶ Page 106

### 3.6.5 Panel "Results"







	Name	Description
1	Result state	Shows the state of the weighing process.
2	Sample ID	Shows the <b>Sample ID</b> of the weighing.
3	Gross weight	Shows the gross weight. <b>D</b> : indicates that the value was unstable. This might occur when the <b>Weighing mode</b> is set to <b>Immediate</b> . <b>*</b> : indicates that the value was calculated. This might occur, for example, when the <b>Tare Mode</b> is set to <b>Preset tare</b> .
4	Timestamp	Shows the individual timestamp of each weighing item.
5	Balance status	Shows stability, level state of the balance, minimum weight, tolerance state and test and adjustment state.
6	Complete	Opens the dialog <b>Complete task</b> . <ul style="list-style-type: none"> <li>• <b>Print task label manually</b></li> <li>• <b>Print results manually</b></li> <li>• <b>Export results manually</b></li> </ul>
7	More	Opens the dialog <b>More</b> . <ul style="list-style-type: none"> <li>• <b>Start adjustment</b></li> <li>• <b>Change display unit</b></li> <li>• <b>Configure tare</b></li> <li>• <b>Configure zero</b></li> <li>• <b>Save as method (itemized)</b> (only available for methods with the option <b>Weighing items</b>)</li> </ul>
8	Exclude result	Excludes the current result from the <b>Results list</b> . A comment can be added to the excluded result, e.g., to describe the reason of the exclusion. Depending on the format of the results printout, the excluded result can be printed or not.

	Name	Description
9	Cancel task	Cancels the current running task.

### 3.6.6 Icons and symbols







#### 3.6.6.1 System status icons







System messages can appear due to a user action, a user input or a system process. Some messages leave it up to the user to choose upon acting, they will disappear after acknowledging. Other messages remain persistent, so the user can defer them but eventually has to handle them. These messages can be seen in the main status bar on the upper right-hand side of the display.

Icon	Name	Description
	Levelled	More details about the leveling status are displayed when tapping the level status.
	Out of level	The balance must be leveled. Information about leveling the balance can be found in the section [Leveling the balance ▶ Page 33].
	Information	Information messages appear due to user actions or system processes and offer opportunities that are related to the current action or process.
	Warning	Warning messages appear due to user actions or system processes that could lead to a problem that can be prevented.
	Error	Error messages appear due to user actions or system processes that have failed. It is mostly still possible to handle such a problem.

#### 3.6.6.2 Weighing status icons





Weighing status icons appear due to the weight value matching certain quality criteria. The information on the status can be looked by tapping on any of the visible weighing status icons.

Icon	Name	Description
	Stability indicator	When the stability indicator appears, the balance is not stable. Make sure that the balance is placed at an adequate location. Information about the adequate location can be found in the section Selecting the location.
Net	Net indicator	Appears when the tare key has been pressed and the tare weight has been subtracted.
	Calculated value	The current weight value is calculated. This symbol only appears in the weighing value area when a container has been used with the function <b>Preset tare</b> .
	Minimum weight violation	The current weight value is smaller than the defined minimum weight. Make sure that the weight is larger than the minimum weight.
	Balance invalid	The current balance configuration is invalid or quality criteria have not been fulfilled according to the GWP approved definition.
	Weight not ready	The current weight measurement is not ready according to the GWP approved definition. This can be caused by an overload, an underload, or a minimum weight violation.
	Weight ready	The current weight measurement is ready according to the GWP approved definition. It can be added to the <b>Results list</b> .

	StaticDetect ongoing	The electrostatic detection (StaticDetect) test is currently ongoing.
	StaticDetect detected charges	The electrostatic detection (StaticDetect) test detected more charges than the specified threshold.
	StaticDetect passed	The electrostatic detection (StaticDetect) test detected less charges than the specified threshold.
	StaticDetect failed	The electrostatic detection (StaticDetect) test could not be completed.
	External ionizer discharging	The external ionizer is currently discharging.
	Internal ionizer discharging	The internal ionizer is currently discharging.

### 3.6.6.3 Process status icons

The status of the processes running on the balance is indicated by a small icon on the bottom right corner of the icon of the associated process. This applies to **Tasks**, **Tests**, and **Adjustments**.

Icon	Name	Description
	Running	The process is currently running.
	Paused	The process is paused.
	Scheduled	The process is scheduled.
	Information	Information is available about the process, e.g., a reminder.
	Overdue	The process is overdue.

## 4 Installation and Putting into Operation

### 4.1 Selecting the location

A balance is a sensitive precision instrument. The location where it is placed will have a profound effect on the accuracy of the weighing results.

#### Requirements of the location

Place indoors on stable table



Avoid direct sunlight

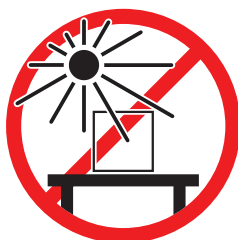

Ensure sufficient spacing

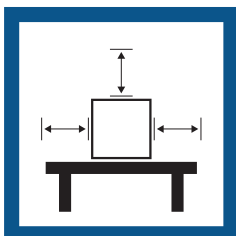

Avoid vibrations



Level the instrument



Avoid strong drafts



Provide adequate lighting

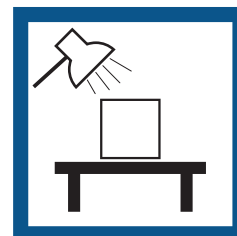

Avoid temperature fluctuations



Sufficient spacing for balances: > 15 cm all around the instrument

Take into account the environmental conditions. See "Technical Data".

### 4.2 Unpacking the balance

Check the package, the packaging elements and the delivered components for damages. If any components are damaged, please contact your METTLER TOLEDO service representative.

#### Note

Depending on the balance model, the components may look different. The procedure is always the same.

- 1 Open the box and lift the package out using the lifting strap (1).

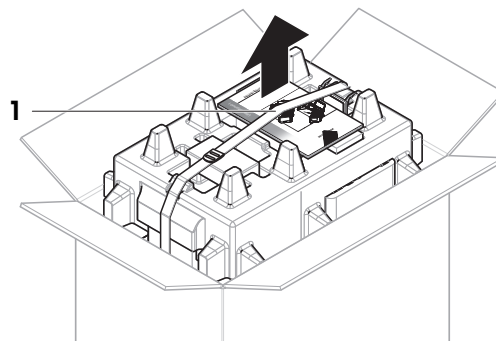

- 2 Open the lifting strap (1) and remove the User Manual (2).

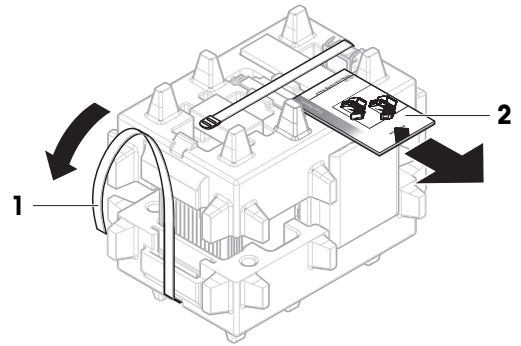

- 3 Remove the upper part of the package and remove the set with the AC adapter and power cable (3), the box containing several accessories (4), and the weighing pan (5).

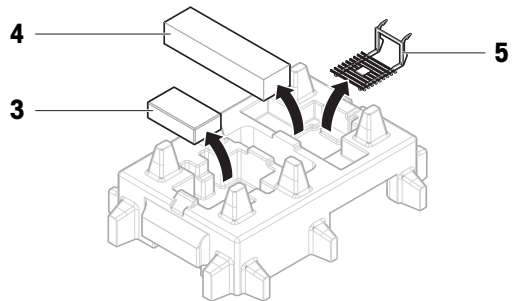

- 4 Carefully remove the terminal (6).

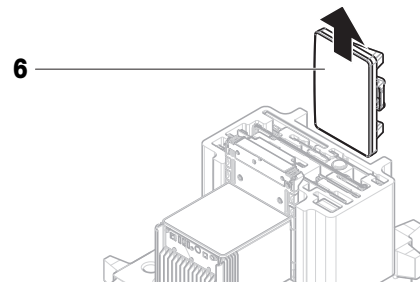

- 5 Carefully remove the package set with the draft shield doors and the display holder (7).

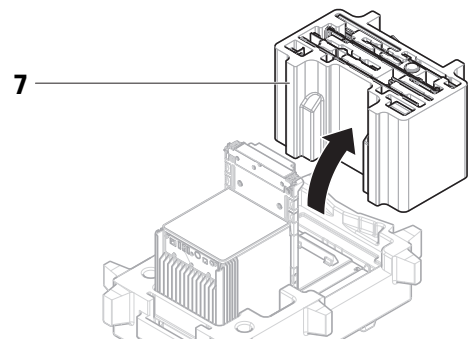

- 6 Carefully remove the platform (8) from the bottom packaging.

- 7 Remove the protective bag.

- 8 Store all parts of the packaging in a safe place for future use.

➔ The platform is ready for assembling.

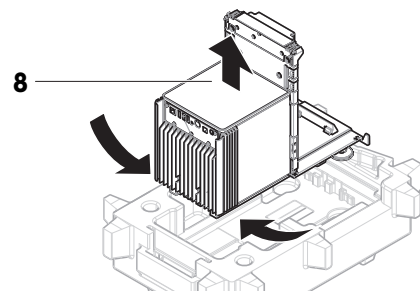

## 4.3 Scope of delivery

### Balance

- Weighing unit
- Draft shield
- Drip tray and weighing pan
- Terminal with terminal holder and terminal connection cable
- AC/DC adapter with country-specific power cable
- MC Link Software (only comparators)

### Documentation

- User Manual
- Declaration of Conformity
- Production certificate

### Accessories

- ErgoClip basket <sup>1,2</sup>
- Brush
- SmartPrep <sup>2</sup>, 2 pcs

1) not for XPR106DUH

2) not for XPR105DUHR and XPR106DUHR

## 4.4 Installation

### 4.4.1 Attaching the terminal



### NOTICE

#### Damage to the cables due to careless handling

- Do not kink or twist the cables.

- 1 Insert the slides of the display holder (1) into the front of the platform (2).

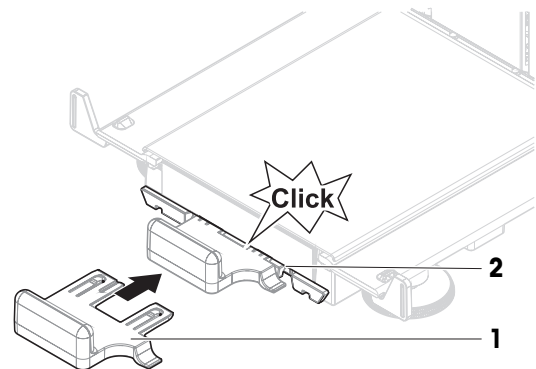

- 2 Connect the terminal cable (3) with the terminal (4). Consider the pin assignment.

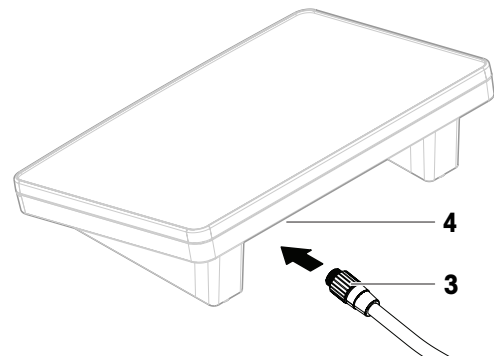

- 3 Place the terminal (5) onto the terminal holder (6).

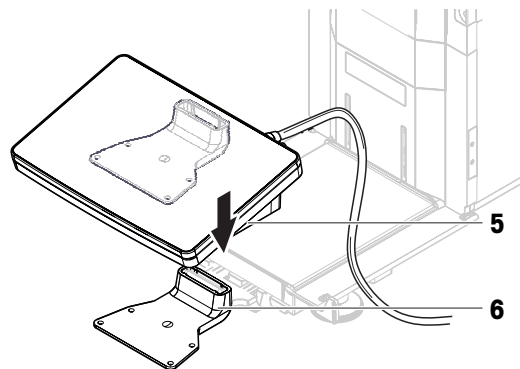

- 4 Carefully tilt the balance to its side.  
5 Lead the cable (7) through the cable channel (8).  
6 Carefully put the balance back on its feet.

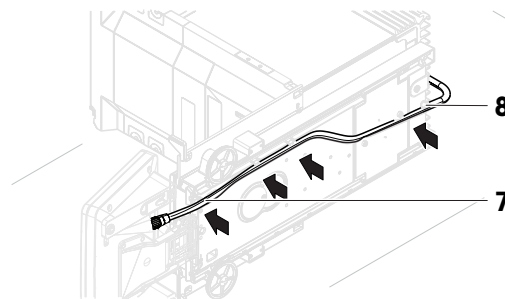

- 7 Insert the plug of the terminal cable (9) into the socket of the balance (10).  
➔ The terminal is ready.

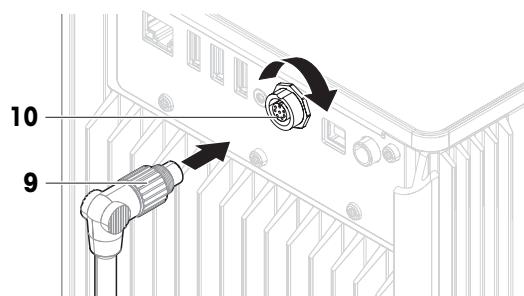

#### 4.4.2 Assembling the balance



#### **CAUTION**

##### **Injury due to sharp objects or broken glass**

- Instrument components, e.g., glass, can break and lead to injuries.  
– Always proceed with focus and care.

**i Note**

Depending on the balance model, the components may look different. The procedure is always the same.

- 1 Insert the drip tray (1).
- 2 Carefully mount the weighing pan (2).

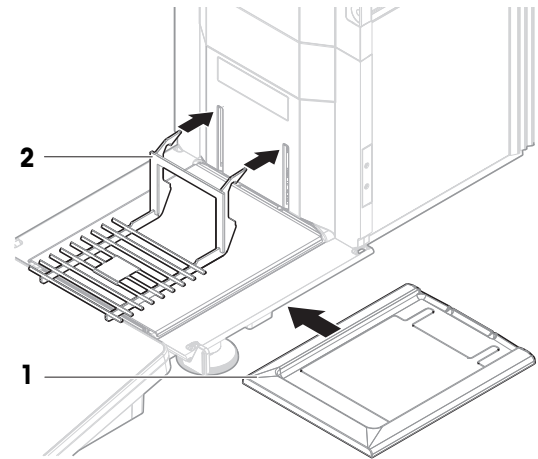

- 3 Place the side doors (3) into the grooves of the door slides (4) and tilt them up until they engage with the door lever (5). Consider the marks on the bottom frames (L = left / R = right).

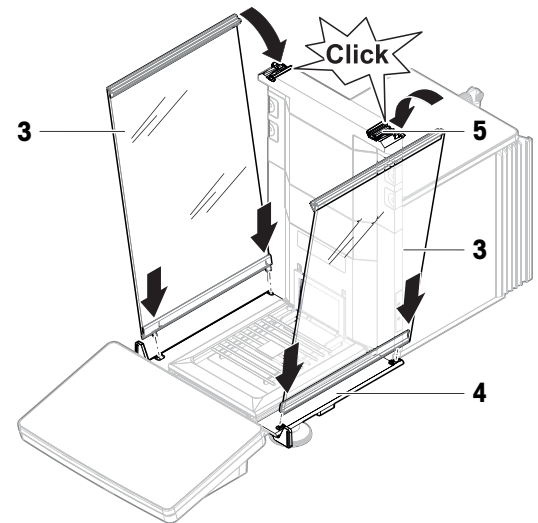

- 4 Insert the front panel (6) into the grooves (7) and tilt it up until it engages.
- 5 Open the side doors.

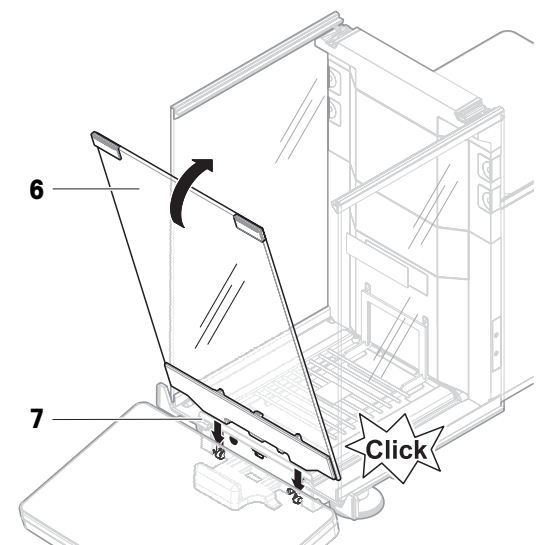



- 6 Fit the top door (8) along the top frame of the side doors and into the rails of the back wall (9).
  - 7 Push the top door (8) towards the front.
  - 8 Close the side doors.
- ➔ The balance is assembled and ready to be put into operation.

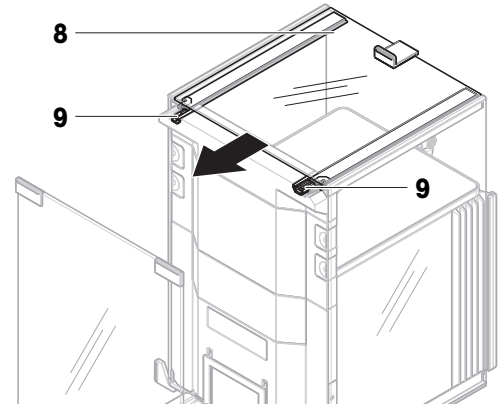

## 4.5 Putting into operation

### 4.5.1 Connecting the balance



#### **WARNING**

##### **Death or serious injury due to electric shock**

Contact with parts that carry a live current can lead to death or injury.

- 1 Only use the METTLER TOLEDO power cable and AC/DC adapter designed for your instrument.
- 2 Connect the power cable to a grounded power outlet.
- 3 Keep all electrical cables and connections away from liquids and moisture.
- 4 Check the cables and the power plug for damage and replace them if damaged.

- 1 Install the cables in such a way that they cannot be damaged or interfere with operation.
  - 2 Insert the plug of the AC/DC adapter (1) into the power socket of the instrument.
  - 3 Secure the plug by firmly tightening the knurled nut.
  - 4 Insert the plug of the power cable into a grounded power outlet that is easily accessible.
- ➔ The balance automatically switches on.
- ➔ The draft shield opens and closes for initialization.

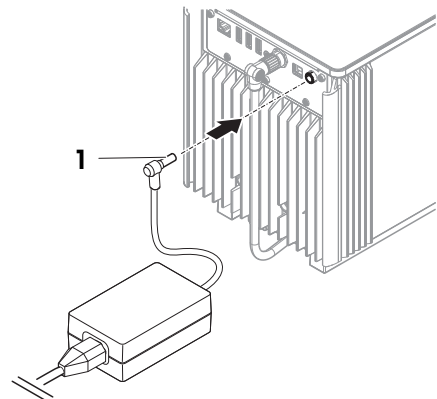

#### **Note**

Do not connect the instrument to a power outlet controlled by a switch. After switching on the instrument, it must warm up before giving accurate results.

#### **See also**

🔗 General data ▶ Page 225

## 4.5.2 Switching on the balance

When connected to the power supply, the balance automatically switches on.

### EULA (End User License Agreement)

When the balance is switched on the first time, the EULA (End User License Agreement) appears on the screen.

- 1 Read the conditions.
- 2 Tap **I accept the terms in the license agreement.** and confirm with **✓ OK.**
  - ➔ The main weighing screen appears.

### Acclimatization and warm up

Before the balance gives reliable results, it must:



- acclimatize to the room temperature
- warm up by being connected to the power supply

The acclimatization time and warm-up time for balances and comparators are available in "General data".

#### **Note**

When the balance is exiting standby, it is ready immediately.

### See also

-  [General data](#) ▶ Page 225
-  [Entering / Exiting standby mode](#) ▶ Page 33

## 4.5.3 Logging in



If the user management is activated, you have to log in with your **User name** before performing a weighing. When the balance starts, the login dialog opens automatically.

- 1 Select a user or tap **User name.**
- 2 Tap **Password.**
  - ➔ The input dialog opens.
- 3 Enter your password and tap **✓ OK.**
- 4 Tap  **Login.**
  - ➔ The login dialog closes and you are logged in. Your **User name** is shown on the main screen.

The user management can be activated through the balance menu:

**≡ Navigation:** ▶ **Balance menu** >  **Settings** >  > **Balance** >  **General** > **User management**

### See also

-  [Activating the user management](#) ▶ Page 93
-  [Users](#) ▶ Page 109

#### 4.5.4 Leveling the balance

Exact horizontal and stable positioning are essential for repeatable and accurate weighing results.

If the message **Balance is out of level** appears:

- 1 Tap ► **Level the balance**.
  - ➔ The **Leveling aid** opens.
- 2 Turn both leveling feet (1) as instructed on the display until the dot is in the center of the level indicator.

The leveling aid can also be accessed through the **Balance menu**:

☰ **Navigation:** ► **Balance menu** > ⦿ **Leveling aid**

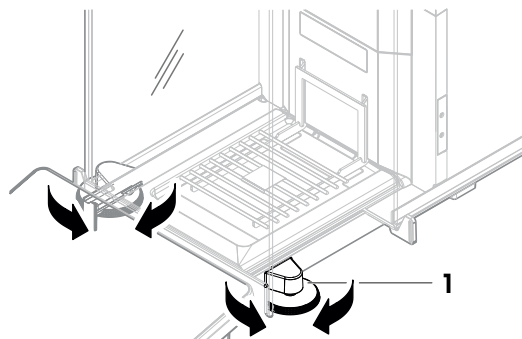

#### 4.5.5 Performing an internal adjustment

☰ **Navigation:** ▼ **Methods** > ⚙ **Adjustments**

- The adjustment **Strategy** is set to **Internal adjustment**.
- 1 Open the **Methods** section, tap ⚙ **Adjustments**, select the adjustment, and tap ► **Start**  
- or -  
from the main weighing screen, tap ⋮ **More** and tap **Start adjustment**.
    - ➔ **Internal adjustment** is being executed.
    - ➔ When the adjustment has been completed, an overview of the adjustment results appears.
  - 2 Tap 🖨 **Print** if you want to print the results.
  - 3 Tap ✓ **Finish adjustment**.
    - ➔ The balance is ready.

#### 4.5.6 Entering / Exiting standby mode

- 1 To enter standby mode, hold ⏻.
  - ➔ The display is dark. The balance is still switched on.
- 2 To exit standby mode, press ⏻.
  - ➔ The display is turned on.

#### 4.5.7 Switching off the balance

To completely switch off the balance, it must be disconnected from the power supply. By holding ⏻, the balance goes only into standby mode.

##### i **Note**

When the balance was completely switched off for some time, it must warm up before it can be used.

##### **See also**

🔗 Switching on the balance ► Page 32

## 4.6 Performing a simple weighing

### 4.6.1 Opening and closing the draft shield doors

- Open the door manually with the door handle (1) or touch the key  $\updownarrow$  on the terminal (2).

The doors can be configured to open and close in different ways.

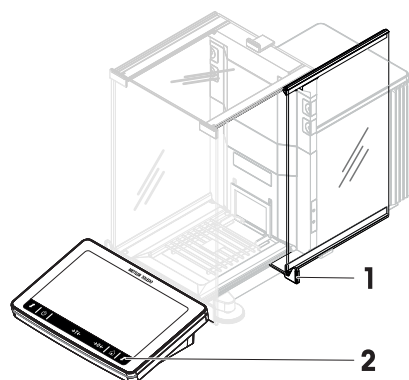

#### See also

[Doors](#) ▶ Page 116

### 4.6.2 Zeroing the balance

- 1 Open the draft shield.
  - 2 Clear the weighing pan.
  - 3 Close the draft shield.
  - 4 Press  $\rightarrow 0 \leftarrow$  to zero the balance.
- ➔ The balance is zeroed.

### 4.6.3 Taring the balance

If a sample vessel is used, the balance must be tared.

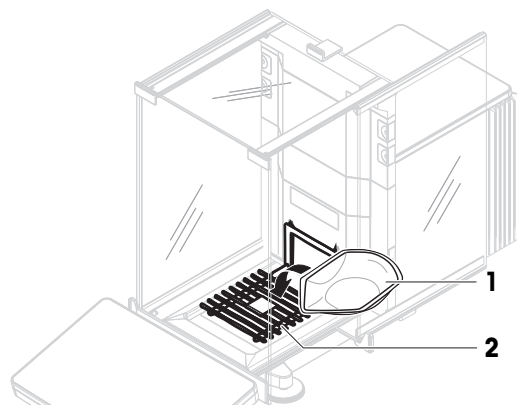

- 1 Open the draft shield.
  - 2 Clear the weighing pan.
  - 3 Close the draft shield.
  - 4 Press  $\rightarrow 0 \leftarrow$  to zero the balance.
  - 5 Open the draft shield.
  - 6 Place the sample vessel (1) on the weighing pan (2).
  - 7 Close the draft shield.
  - 8 Press  $\rightarrow T \leftarrow$  to tare the balance.
- ➔ The balance is tared. The icon <sup>Net</sup> appears.



### 4.6.4 Performing a weighing

- 1 Open the draft shield.
  - 2 Place the weighing object into the sample vessel.
  - 3 Close the draft shield.
  - 4 Tap  $\oplus$  **Add result** if you want to report the weighing result.
- ➔ The result is added to the **Results list**.

## 4.6.5 Completing the weighing

- 1 To save the **Results list**, tap  **Complete**.
  - ➔ The window **Complete task** opens.
- 2 Select an option to save or print the **Results list**.
  - ➔ The respective dialog opens.
- 3 Follow the instructions from the wizard.
- 4 Tap  **Complete**.
  - ➔ The **Results list** is saved/printed and then cleared.

## 4.7 Transporting, packing and storing

### 4.7.1 Transporting the balance over short distances



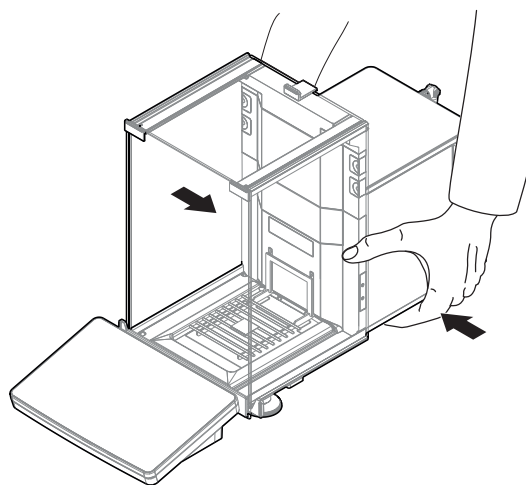

- 1 Disconnect the AC/DC adapter and unplug all interface cables.
- 2 Hold the platform with both hands and carry the balance in horizontal position to the target location. Consider the requirements of the location.

If you want put the balance into operation, proceed as follows:

- 1 Connect in reverse order.
- 2 Level the balance.
- 3 Perform an internal adjustment.



#### See also

-  [Selecting the location ▶ Page 26](#)
-  [Switching on the balance ▶ Page 32](#)
-  [Leveling the balance ▶ Page 33](#)
-  [Performing an internal adjustment ▶ Page 33](#)

### 4.7.2 Transporting the balance over long distances

METTLER TOLEDO recommends using the original packaging for transportation or shipment of the balance or balance components over long distances. The elements of the original packaging are developed specifically for the balance and its components and ensure maximum protection during transportation.

#### See also

-  [Unpacking the balance ▶ Page 26](#)

### 4.7.3 Packing and storing

#### Packing the balance

Store all parts of packaging in a safe place. The elements of the original packaging are developed specifically for the balance and its components, and ensures maximum protection during transportation and storage.

#### Storing the balance

Only store the balance under the following conditions:

- Indoor and in the original packaging

- According to the environmental conditions, see "Technical Data"

**Note**

When storing for longer than 6 months, the rechargeable battery may become empty (only date and time get lost).

**See also**

[Technical Data](#) ▶ Page 225

## 4.8 Weighing below the balance

Your balance is equipped with a weighing hook for performing weighing operations below the work surface (weighing below the balance).

- A weighing table or workbench is available, through which the weighing hook can be accessed.
- 1 Disconnect the balance from the AC/DC adapter.
  - 2 Disconnect all interface cables.
  - 3 Carefully tilt the balance to its side.
  - 4 Loosen the screw (1) of the weighing hook cover (2).  
➔ The hook (3) is accessible.
  - 5 Rotate the cover 180°.
  - 6 Tighten the screw to secure the cover.
  - 7 Carefully put the balance back on its feet.
  - 8 Reconnect the AC/DC adapter and the interface cables.  
➔ The weighing hook is accessible and can be used for below-the-balance weighing.

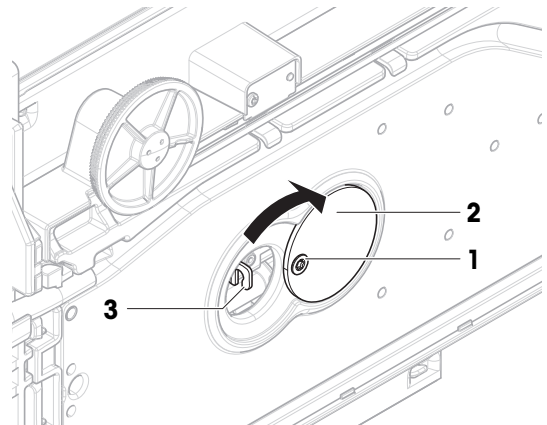

**See also**

[Dimensions](#) ▶ Page 232

## 5 Operation

### 5.1 Touch screen

#### 5.1.1 Selecting or activating an item

- Tap the item or function to be selected or activated.

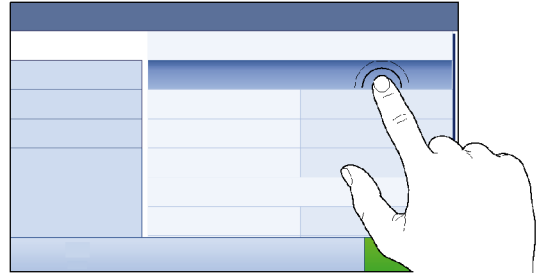

#### 5.1.2 Scrolling

- Move the list up/down.

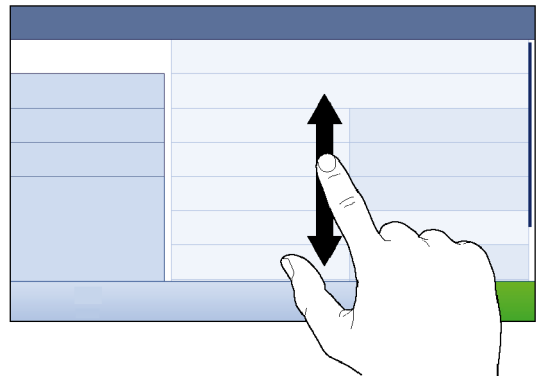

#### 5.1.3 Using the fly-in panels

Three fly-in panels are placed along the sides of the main weighing screen.

- 1 Place the finger on one tab along one side of the screen, e.g., ◀.

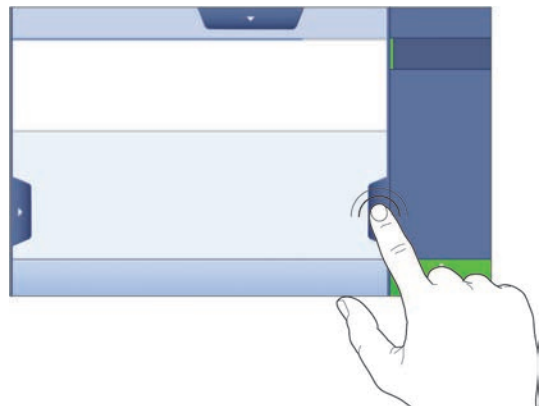

- Keep the finger on the tab and slide it in the direction towards which the arrow is pointing.

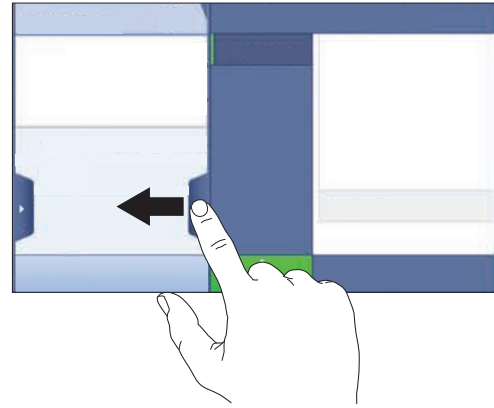

**Note**

The fly-in panels can also be opened or closed by tapping the associated tab.

### 5.1.4 Entering characters and numbers



	Name	Description
1	Input field	Shows the data that has been entered.
2	Backspace	Deletes the character left of the current cursor position. The cursor can be positioned by using the touch screen.
3	Discard	Closes the keyboard dialog.
4	Confirm	Confirms the entered data.
5	Numbers and special characters	Switches into the special character mode.
6	Shift	Switches between lower or upper case letters.
7	Menu section title	Shows the title of the current setting section.

### 5.1.5 Changing the date and time

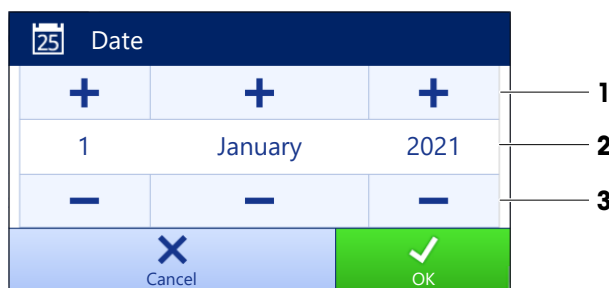



	Name	Explanation
1	Plus button	Increment
2	Display field	Shows the defined time or date.
3	Minus button	Decrement

### Note

The format of date and time can be defined in the settings via the options **Date format** and **Time format**.

### See also

 [Date / Time / Language / Format](#) ▶ Page 117

## 5.2 Methods

A weighing method is an application for carrying out specific weighing tasks. The balance offers the method "General Weighing" with default parameters. You have the possibility to create a maximum of 50 methods and edit the methods. You can use these methods for your weighing task or edit them according to your requirements. Methods can also be deleted or cloned.









To support you while configuring new methods, a configuration wizard leads you through the whole process. The changes performed to a method are recorded in the change history (if activated).

### 5.2.1 Methods overview

The section **Methods list** provides an overview of all methods already created on the balance. In this section, new methods can be defined and existing methods can be edited, cloned or deleted. It is also the starting point for using any method in a weighing procedure.

 **Navigation:** ▼ **Methods** >  **Methods list**

The following methods are available:

-  **General weighing** (see [Method "General weighing" ▶ Page 39])
-  **Simple formulation** (see [Method "Simple formulation" ▶ Page 41])
-  **Interval weighing** (see [Method "Interval weighing" ▶ Page 43])
-  **Titration** (see [Method "Titration" ▶ Page 44])
-  **Density determination** (see [Method "Density determination" ▶ Page 45])
-  **SQC** (see [Method "SQC" ▶ Page 47])
-  **Piece Counting** (see [Method "Piece Counting" ▶ Page 51])
-  **Automated dosing** (see [Method "Automated dosing" ▶ Page 53])
-  **Automated solution prep.** (see [Method "Automated solution prep." ▶ Page 58])

### 5.2.2 Method "General weighing"

The method **General weighing** offers the basic weighing functions (zeroing, taring, weighing). The method is used for simple weighing tasks or to perform a series of check weighing or dosing.

The settings of the weighing item, e.g., target weight and tolerances, can be specified for one or multiple weighing items. Two different methods exist:

- **General weighing:**
  - Select this method if you want to work with a single set of parameters.
- **General weighing (itemized):**
  - Select this method if you want to define the parameters for multiple weighing items. A method with multiple weighing items is particularly useful when the weighing task consists of a series of weighings, each with its own individual parameters, such as target weight, tolerances, etc. For further information, see [Using methods with multiple weighing items (itemized) ▶ Page 64].



You have the possibility to start with method factory setting parameter or to create a new method with changed method parameter.

For details about method settings:

#### See also

- 🔗 Settings: method "General weighing" ▶ Page 125
- 🔗 Using methods with multiple weighing items (itemized) ▶ Page 64

### 5.2.2.1 Creating a method "General weighing"

≡ Navigation: ▼ **Methods** > ≡] **Methods list**

- 1 Tap **+ New** in the action bar.
  - ➔ The method wizard opens, starting at **1. Method type**.
- 2 Tap **Method type** and select the method type **General weighing** or **General weighing (itemized)**.
- 3 Tap **→ Next**.
  - ➔ The method wizard opens the section **2. Identification**.
- 4 Define the **Method name** and **Result description** and tap **→ Next**.
  - ➔ The method wizard opens the section **3. Configuration**.
- 5 Select a **Tolerance profile** and tap **→ Next**.
  - ➔ The method wizard opens the section **4. Save**.
  - ➔ If setting up a method with multiple weighing items, the wizard opens the section **4. Weighing items**.
- 6 Select a weighing item from the list and define the **Sample ID**, **Unit**, **Target weight**, **-Tolerance**, and **+Tolerance**.
- 7 To add a weighing item, tap **+ Item** or **▣ Clone**.
- 8 Tap **→ Next**.
  - ➔ The method wizard opens the section **5. Save**.
- 9 Tap **✓ Finish** to save the new method.
  - ➔ The method has been created and appears in the list.

### 5.2.2.2 Performing a "General weighing"

This section describes a **General weighing** example step by step. Depending on the defined settings and weighing objects, the procedure can be different from this example.

- 1 Open the **Methods** section.
- 2 Select a method from the **Methods list** or define a new method.
- 3 Tap **▶ Start method**.
  - ➔ The main weighing screen appears with the selected method.
- 4 Press **→0←** to zero the balance.

- 5 Open the door and place the weighing object (1) on the weighing pan (2).
  - 6 Close the door and wait until the weight stabilizes.
    - ➔ The weighing starts with **Capturing weight...**
  - 7 Tap **+ Add result**.
    - ➔ The weighing result is saved to the **Results list**.
  - 8 When the weighing process is finished, tap  **Complete** in the action bar.
    - ➔ The window **Complete task** opens. The task-specific information can be printed on a label printer, the **Results list** can be printed manually or automatically (depending on the method settings), and the result can be exported to an external storage device.
- ➔ The task **General weighing** was successfully completed.

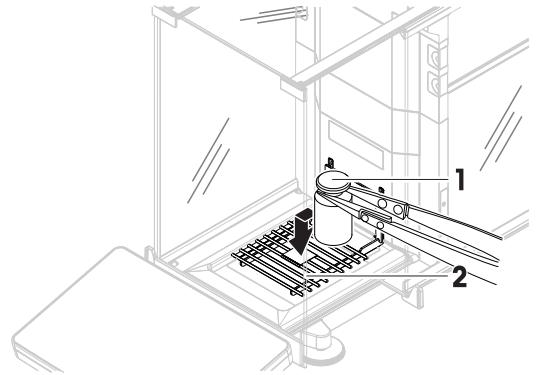

**Note**

It is possible to exclude a weighing result from the **Results list**. Open the **Results list**, select a result to exclude, and tap **Exclude result**.  
The window **Complete task** always appears after completing the task, even if the results are saved automatically.

### 5.2.3 Method "Simple formulation"

With the method **Simple formulation** the concentration of a substance can automatically be calculated.

The settings of the weighing item, e.g., target weight and tolerances, can be specified for one or multiple weighing items. Two different methods exist:



- **Simple formulation:**
  - Select this method if you want to weigh a single component in a volumetric flask and have the concentration calculated automatically.
- **Simple formulation (itemized):**
  - Select this method if you want to follow a predefined solution recipe of one or several components. A method with multiple weighing items is particularly useful when the weighing task consists of a series of weighings, each with its own individual parameters, such as target weight, tolerances, etc. For further information, see [Using methods with multiple weighing items (itemized) ▶ Page 64].

Methods		
 Methods list	 my general weighing	06/24/2022
 Manual operations	 my interval weighing	06/24/2022
 Tasks	 my simple formulation	06/24/2022
 Tests		
 Adjustments		

Delete
Clone
Edit
New
Print
▶ Start method

For details about method settings:

**See also**

-  Settings: method "Simple formulation" ▶ Page 136
-  Using methods with multiple weighing items (itemized) ▶ Page 64

### 5.2.3.1 Creating a method "Simple formulation"

☰ **Navigation:** ▼ **Methods** > ☰] **Methods list**

- 1 Tap **+** **New** in the action bar.
  - ➔ The method wizard opens, starting at **1. Method type**.
- 2 Tap **Method type** and select the method type **Simple formulation** or **Simple formulation (itemized)**.
- 3 Tap **→ Next**.
  - ➔ The method wizard opens the section **2. Identification**.
- 4 Define the **Method name** and **Result description** and tap **→ Next**.
  - ➔ The method wizard opens the section **3. Configuration**.
- 5 Select the options for **Calculate concentration per component**, **Calculate amount of component** and set a **Tolerance profile**.
- 6 Tap **→ Next**.
  - ➔ The method wizard opens the section **4. Save**.
  - ➔ When selected **Simple formulation (itemized)**, the wizard opens the optional creating section **4. Weighing items**.
- 7 Select a weighing item from the list and define the **Sample ID**, **Unit**, **Target weight**, **-Tolerance**, and **+Tolerance**.
  - ➔ The method wizard opens the section **5. Save**.
- 8 Tap **✓ Finish** to save the new method.
  - ➔ The method has been created and appears in the list.

### 5.2.3.2 Performing a "Simple formulation"

This example describes how to perform a **Simple formulation** with two components. It explains the basic functions of the method. Advanced functions such as the calculation of the concentration of a component can be defined in the method settings.

- 1 Open the **Methods** section.
- 2 Select a method from the **Methods list** or define a new method.
- 3 Tap **▶ Start method**.
  - ➔ The main weighing screen appears with the selected method.
- 4 Define the target weight and the tolerance limits for the first component.
- 5 Select **Component ID** to define the first component.
- 6 Select **Task ID** to define the whole task.
- 7 Press **→0←** to zero the balance.
- 8 Open the door and place the sample vessel on the weighing pan.
- 9 Press **→T←** to tare the balance.
- 10 Open the door and add the first component in the sample vessel.
  - ➔ The measurement starts.
- 11 Tap **+** **Add result**.
  - ➔ The weighing result is saved to the **Results list**.
- 12 Define the target weight and the tolerance limits for the second component.
- 13 Select **Component ID** to define the second component.
- 14 Open the door and add the second component in the sample vessel.
- 15 Tap **+** **Add result**.
  - ➔ The weighing result is saved to the **Results list**.
- 16 Tap **☰ Complete** and select if you want to print or export the **Results list**.
  - ➔ The weight task is completed and the balance returns to the main weighing screen.

## 5.2.4 Method "Interval weighing"

With the method **Interval weighing**, the number of measurements and the time interval for each measurement can be defined.



For details about method settings:

### See also

[Settings: method "Interval weighing" ▶ Page 146](#)

### 5.2.4.1 Creating a method "Interval weighing"

Navigation: ▼ **Methods** > ☰ **Methods list**

- 1 Tap **+** **New** in the action bar.
  - ➔ The method wizard opens, starting at **1. Method type**.
- 2 Tap **Method type** and select the method type **Interval weighing**.
- 3 Tap **→ Next**.
  - ➔ The method wizard opens the section **2. Identification**.
- 4 Define the **Method name** and tap **→ Next**.
  - ➔ The method wizard opens the section **3. Configuration**.
- 5 Select a **Approximate interval**, the number of **Measurements**, select a **Tolerance profile** and tap **→ Next**.
  - ➔ The method wizard opens the section **4. Weighing item**.
- 6 Select a **Unit** for the weighing and tap **→ Next**.
  - ➔ The method wizard opens the section **5. Save**.
- 7 Tap **✓ Finish** to save the new method.
  - ➔ The method has been created and appears in the list.

### 5.2.4.2 Performing an "Interval weighing"

This section describes how the method **Interval weighing** is being used in a task example. In this example we are weighing one single weight with a tare container.

- 1 Open the **Methods** section.
- 2 Select a method from the **Methods list** or define a new method.
- 3 Tap **▶ Start method**.
  - ➔ The main weighing screen appears with the selected method.
- 4 Press **→0←** to zero the balance.
- 5 Open the door.
- 6 If a container is used, place the container on the weighing pan.
- 7 Press **→T←** to tare the balance.

- ➔ The door closes automatically (depending on the door settings)
  - ➔ The tare-measurement starts with **Taring...**
  - ➔ When taring is finished, the door opens automatically (depending on the door settings).
- 8 Place the weighing object into the sample vessel.
  - 9 Close the door.
  - 10 Tap ► **Start**.
    - ➔ The defined method is being executed. The **Results list** shows the current counter.
  - 11 Wait until the process is finished.
    - ➔ The **Results list** opens and shows a summary of the weighing results.
  - 12 Tap  **Complete** to open the export options.
    - ➔ The dialog **Complete task** appears.
  - 13 Tap **Export results manually** to export the weighing results to an external USB storage device or tap ✓ **Complete** to finish the task.
    - ➔ After completing the task, the results are deleted from the **Results list**.

 **Note**

The current weighing process can be stopped by tapping  **Stop**.

## 5.2.5 Method "Titration"

The method **Titration** enables the interaction between the balance and the titrator via MT-SICS or RFID tag. The optional RFID reader enables data to be read from and written to an RFID tag. The RFID tag serves as a data carrier between the balance and titrator. The RFID tag placed on the base of a titrating beaker easily and reliably transfers the sample data, e.g., sample ID and weight. For available RFID readers, see "Accessories".



For details about method settings:

**See also**

 Settings: method "Titration" ► Page 149

### 5.2.5.1 Creating a method "Titration"

≡ **Navigation:** ▼ **Methods** >  **Methods list**

- 1 Tap **+ New** in the action bar.
  - ➔ The method wizard opens, starting at **1. Method type**.
- 2 Tap **Method type** and select the method type **Titration**.
- 3 Tap **→ Next**.
  - ➔ The method wizard opens the section **2. Identification**.
- 4 Define the **Method name** and **Result description** and tap **→ Next**.
  - ➔ The method wizard opens the section **3. Configuration**.

- 5 Select a **RFID option**, a **Tolerance profile** and tap → **Next**.
  - ➔ The method wizard opens the section **4. Save**.
- 6 Tap ✓ **Finish** to save the new method.
  - ➔ The method has been created and appears in the list.

**i Note**

The maximum text length of the **Sample ID** is 32 characters. If the RFID option activated, only the first 20 characters are transferred to the RFID tag.

### 5.2.5.2 Performing a "Titration"

This example describes how to prepare a sample for titration and to store the information on the RFID tag of the container using an external RFID reader such as the EasyScan USB. For more information about how to perform the titration, consult the manual of the titrator.

- An RFID tag is fixed under the weighing container.
  - The RFID reader is connected to the balance.
  - A titration method exists in the **Methods list** with the **RFID option** set to **Read and write**.
  - A METTLER TOLEDO titrator is connected to the balance via USB.
- 1 Open the **Methods** section.
  - 2 Select the desired titration method from the **Methods list**.
  - 3 Tap ► **Start method**.
    - ➔ The main weighing screen appears with the selected method.
    - ➔ The wizard indicates the steps to follow to perform the method.
  - 4 Place the container with RFID tag on the RFID reader.
    - ➔ The RFID reader reads the information from the RFID tag
    - ➔ The available data, if any, are included to the running task.
  - 5 If necessary, edit the sample information.
  - 6 Press →**0**← to zero the balance.
  - 7 Open the door and place the sample vessel on the weighing pan.
  - 8 Close the door and wait until the weight stabilizes.
  - 9 Press →**T**← to tare the balance.
  - 10 Open the door and place the sample in the sample vessel.
  - 11 Close the door and wait until the weight stabilizes.
  - 12 Tap ✓ **OK** to accept the measurement.
    - ➔ The result is automatically added to the **Results list**.
    - ➔ The weighing result is saved to the **Results list**.
  - 13 Take the container and place it on the RFID reader.
  - 14 Remove the sample vessel.
    - ➔ The task **Titration** gets completed automatically and the RFID-tag information is updated.
  - 15 Continue your workflow on the titrator.

### 5.2.6 Method "Density determination"

The method **Density determination** is used for determining the density of solids and liquids. Density determination is carried out based on **Archimedes' principle** according to which a body immersed in a fluid undergoes an apparent loss in weight that is equal to the weight of the fluid it displaces. On the other hand, the **Density determination** method also supports the pycnometer method, which does not rely on **Archimedes' principle**. The method **Density determination** includes three method types:

**Solid**: Determines the density of a solid with the help of a density kit.

**Liquid (sinker)**: Determines the density of a liquid with the help of a density kit and a sinker.

**Liquid (pycnometer):** Determines the density of a liquid in a glass vessel, for example, using a pycnometer.



For details about method settings:

### See also

[Settings: method "Density determination" ▶ Page 158](#)

## 5.2.6.1 Creating a method "Density determination"

≡ **Navigation:** ▼ **Methods** > ≡] **Methods list**

- 1 Tap **+** **New** in the action bar.
  - ➔ The method wizard opens, starting at **1. Method type**.
- 2 Tap **Method type** and select the method type **Density determination**.
- 3 Tap **→ Next**.
  - ➔ The method wizard opens the section **2. Identification**.
- 4 Define the **Method name** and **Result description** and tap **→ Next**.
  - ➔ The method wizard opens the section **3. Configuration**.
- 5 Select the **Determination type** and define the corresponding settings, e.g., **Density unit** and **Weighing settings**.
- 6 Tap **→ Next**.
  - ➔ The method wizard opens the section **4. Weighing item**.
- 7 Define **Initial values for weighing** and tap **→ Next**.
  - ➔ The method wizard opens the section **5. Save**.
- 8 Tap **✓ Finish** to save the new method.
  - ➔ The method has been created and appears in the list.

### **i** Note

The **Determination type** can only be selected as part of a new created method. If another **Determination type** (solid, liquid) is required, a new method must be created.

## 5.2.6.2 Performing a "Density determination"

This example describes how to determine the density of a solid using a density kit.

- A density kit is available for the balance.
- 1 Open the **Methods** section.
  - 2 Select a method from the **Methods list** or define a new method.
  - 3 Tap **▶ Start method**.
    - ➔ The main weighing screen appears with the selected method.
  - 4 Tap **▶ Start**.



- 5 Specify the **Temperature** and the **Aux. liquid**.
- 6 Tap **✓ OK**.
- 7 Follow the instructions from the wizard.
  - Note**
  - For approved balances, if the zeroing fails, use the function **Perform initial zero**, see [Service menu ▶ Page 124].
    - ➔ The **Results list** opens and shows a summary of the weighing results.
- 8 Tap **🖨 Complete** to open the printing options.
  - ➔ The dialog **Complete task** appears.
- 9 Tap **✓ Complete**.
  - ➔ The task **Density determination** was successfully completed.

## 5.2.7 Method "SQC"

The method **SQC** (statistical quality control) is used to gather statistical data about samples to, ultimately, control their quality. This method offers advanced statistical capabilities and can be highly automatized.

The **SQC** method requires a specific license in order to be available on your balance. Contact your METTLER TOLEDO sales representative to purchase the SQC license. After you get your personal license key, sign in to the Software Portal (▶ <https://activation.mt.com/>), and activate your license key. For more details, consult the instructions provided with your license key.



For details about method settings:

### See also

🔗 Settings: method "SQC" ▶ Page 165

### 5.2.7.1 Creating a method "SQC"

☰ **Navigation:** ▼ **Methods** > ☰ **Methods list**

- The SQC license key is activated for the balance.
- 1 Tap **+ New** in the action bar.
    - ➔ The method wizard opens, starting at **1. Method type**.
  - 2 Tap **Method type** and select the method type **SQC**.
  - 3 Tap **→ Next**.
    - ➔ The method wizard opens the section **2. Identification**.
  - 4 Define the **Method name**.
  - 5 Define **Number of task IDs** and their respective settings.
  - 6 Tap **→ Next**.
    - ➔ The method wizard opens the section **3. Configuration**.
  - 7 Select a **Tolerance profile**.

- 8 If using an automatic feeder LV12 for this method, activate the **Automatic feeder support** and specify the **Number of weighing items**, **Discharge feeder at the end**, and the **Feed rate**.
- 9 Tap **→ Next**.
  - ➔ The method wizard opens the section **4. Weighing item**.
- 10 If using a liquid of known density, the results on the weighing screen can be shown in units of volume. If desired, activate the setting **Liquid** and specify the **Liquid density**.
- 11 Specify the **Nominal** weight or volume of an individual weighing item. Alternatively, activate **Use measured average as nominal** and define a **Plausibility reference**.
- 12 Define the tolerance above (**+Tolerance T1**) and below (**-Tolerance T1**).
- 13 If using a second band of tolerances, activate **T2 tolerances** and define **+Tolerance T2** and **-Tolerance T2**.
  - ➔ The method wizard opens the section **5. Save**.
- 14 Tap **✓ Finish** to save the new method.
  - ➔ The method has been created and appears in the list.

### 5.2.7.2 Performing a "SQC" on packaged goods

The SQC method can be used on samples of a production line for packaged goods. This is illustrated here using the example of vials containing a medicinal solution. The specific settings that are appropriate to your application depend on your products, your industry, the regulations of your country, etc.

#### Setting up the method

- The SQC license key is activated for the balance.
  - A method **SQC** has been created.
- 1 Open the **Methods** section.
  - 2 Select a method **SQC** from the **Methods list**.
  - 3 Tap **✎ Edit**.

#### Editing ID format

- 1 Tap **ID format**.
- 2 Set the **Number of task IDs** to 2.
- 3 To use the **Task ID 1** to identify the batch ID, do not change its **Task description**.
- 4 To use the **Task ID 2** to identify the product number, edit its **Task description**. For example, type in "Product ID".

#### Editing Weighing

- 1 Tap **⚙ Weighing**.
- 2 Enable the option **Custom time span statistics 1**.
- 3 To gather statistics for a single batch, tap **Statistics 1 - Name** and type in "Single batch".
- 4 Leave the **Electrostatic** settings disabled to reduce the time required to weigh each item.

The time span of the custom statistics is controlled by the user. The label is given in the method as an indication to the user, but the statistics must be reset by the user manually when the time span has elapsed.

#### Editing Weighing item

- 1 Tap **🔧 Weighing item**.
- 2 Enable the option **Liquid**.
- 3 Specify the density of the liquid, for example 1 g/ml for water.
- 4 Enable **Calculate net weight excl. packaging**.
- 5 Specify the weight of the **Packaging**, in this case, a single empty vial.
- 6 Specify the **Nominal** volume of the liquid, e.g., 5 ml.
- 7 Set the **+Tolerance T1** and the **-Tolerance T1** to 7%.

- 8 Enable the **T2 tolerances**.
- 9 Set the **+Tolerance T2** and the **-Tolerance T2** to 14%.







### Editing Automation

- 1 Tap  **Automation**.
- 2 Enable **Automatic zero** and leave **Automatic zero threshold** to its default value.
- 3 Set **Automatic result** to **Without sample tare**. Leave **Automatic result threshold** to its default value and **Weight trigger** to **Exceeding**.

### Editing Print / Export

- 1 Keep the default **Print / Export** settings.
- 2 Tap  **Save**.

### Running the method

- 1 Select the method from the **Methods list**.
- 2 Tap  **Start method**.
  - ➔ The main weighing screen appears with the selected method.
- 3 Fill in the user-specific task IDs: "Batch ID" and "Product ID".
- 4 Press  **0**  to zero the balance.
- 5 Add one item on the weighing pan. In this example, that is one filled vial.
  - ➔ As soon as the weight is stable, the result is automatically added to the **Results list**.
  - ➔ For each individual result, the status indicator shows the status of the result: **OK**, **Not OK**, or **Excluded**.
  - ➔ If the result is within the **Plausibility limits**, the value is added to the statistics.
- 6 Remove the item from the weighing pan.
  - ➔ The balance starts an automatic zeroing.
- 7 Repeat until the desired number of items is reached.
- 8 Tap  **Complete** to open the printing options.
  - ➔ The dialog **Complete task** appears.
- 9 Print or export the results if needed.
- 10 Tap  **Complete**.
  - ➔ The individual results are deleted from the **Results list**, but are still included in the time span statistics.
- 11 To print the time span statistics, select the statistics in the **Results list** and tap  **Print**.

### Resetting the statistics

When the time span of the custom statistics has elapsed, the user needs to reset the statistics manually.

- 1 Open the **Results list**.
- 2 Tap the time span statistics that you want to reset.
- 3 Tap  **Reset**.

#### 5.2.7.3 Performing a "SQC" with automatic feeder

In this particular example, the SQC method is used to test medical pills. The pills are dispensed one by one on the weighing pan by the automatic feeder LV12. The specific settings that are appropriate to your application depend on your products, your industry, the regulations of your country, etc.

## Setting up the method

- The SQC license key is activated for the balance.
  - A method **SQC** has been created.
  - An automatic feeder LV12 is installed on the balance.
  - The door automation is switched off on the side where the automatic feeder LV12 is installed.
  - Optionally, the LV12 door is installed on the side where the automatic feeder LV12 is installed.
- 1 Open the **Methods** section.
  - 2 Select a method **SQC** from the **Methods list**.
  - 3 Tap  **Edit**.

## Editing ID format

- 1 Tap  **ID format**.
- 2 Set the **Number of task IDs** to 3.
- 3 To use the **Task ID 1** to identify the batch ID, do not change its **Task description**.
- 4 To use the **Task ID 2** to identify the product number, edit its **Task description**. For example, type in "Product ID".
- 5 To use the **Task ID 3** to identify the production line, edit its **Task description**. For example, type in "Production line".

## Editing Weighing

- 1 Tap  **Weighing**.
- 2 Enable the option **Custom time span statistics 1**.
- 3 To gather daily statistics, tap **Statistics 1 - Name** and type in "Daily".
- 4 Enable the option **Custom time span statistics 2**.
- 5 To gather weekly statistics, tap **Statistics 2 - Name** and type in "Weekly".
- 6 Leave the **Electrostatic** settings disabled to reduce the time required to weigh each item.

The time span of the custom statistics is controlled by the user. The label is given in the method as an indication to the user, but the statistics must be reset by the user manually when the time span has elapsed.

## Editing Weighing item

- 1 Tap  **Weighing item**.
- 2 Enable **Use measured average as nominal**.
- 3 Set the **Plausibility reference** to the approximate weight of a single pill, e.g., 280 mg.
- 4 Set the **Plausibility limits** to 20% .
- 5 Set the **+Tolerance T1** and the **-Tolerance T1** to 5%.
- 6 Enable the **T2 tolerances**.
- 7 Set the **+Tolerance T2** and the **-Tolerance T2** to 10%.



## Editing Automation

- 1 Tap  **Automation**.
- 2 If not already done while creating the method, enable the **Automatic feeder support**.
- 3 Set the **Number of weighing items** to 20.
- 4 Set the **Tare Mode** to **Automatic tare**.

## Editing Print / Export

- 1 Keep the default **Print / Export** settings.
- 2 Tap  **Save**.

## Running the method

- 1 Select the method from the **Methods list**.
- 2 Tap ► **Start method**.
  - ➔ The main weighing screen appears with the selected method.
- 3 Fill in the user-specific task IDs: "Batch ID", "Product name", and "Production line".
- 4 Press →0← to zero the balance.
- 5 Place a sample vessel on the weighing pan, big enough to collect all the pills that will be dispensed by the automatic feeder. Make sure that there is no contact between the sample vessel and the automatic feeder.
- 6 Tap  ► **Start** to start the weighing process.
  - ➔ Due to the method configuration, the balance tares automatically before it starts dispensing the pills.
  - ➔ The automatic feeder dispenses the pills one by one.
  - ➔ As soon as the weight is stable, the result is automatically added to the **Results list**.
  - ➔ For each individual result, the status indicator shows the status of the result: **OK**, **Not OK**, or **Excluded**.
  - ➔ If the result is within the **Plausibility limits**, the value is added to the statistics.
  - ➔ When the number of items passing the plausibility check is reached, the **Results list** opens.
- 7 Tap  **Complete** to open the printing options.
  - ➔ The dialog **Complete task** appears.
- 8 Print or export the results if needed.
- 9 Tap ✓ **Complete**.
  - ➔ The individual results are deleted from the **Results list**, but are still included in the time span statistics.
- 10 To print the time span statistics, select the statistics in the **Results list** and tap  **Print**.









## Resetting the statistics

When the time span of the custom statistics has elapsed, the user needs to reset the statistics manually.

- 1 Open the **Results list**.
- 2 Tap the time span statistics that you want to reset.
- 3 Tap ↻ **Reset**.

### 5.2.8 Method "Piece Counting"

The method **Piece Counting** allows you to determine the number of pieces put on the weighing pan. It is advantageous if all pieces are of approximately equal weight, since the unit quantity is determined on the basis of the average weight of a single piece.

Methods		
 Methods list	 my general weighing	06/24/2022
 Manual operations	 my piece counting	06/24/2022
 Tasks		
 Tests		
 Adjustments		
 Delete	 Clone	 Edit
 New	 Print	 Start method

For details about method settings:

#### See also

 Settings: method "Piece Counting" ► Page 173

### 5.2.8.1 Creating a method "Piece Counting"

☰ **Navigation:** ▼ **Methods** > ☰ **Methods list**

- 1 Tap **+** **New** in the action bar.
  - ➔ The method wizard opens, starting at **1. Method type**.
- 2 Tap **Method type** and select the method type **Piece Counting**.
- 3 Tap **→ Next**.
  - ➔ The method wizard opens the section **2. Identification**.
- 4 Define the **Method name** and **Result description** and tap **→ Next**.
  - ➔ The method wizard opens the section **3. Configuration**.
- 5 Select a **Tolerance profile** and tap **→ Next**.
  - ➔ The method wizard opens the section **4. Weighing item**.
- 6 Define a reference for pieces **Reference PCS**, a **Reference average weight**, **Target weight** and tap **→ Next**.
  - ➔ The method wizard opens the section **5. Save**.
- 7 Tap **✓ Finish** to save the new method.
  - ➔ The method has been created and appears in the list.

### 5.2.8.2 Performing a "Piece Counting"

This section describes how the method **Piece Counting** is being used in a task example. In this example we are weighing pieces in a sample vessel.

- 1 Open the **Methods** section.
- 2 Select a method from the **Methods list** or define a new method.
- 3 Tap **▶ Start method**.
  - ➔ The main weighing screen with the selected method opens. The balance displays the defined target value, the tolerance and the current average weight of one piece.
- 4 Press **→0←** to zero the balance.  
or  
If a container is used, place the container (1) on the weighing pan (2) and press **→T←** to tare the balance.
  - ➔ The door closes automatically (depending on the door settings)
  - ➔ The tare-measurement starts with **Taring...**
  - ➔ When taring is finished, the door opens automatically (depending on the door settings).
- 5 If not yet done, enter the average weight for a known number of pieces in the method settings. This serves as reference for the piece counting. Tap **📊** to capture the weight of the items on the weighing pan and use it as reference weight.

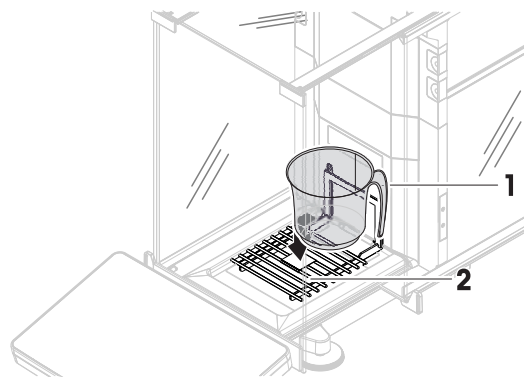

- 6 Place the pieces in the sample vessel.
  - 7 Close the door and wait until the weight stabilizes.
  - 8 Tap **+ Add result**.
    - ➔ The weighing result is saved to the **Results list**.
  - 9 When the weighing process is finished, tap  **Complete** in the action bar.
    - ➔ The window **Complete task** opens. The task-specific information can be printed on a label printer, the **Results list** can be printed manually or automatically (depending on the method settings), and the result can be exported to an external storage device.
- ➔ The task **Piece Counting** was successfully completed.

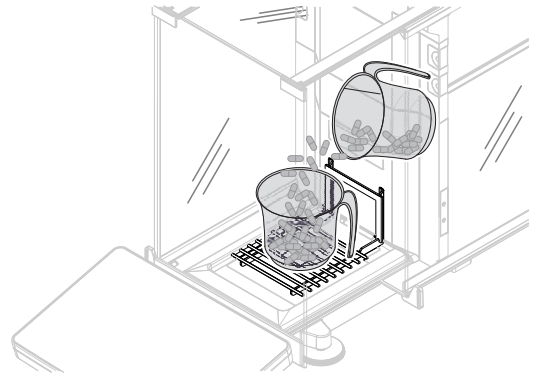

 **Note**

It is possible to exclude a weighing result from the **Results list**. Open the **Results list**, select a result to exclude, and tap **Exclude result**.  
The window **Complete task** always appears after completing the task, even if the results are saved automatically.

### 5.2.9 Method "Automated dosing"

The operations described in this section are only available for automatic balances. Automatic operations related to dosing are performed using one or several of the following products:

- Q3 dosing module
- QLX3 liquid module
- QS3 sample changer

 **Note**

Although methods of type **Automated dosing** and **Automated solution prep.** can only be performed on automatic balances, they can be created and edited on any XPR analytical balance and later copied on your automatic balance.

The methods **Automated dosing** and **Automated dosing (itemized)** are used to automatically dose a predefined amount of a powder or liquid.

The settings of the weighing item, e.g., target weight and tolerances, can be specified for one or multiple weighing items. Two different methods exist:

- **Automated dosing:**
  - Select this method if you want to work with a single set of parameters.
- **Automated dosing (itemized):**
  - Select this method if you want to define the parameters for multiple weighing items. A method with multiple weighing items is particularly useful when the weighing task consists of a series of weighings, each with its own individual parameters, such as target weight, tolerances, etc. For further information, see [Using methods with multiple weighing items (itemized) ▶ Page 64].

Methods		
 Methods list	 my general weighing	06/24/2022
 Manual operations	 my interval weighing	06/24/2022
 Tasks	 my automated dosing	06/24/2022
 Tests		
 Adjustments		
 Delete  Clone  Edit  New  Print  Start method		

For details about method settings:

#### See also

 Settings: method "Automated dosing" ▶ Page 182

### 5.2.9.1 Creating a method "Automated dosing"

☰ **Navigation:** ▼ **Methods** > ☰] **Methods list**

- A Q3 dosing module or QLX3 liquid module is installed on the balance.
  - If you are dosing a liquid, make sure that a **Tolerance profile** is available with a maximum of four digits. If using a balance with a readability of six digits, set the **Value release** to **Fast** or **Very fast**. To create a new **Tolerance profile**, see [Tolerance profiles ▶ Page 94].
- 1 Tap **+ New** in the action bar.
    - ➔ The method wizard opens, starting at **1. Method type**.
  - 2 Tap **Method type** and select the method type **Automated dosing** or **Automated dosing (itemized)**.
  - 3 Tap **→ Next**.
    - ➔ The method wizard opens the section **2. Identification**.
  - 4 Define the **Method name** and **Result description** and tap **→ Next**.
    - ➔ The method wizard opens the section **3. Configuration**.
  - 5 Select a **Tolerance profile** and/or a **Tolerance profile (liquid)**. Tap **→ Next**.
    - ➔ The method wizard opens the section **4. Save**.
    - ➔ If setting up a method with multiple weighing items, the wizard opens the section **4. Weighing items**.
  - 6 Select a weighing item from the list and define the **Sample ID**, **Unit**, **Target weight**, **-Tolerance**, and **+Tolerance**. The **Substance** can be typed in manually or copied from the attached dosing head by tapping .
  - 7 To add a weighing item, tap **+ Item** or **■ Clone**.
  - 8 Tap **→ Next**.
    - ➔ The method wizard opens the section **5. Save**.
  - 9 Tap **✓ Finish** to save the new method.
    - ➔ The method has been created and appears in the list.

#### See also

 Tolerance profiles ▶ Page 94

### 5.2.9.2 Performing an "Automated dosing" with the Q3 dosing module



This section describes how a method **Automated dosing** can be used to dose powder into a sample vessel with the Q3 dosing module. This example uses the optical sensor of the Q3 dosing module and applies a user-defined height adjustment to set up the height of the dosing head.



## Setting up the method

- A Q3 dosing module is installed on the balance.
  - A powder dosing head is attached to the dosing module.
  - A method **Automated dosing** has been created.
- 1 Open the **Methods** section.
  - 2 Select a method **Automated dosing** from the **Methods list**.
  - 3 Tap  **Edit**.

## Editing Dosing

- A sample vessel (typically, with adaptor and chosen ErgoClip) is placed on the weighing pan. The opening of the vessel is aligned with the tip of the dosing head. The opening of the vessel is more than 75 mm above the weighing pan.
- 1 Tap  **Dosing**.
  - 2 Check that **HeightDetect** is set to **Active**.
  - 3 Set **Allow fine adjustment** to **Active**.
  - 4 Tap  **Fine adjustment** in the action bar and follow the instructions from the wizard.
    - ➔ The **Fine adjustment** is saved to the method settings and will be used each time the method is run.

For more information about the height of the dosing head, see [Setting the height of the dosing head ▶ Page 97].



## Editing ID format

- 1 Tap  **ID format**.
- 2 Keep the default settings.

## Editing Weighing

- 1 Tap  **Weighing**.
- 2 Keep the default settings.

## Editing Weighing item

- 1 Tap  **Weighing item**.
- 2 Import the name of the substance from the dosing head data by tapping .
- 3 Set the **Target weight** to 5 mg with the **-Tolerance** and **+Tolerance** to 10%.



## Editing Automation



- 1 Tap  **Automation**.
- 2 Keep the default settings.

## Editing Print / Export





- 1 Keep the default **Print / Export** settings.
- 2 Tap  **Save**.

## Editing the dosing head data

- A powder dosing head is attached to the dosing module.
- 1 Select the method from the **Methods list**.
  - 2 Tap  **Start method**.
    - ➔ The main weighing screen appears with the selected method.
  - 3 On the weighing screen, tap  to display all the data written on the RFID tag of the dosing head.
  - 4 Tap  **Edit** to edit the data of the attached dosing head.

- 5 If the powder to be dosed needs to be shaken in the dosing head before or during dosing, set **Tapping before dosing** or **Tapping while dosing** to **Active**.
- 6 Edit any other field, if needed.
  -  **Note**  
The name of the substance on the dosing head must correspond to the name of the substance used as setting in the method, if specified.
- 7 Tap  **OK** to save the data.

### Running the method

- The method has been started.
- 1 Fill in the **Sample ID**.
  - 2 Remove the sample vessel from the weighing pan. If you are using an ErgoClip, leave it installed with the adapter (if applicable).
  - 3 Close the draft shield.
  - 4 Press  **0**  to zero the balance.
  - 5 Place the sample vessel on the weighing pan or on the ErgoClip/adapter.
  - 6 Close the draft shield.
  - 7 Tap  **Start**.
    - ➔ The balance is taring.
    - ➔ The dosing head moves to **Dosing position**.
    - ➔ The substance is dosed.
    - ➔ The dosing head moves to **Safe position**.
    - ➔ The weighing result is captured.
    - ➔ The result is automatically added to the **Results list**.
  - 8 Tap  **Complete** to open the printing options.
    - ➔ The dialog **Complete task** appears.
  - 9 Print or export the results if needed.
  - 10 Tap  **Complete**.
    - ➔ After completing the task, the results are deleted from the **Results list**.
    - ➔ The dosing head moves to **Home position**.

### 5.2.9.3 Performing a series of dosings with the Q3 dosing module and QS3 sample changer

This section describes how the QS3 sample changer and the Q3 dosing module can be used to automatically fill multiple identical capsules with a defined amount of powder. This example uses a method **Automated dosing** with an absolute dosing height, typical for applications with sample vessels that all have the same height.

#### Setting up the method

- A Q3 dosing module is installed on the balance.
  - A QS3 sample changer is installed on the balance.
  - A powder dosing head is attached to the dosing module.
  - A method **Automated dosing** has been created.
- 1 Open the **Methods** section.
  - 2 Select a method **Automated dosing** from the **Methods list**.
  - 3 Tap  **Edit**.

#### Editing Dosing

- 1 Tap  **Dosing**.
- 2 Set **HeightDetect** to **Inactive**.

- 3 Set **Safe position** to **Active**.
- 4 Specify the **Number of samples**, for example, 30.

For more information about the height of the dosing head, see [Setting the height of the dosing head ▶ Page 97].



### Editing ID format

- 1 Tap  **ID format**.
- 2 Set the **Result ID 1** to **Automatic counter**.
- 3 Set the **Prefix** to "Sample".
  - ➔ Each sample will be assigned a name of the form "Sample 1", "Sample 2", etc.

### Editing Weighing

- 1 Tap  **Weighing**.
- 2 Enable **Activate statistics**.

### Editing Weighing item

- 1 Tap  **Weighing item**.
- 2 Import the name of the substance from the dosing head data by tapping .
- 3 Set the **Target weight** to 1 mg with the **-Tolerance** to 10% and **+Tolerance** to 20%.









### Editing Automation







- 1 Tap  **Automation**.
- 2 Keep the default settings.

### Editing Print / Export

- 1 Keep the default **Print / Export** settings.
- 2 Tap  **Save**.

### Running the method

- A powder dosing head is attached to the dosing module.
  - All sample vessels and adapters are installed on the sample changer.
  - The tunnel doors are closed.
- 1 Select the method from the **Methods list**.
  - 2 Tap  **Start method**.
    - ➔ The main weighing screen appears with the selected method.
  - 3 Tap  **Sample Changer**.
  - 4 Tap the arrows until a sample changer position containing a vial is on top of the weighing pan.
  - 5 Tap  **Set position** and follow the instructions from the wizard.
  - 6 Tap  **Sample Changer**.
    - ➔ The **Dosing position** is saved for this task, but not saved to the method settings.
  - 7 Tap  **Home position** to bring the **Home position** on top of the weighing pan.
  - 8 Press  **0**  to zero the balance.
  - 9 Tap  **Start** to start the weighing process.
    - ➔ The dosing head moves to **Safe position**.
    - ➔ The balance is taring.
    - ➔ The dosing head moves to **Dosing position**.
    - ➔ The substance is dosed.
    - ➔ The dosing head moves to **Safe position**.
    - ➔ The weighing result is captured.

- ➔ The result is automatically added to the **Results list**.
  - ➔ The sample changer moves to the next sample vessel. If a position on the sample changer is empty (without a vessel and without an adapter), the position is skipped.
  - ➔ The dosing process is repeated until the **Number of samples** is reached.
  - ➔ After the last sample is dosed, a window opens, showing in red all positions that have a weighing result with status **Not OK**.
- 10 Tap  **Complete**.
- ➔ The **Results list** opens and shows a summary of the weighing results.
- 11 Tap on a sample to show the details.
- 12 To exclude the selected sample, tap  **Exclude result**.
- 13 To take out the chosen sample from the sample changer, tap  **Take out item** (or  **Take out item**, if the **Loading / unloading** setting of the sample changer was set to **Left side**), see [Modules / Dosing ▶ Page 119].
- ➔ The sample changer moves the chosen sample to the unloading area.
- 14 Open the tunnel to take out the sample.
- 15 Tap  **Complete** to open the printing options.
- ➔ The dialog **Complete task** appears.
- 16 Print or export the results if needed.
- 17 Tap  **Complete**.
- ➔ The dosing head moves to **Home position**.
  - ➔ After completing the task, the results are deleted from the **Results list**.

## 5.2.10 Method "Automated solution prep."

The operations described in this section are only available for automatic balances. Automatic operations related to dosing are performed using one or several of the following products:

- Q3 dosing module
- QLX3 liquid module
- QS3 sample changer

### **Note**

Although methods of type **Automated dosing** and **Automated solution prep.** can only be performed on automatic balances, they can be created and edited on any XPR analytical balance and later copied on your automatic balance.

The methods **Automated solution prep.** and **Automated solution prep. (itemized)** are used to prepare a solution where at least one of the components is dosed automatically. When using **Dissolve**, a solute is dissolved in a solvent. When using **Dilute solution**, solvent is added to a solution to dilute its concentration.

The settings of the weighing item, e.g., target weight and tolerances, can be specified for one or multiple weighing items. Two different methods exist:

- **Automated solution prep.:**
  - Select this method if you want to work with a single set of parameters.
- **Automated solution prep. (itemized):**
  - Select this method if you want to define the parameters for multiple weighing items. A method with multiple weighing items is particularly useful when the weighing task consists of a series of weighings, each with its own individual parameters, such as target weight, tolerances, etc. For further information, see [Using methods with multiple weighing items (itemized) ▶ Page 64].

Methods	
Methods list	my general weighing 06/24/2022
Manual operations	my interval weighing 06/24/2022
Tasks	my automated solution 06/24/2022
Tests	
Adjustments	

Delete   Clone   Edit   New   Print   Start method

For details about method settings:

### See also

Settings: method "Automated solution prep." ▶ Page 190

## 5.2.10.1 Creating a method "Automated solution prep."

Navigation: ▼ **Methods** > ☰ **Methods list**

- A Q3 dosing module or QLX3 liquid module is installed on the balance.
  - If you are dosing a liquid, make sure that a **Tolerance profile** is available with a maximum of four digits. If using a balance with a readability of six digits, set the **Value release** to **Fast** or **Very fast**. To create a new **Tolerance profile**, see [Tolerance profiles ▶ Page 94].
- 1 Tap **+ New** in the action bar.
    - ➔ The method wizard opens, starting at **1. Method type**.
  - 2 Tap **Method type** and select the method type **Automated solution prep.** or **Automated solution prep. (itemized)**.
  - 3 Tap **→ Next**.
    - ➔ The method wizard opens the section **2. Identification**.
  - 4 Define the **Method name** and **Result description** and tap **→ Next**.
    - ➔ The method wizard opens the section **3. Configuration**.
  - 5 Select a **Tolerance profile** and/or a **Tolerance profile (liquid)**. Tap **→ Next**.
    - ➔ The method wizard opens the section **4. Save**.
    - ➔ If setting up a method with multiple weighing items, the wizard opens the section **4. Weighing items**.
  - 6 Select a weighing item from the list and define the **Component 1** and **Component 2**. The **Substance** can be typed in manually or copied from the attached dosing head by tapping .
  - 7 To add a weighing item, tap **+ Item** or **Clone**.
  - 8 Tap **→ Next**.
    - ➔ The method wizard opens the section **5. Save**.
  - 9 Tap **✓ Finish** to save the new method.
    - ➔ The method has been created and appears in the list.



## 5.2.10.2 Performing a solution preparation (dissolve) with the Q3 dosing module

This section presents an example where a solution is prepared by dissolving a powder in a solvent. Both the powder and the liquid are dosed with the Q3 dosing module. The target concentration and the total weight of the solution are specified in the method settings; the weight of both components is calculated automatically by the wizard. For this use case, the height of the dosing head is adjusted without the optical detection.

## Setting up the method

- A Q3 dosing module is installed on the balance.
  - A powder dosing head is attached to the dosing module.
  - A method **Automated solution prep.** has been created.
- 1 Open the **Methods** section.
  - 2 Select a method **Automated solution prep.** from the **Methods list**.
  - 3 Tap  **Edit**.

## Editing Solution

- A sample vessel (typically, with adaptor and chosen ErgoClip) is placed on the weighing pan. The opening of the vessel is aligned with the tip of the dosing head.
- 1 Tap  **Solution**.
  - 2 Set **HeightDetect** to **Inactive**.
  - 3 Set **Safe position** to **Active**.
  - 4 Tap  **Set position** and follow the instructions from the wizard.
    - ➔ The **Dosing position** is saved to the method settings and will be used each time the method is run.
  - 5 Set **Type** to **Dissolve**.
  - 6 Check that **Concentration unit** is set to **mg/g**.
  - 7 Set **Volumetric conc. unit** to **mg/ml**.
  - 8 Enable **Use density from dosing head**.
  - 9 Enable **Check for overflow**.
  - 10 Set **Production date** to **Current date**.
  - 11 Set **Expiry date** to **Period**, and set **Period** to 180 days.
  - 12 Check that **Weighing type** of **Component 1** is set to **Automated dosing**.
- For more information about the height of the dosing head, see [Setting the height of the dosing head ► Page 97].



## Editing ID format

- 1 Tap  **ID format**.
- 2 Keep the default settings.

## Editing Weighing

- 1 Tap  **Weighing**.
- 2 Make sure that the selected **Tolerance profile (liquid)** uses a maximum of four digits. If using a balance with a readability of six digits, the **Value release** must be set to **Fast** or **Very fast**.

## Editing Weighing item

- 1 Tap  **Weighing item**.
- 2 Set **Target concentration** to, for example, 1 mg/g.
- 3 Set **Target weight** to, for example, 10 g.
- 4 Import the name of the substance for **Component 1** from the dosing head data by tapping .
- 5 Note that the **Target weight** of **Component 1** is a read-only field. It is calculated based on the target parameters of the solution.
- 6 Set the **-Tolerance** and **+Tolerance** to 5%.
- 7 Type in the name of the substance of **Component 2** manually.

### **Note**

The name of the substance on the dosing head must correspond to the name of the substance used as setting in the method, if specified.



## Editing Automation







- 1 Tap  **Automation**.
- 2 Keep the default settings.

## Editing Print / Export

- 1 Keep the default **Print / Export** settings.
- 2 Tap  **Save**.

## Running the method

- A powder dosing head is attached to the dosing module.
  - A QL3 pump is connected to the balance.
  - A bottle with the required solvent and liquid dosing head is attached to the pump.
- 1 Select the method from the **Methods list**.
  - 2 Tap  **Start method**.
    - ➔ The main weighing screen appears with the selected method.
  - 3 To edit the parameters of the solution, tap . Save with  **OK**.

 **Note**  
Editing the settings of the solution through the weighing screen will apply to this task, but the changes will not be saved to the method itself.
  - 4 Tap  **OK**.
  - 5 Remove the sample vessel from the weighing pan. If you are using an ErgoClip, leave it installed with the adapter (if applicable).
  - 6 Close the draft shield.
  - 7 Press  **0**  to zero the balance.
  - 8 Place the sample vessel on the weighing pan or on the ErgoClip/adapter.
  - 9 Close the draft shield.
  - 10 Tap  **Start**.
    - ➔ The dosing head moves to **Safe position**.
    - ➔ The balance is taring.
    - ➔ The dosing head moves to **Dosing position**.
    - ➔ The substance is dosed.
    - ➔ The dosing head moves to **Safe position**.
    - ➔ The weighing result is captured.
    - ➔ The dosing head moves to **Home position**.
  - 11 Remove the powder dosing head from the Q3 dosing module and attach the liquid dosing head.
    - ➔ The dosing head moves to **Safe position**.
    - ➔ The balance is taring.
    - ➔ The dosing head moves to **Dosing position**.
    - ➔ The substance is dosed.
    - ➔ The dosing head moves to **Safe position**.
    - ➔ The weighing result is captured.
    - ➔ The dosing head moves to **Home position**.
  - 12 Tap  **Complete** to open the printing options.
    - ➔ The dialog **Complete task** appears.
  - 13 Print or export the results if needed.

14 Tap ✓ **Complete**.

➔ After completing the task, the results are deleted from the **Results list**.

➔ The dosing head moves to **Home position**.

### 5.2.10.3 Performing a dilution with the QLX3 liquid module

This section presents an example of a dilution using the QLX3 liquid module. A certain amount of the initial solution is weighed manually. This is typical if only a small quantity of the initial solution is available. Based on a user-defined dilution factor, solvent is added through a liquid dosing head.

#### Setting up the method

- A QLX3 liquid module is installed on the balance.
  - A method **Automated solution prep.** has been created.
- 1 Open the **Methods** section.
  - 2 Select a method **Automated solution prep.** from the **Methods list**.
  - 3 Tap ✎ **Edit**.

#### Editing Solution

- 1 Tap 📄 **Solution**.
- 2 Set **Type** to **Dilute solution**.
- 3 Type in any **Concentration unit**, for example, mg/g.
- 4 Fill in the **Initial solution conc.**, for example, 1 mg/g.
- 5 Enable **Check for overflow**.
- 6 Check that **Weighing type** of **Component 1** is set to **Manual weighing**.

#### Editing ID format

- 1 Tap 🏷️ **ID format**.
- 2 Keep the default settings.

#### Editing Weighing

- 1 Tap ⚖️ **Weighing**.
- 2 Make sure that the selected **Tolerance profile (liquid)** uses a maximum of four digits. If using a balance with a readability of six digits, the **Value release** must be set to **Fast** or **Very fast**.

#### Editing Weighing item

- 1 Tap 📦 **Weighing item**.
- 2 Set **Dilution factor** to, for example, 10.
- 3 Set **Target weight** to, for example, 10 g.
- 4 Type in the name of the initial solution manually in **Substance** of **Component 1**.
- 5 Set the **+Tolerance** and **-Tolerance** of **Component 1** to, for example, 10%.

#### Editing Automation

- 1 Tap ⚙️ **Automation**.
- 2 Keep the default settings.

#### Editing Print / Export

- 1 Keep the default **Print / Export** settings.
- 2 Tap ✓ **Save**.



## Running the method

- A QL3 pump is connected to the balance.
  - A bottle with the required solvent and liquid dosing head is attached to the pump.
  - The liquid dosing head is attached to the QLX3 liquid module.
  - The weighing pan or ErgoClip/adaptor is installed and empty.
- 1 Select the method from the **Methods list**.
  - 2 Tap ► **Start method**.
    - ➔ The main weighing screen appears with the selected method.
  - 3 To edit the parameters of the solution, tap 🧪. Save with ✓ **OK**.

**Note**  
Editing the settings of the solution through the weighing screen will apply to this task, but the changes will not be saved to the method itself.
  - 4 Press →**0**← to zero the balance.
  - 5 When you are ready to start weighing, tap ✓ **OK**.
  - 6 Place the sample vessel on the weighing pan or on the ErgoClip/adaptor.
  - 7 Close the draft shield.
  - 8 Tap ✓ **OK** to tare the balance.
    - ➔ The balance is taring.
  - 9 Manually weigh the amount of **Component 1** as indicated by the **Target weight** on the SmartTrac.
  - 10 Tap + **Add result**.
    - ➔ The weighing result of **Component 1** is saved to the **Results list**.
    - ➔ The balance is taring.
    - ➔ The liquid is added to the sample vessel to complete the dilution.
    - ➔ The weighing result is saved to the **Results list**.
  - 11 Tap 📄 **Complete** to open the printing options.
    - ➔ The dialog **Complete task** appears.
  - 12 Print or export the results if needed.
  - 13 Tap ✓ **Complete**.
    - ➔ After completing the task, the results are deleted from the **Results list**.

### 5.2.11 Editing a method

To clone a method proceed as follows:

- 1 Open the **Methods** section.
- 2 Select the method that you want to edit.
  - ➔ The line color of the selected method becomes blue.
- 3 Tap ✏ **Edit**.

For details about method settings:

#### See also

🔗 Weighing methods settings ► Page 125

### 5.2.12 Cloning a method

To simplify the process to create a method, an existing method can be cloned one or several times. The cloned method will have the same parameter values as the original one. If multiple weighing items exist in the original method, those will be cloned as well.

- 1 Open the **Methods** section.
- 2 Tap the method that you want to clone.

➔ The line color of the selected method becomes blue.

3 Tap  **Clone**.

➔ A copy of the selected method appears in the list. The cloned method has the same settings as the original method.

 **Note**

A method can be cloned several times. The name of the cloned method is always based on its original name, to which is appended a number.

### 5.2.13 Deleting a method

Both factory defined methods and user defined methods can be deleted if they are not needed. For this purpose proceed as follows:

1 Open the **Methods** section.

2 Tap the method that you want to delete.

➔ The line color of the selected method becomes blue.

3 Tap  **Delete**.

➔ The message **Delete method and cancel tasks?** appears on the screen.

4 Tap  **OK** to delete the selected method.

➔ The system returns to the method list. The method has been deleted and does not appear on the list anymore.

 **Note**

There is always a method activated in the background. This method can not be directly deleted. To delete the method, another method must be started instead. Now the method is not activated anymore and can be deleted.

### 5.2.14 Deleting a task

A method will be held as a task in the task section of the methods menu. It will be paused as a task if any other method is launched without the current method being completed. The method can be paused if it contains one or more weighing results, or has had certain method settings changed.

≡ **Navigation:** ▼ **Methods** >  **Tasks**

A task can only be deleted when not in use. The method that is currently used in the background is labeled with the symbol  in the tasks lists. To cancel the task, another task must be activated.

1 Select the task to be deleted and tap  **Cancel**.

➔ The dialog  **Cancel task?** opens.

2 To delete the task tap  **OK**, to cancel the delete procedure tap  **Cancel**.

### 5.2.15 Using methods with multiple weighing items (itemized)

Working with itemized methods can simplify the workflow, especially when several weighings with different predefined target weights have to be carried out one after the other. Information such as a target weight and tolerances can be defined for each weighing item within a single task. This may save time and increase quality of weighing processes consisting of multiple steps.

Before multiple weighing items can be used in the weighing process, they must be defined. The two ways of creating a weighing method that includes several weighing items are:

- Directly define the multiple weighing items during the method creating process.
- Use the **Results list** of a running method to define a new method with multiple weighing items.

The following methods use multiple weighing items:

- **General weighing (itemized)**
- **Simple formulation (itemized)**
- **Automated dosing (itemized)**

- **Automated solution prep. (itemized)**

### 5.2.15.1 Creating a new method with multiple weighing items (itemized)

This example describes how to define multiple weighing items for the method **General weighing (itemized)**.

- 1 Open the **Methods** section.
- 2 Tap **+ New** in the action bar.
- 3 Tap **Method type** and select **General weighing (itemized)**.
- 4 Step through the method wizard until step **4. Weighing items**.
  - ➔ The dialog **4. Weighing items** appears.
- 5 Select a weighing item from the list and define the **Sample ID**, **Unit**, **Target weight**, **-Tolerance**, and **+Tolerance**.
- 6 Tap **→ Next**.
- 7 Tap **✓ Finish**.
  - ➔ The method has been created and appears in the list.

### 5.2.15.2 Creating an itemized method from a completed task

It is possible to create a method with multiple items while performing a method that includes a single item, providing that the method type allows it. This example describes how to create a method **General weighing (itemized)** based on a method **General weighing**.

- 1 Start a method **General weighing**.
- 2 Perform three weighings and add the results to the **Results list** by tapping **+ Add result**.
  - ➔ The results are saved to the **Results list**.
- 3 Tap **⋮ More**.
- 4 Tap **📄 Save as method (itemized)**.
- 5 Define a **Method name**.
- 6 Tap **✓ OK**.
  - ➔ A method **General weighing (itemized)** including three items is created and added to the **Methods list** with the name defined by the user.

### 5.2.15.3 Performing an itemized method

After creating a method with multiple items, it can be started.

- 1 Open the **Methods** section.
- 2 Select an itemized method from the **Methods list**.
- 3 Tap **▶ Start method**.
  - ➔ The main weighing screen opens. The target weight and the tolerance limits defined in the method appear.

## 5.3 Test weights

### 5.3.1 Defining an individual test weight

The user should enter data related to each test weight based on the corresponding certificate. This enables each external test weight to be clearly assigned to a specific certificate. Up to 12 external test weights can be configured. These test weights can be used to carry out external tests and adjustments.

☰ **Navigation:** ▼ **Methods** > 📄 **Tests** > 📄 **Test weights**

#### **i** Note

An external test weight for an external adjustment has to weigh at least 10% of the balance capacity. External test weights under 10% of the balance capacity are not displayed on the balance.

- The dialog **Test weights** is open.
- 1 Tap **+ Test weight**.
- 2 Define the test weight settings and confirm with **✓ Finish**.
- ➔ The test weight is defined and will be available later in the test procedure.

### 5.3.2 Defining a combined test weight

The user can combine test weights to achieve a test weight capacity that is not available as a single standard weight. For example, a weight of 10 g and a weight of 20 g can be combined and used as a test weight of 30 g. Each combined test weight can include two or three test weights. The class of a specific combined weight can only be as good as the worst class of the individual test weights it contains. As for any other test weight, combined test weight can be used to carry out external tests and adjustments.

☰ **Navigation:** ☰ **Methods** > ⚙ **Tests** > ⚙ **Test weights**

- The dialog **Test weights** is open.
- At least two individual test weights are defined.
- 1 Tap **⚙ Combined weight**.
- 2 Enter a **Test weight name**.
- 3 Select the **Minimum weight class** for the combined weight.
- 4 Tap **Weights**.
  - ➔ The individual weights of at least **Minimum weight class** are shown.
- 5 Select the weights to include in the combined weight.
- 6 Tap **✓ OK**.
  - ➔ The **Nominal weight** is calculated as the sum of the selected individual weights.
- 7 Tap **✓ Save**.
- ➔ The combined test weight is defined and will be available later in the test procedure.

## 5.4 Tests

Routine tests can be performed to ensure accurate weighing results according to GWP® or other QM systems. Therefore the tests should be performed in fixed, regular intervals depending on your QM system and the results should be documented in a traceable way.

☰ **Navigation:** ▼ **Methods** > ⚙ **Tests**

### 5.4.1 Overview routine tests

METTLER TOLEDO can help you to define the routine tests to be performed based on your process requirements. Please contact your local METTLER TOLEDO representative for additional information.

#### 5.4.1.1 Eccentricity test

The purpose of the eccentricity test is to check if every eccentric load deviation (corner load deviation) is within the user SOP tolerances. The corner load is the deviation of the measurement value through off-center (eccentric) loading. The corner load increases with the weight of the load and its distance from the center of the weighing pan support (1). If the display remains consistent, even when the same load is placed on different parts of the weighing pan, the balance does not have corner load deviation.

The result corresponds to the highest of the four determined eccentric load deviations (2 to 5).

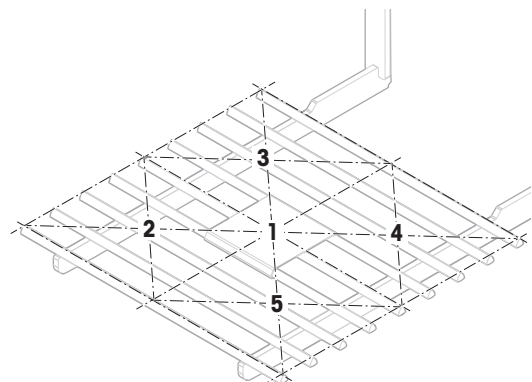

### 5.4.1.2 Repeatability test

The repeatability test calculates the standard deviation of a series of measurements with a single test weight in order to determine the repeatability of the balance.

Repeatability is a measure of the ability of a balance to supply the same result in repetitive weighings with one and the same load under the same measurement conditions. During the test, a load is placed and measured at the same location on the weighing pan several times. Afterwards, the difference between the measured weight values is calculated. The spread of the measured results leads to the repeatability.

Repeatability is highly affected by the ambient conditions (drafts, temperature fluctuations and vibrations) and also by the skill of the person performing the weighing. Therefore, the series of measurements must be carried out by the same operator, in the same location, under constant ambient conditions and without interruption.

The following test types are available:

- **Repeatab. - 1 TP:** To test the repeatability of the balance at one test point, without tare weight.
- **Repeatab. - Tare - 1 TP:** To test the repeatability of the balance at one test point, with a tare weight.
- **Auto. Repeat. - Tare - 1 TP:** To test the automatic repeatability of the balance at one test point, with tare weight. This test is only available for automatic balances and must be performed with the weight test head.

### 5.4.1.3 Sensitivity test



The sensitivity of the balance defines the deviation between the balance reading and the actual load. The sensitivity test allows you to measure the sensitivity using one or two test points.

The following test types are available:

- **Sensitivity - 1 TP:** To test the sensitivity of the balance at one test point, without tare weight.
- **Sensitivity - 2 TP:** To test the sensitivity of the balance at two test points, without tare weight.
- **Sensitivity - Tare - 1 TP:** To test the sensitivity of the balance at one test point, with a tare weight.
- **Sensitivity - Tare - 2 TP:** To test the sensitivity of the balance at two test points, with a tare weight.

## 5.4.2 Creating a new test

Before a test can be performed, the test settings have to be defined. A test wizard is leading you step-by-step through the process.

- 1 Open the **Methods** section.
- 2 Tap  **Tests**.
- 3 Tap  **New**.
  - ➔ The wizard **Create new test** starts.
- 4 Select the test type.
- 5 Work through the process by using the button **→ Next** to go to the next step or the button **← Back** to go back to the previous step.

For details about test settings:

#### See also

 Tests settings ▶ Page 202

## 5.4.3 Performing a test



### NOTICE

#### **Incorrect weighing results due to wrong handling of the test weights.**

- Only handle test weights with gloves, tweezers, weight forks, or weight handles.

You can perform an eccentricity test, a repeatability test or a sensitivity test. Which test you have to perform and when depends on the respective weighing processes. Mettler-Toledo GmbH can help you to define the routine tests to be performed based on your process requirements. Please contact your local METTLER TOLEDO representative for additional information.

Moments when tests could be performed:

- After cleaning
- After a software update
- Daily before putting into operation
- Depending on own SOP

Requirements:

- At least one test weight is defined.
- At least one sensitivity, one repeatability or one eccentricity test is created.

All of the following pictured test weights or vessels are examples. Actual test weights or vessels may look different.

#### See also

- 🔗 Defining an individual test weight ▶ Page 65
- 🔗 Defining a combined test weight ▶ Page 66

### 5.4.3.1 Performing an "Eccentricity test"

- 1 Open the **Methods** section.
- 2 Tap **Tests**.
  - ➔ The test(s) previously defined appear on the list.
- 3 Select the eccentricity test you wish to perform and tap **Start**.
  - ➔ The test sequence starts.
- 4 Ensure that the weighing pan is empty and clean. Have at hand: the test weight, gloves, and the appropriate tools to handle the test weight.
- 5 When all requirements are fulfilled tap **OK**.
- 6 Make sure that the weighing pan is empty and tap **OK**.
  - ➔ The door closes automatically (depending on the door settings) and the balance starts an automatic zeroing.
- 7 Choose an available test weight  
- or -  
add a new test weight and tap **OK**.
- 8 Open the door and place the test weight (1) carefully in position 1, in the middle of the weighing pan (2).
  - ➔ The measurement starts with **Capturing weight....**
  - ➔ The door closes automatically (depending on the door settings).
  - ➔ When the measurement is finished, the door opens automatically (depending on the door settings).
  - ➔ The result of the first measurement is added to the **Results list** as **Position 1**.

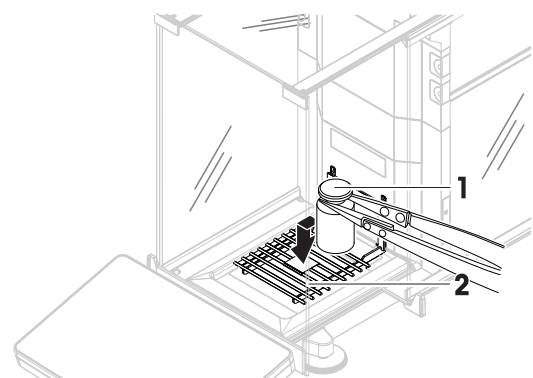

- 9 Lift the test weight and move to position 2 (front left corner of the weighing pan).
- ➔ The measurement starts with **Capturing weight...**
  - ➔ The door closes automatically (depending on the door settings).
  - ➔ When the measurement is finished, the door opens automatically (depending on the door settings).
  - ➔ The result of the second measurement is added to the **Results list** as **Position 2**.

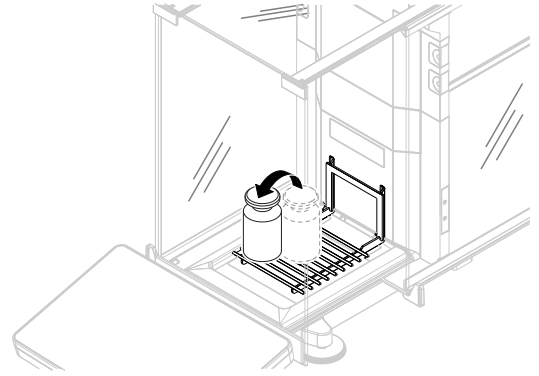

- 10 Lift the test weight and move to position 3 (back left corner of the weighing pan).
- ➔ The measurement starts with **Capturing weight...**
  - ➔ The door closes automatically (depending on the door settings).
  - ➔ When the measurement is finished, the door opens automatically (depending on the door settings).
  - ➔ The result of the third measurement is added to the **Results list** as **Position 3**.

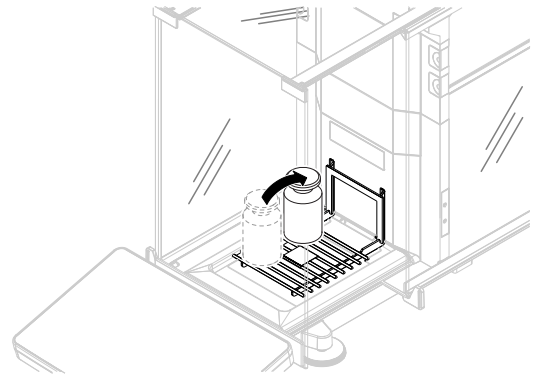

- 11 Lift the test weight and move to position 4 (back right corner of the weighing pan).
- ➔ The measurement starts with **Capturing weight...**
  - ➔ The door closes automatically (depending on the door settings).
  - ➔ When the measurement is finished, the door opens automatically (depending on the door settings).
  - ➔ The result of the fourth measurement is added to the **Results list** as **Position 4**.

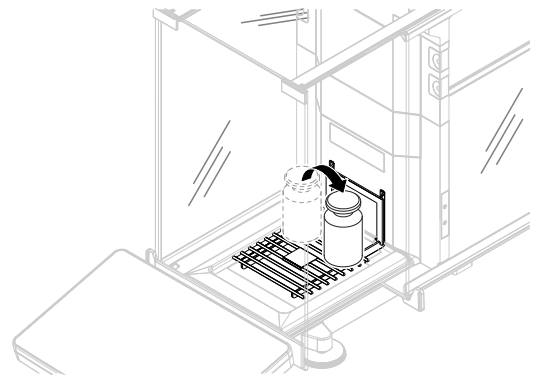

- 12 Lift the test weight and move to position 5 (front right corner of the weighing pan).
- ➔ The measurement starts with **Capturing weight...**
  - ➔ The door closes automatically (depending on the door settings).
  - ➔ When the measurement is finished, the door opens automatically (depending on the door settings).
  - ➔ The result of the fifth measurement is added to the **Results list** as **Position 5**.
  - ➔ The eccentricity test is finished.

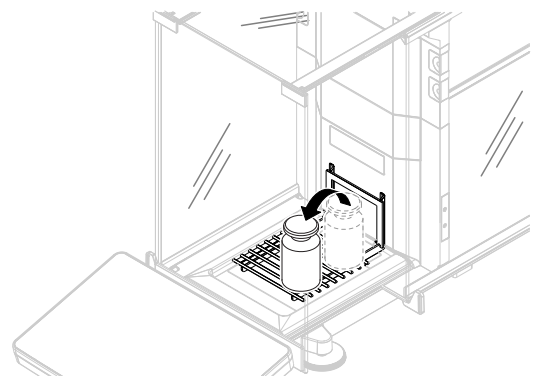

- 13 Remove the test weight carefully and tap **✓ OK**.
- ➔ The door closes automatically (depending on the door settings) and the balance starts an automatic zeroing.
- 14 When the test procedure is finished, tap **Finish**.
- ➔ The result dialog opens.
- 15 To print the results tap **Print**, to finish the test tap **✓ Finish**.

## Test result

If the test failed, see "Troubleshooting", search the error, remedy it and test again. If the test fails again, contact a METTLER TOLEDO representative.



## See also

 Settings: Eccentricity ▶ Page 202

### 5.4.3.2 Performing a "Repeatability test"

In this section, all repeatability tests are described. Which test you use depends on the respective test target.

#### Repeatability - 1 test point

- 1 Open the **Methods** section.
- 2 Tap  **Tests**.
  - ➔ The test(s) previously defined appear on the list.
- 3 Select the repeatability test you wish to perform and tap ▶ **Start**.
  - ➔ The test sequence starts.
- 4 Ensure that the weighing pan is empty and clean. Have at hand: the test weight, gloves, and the appropriate tools to handle the test weight.
- 5 When all requirements are fulfilled tap ✓ **OK**.
- 6 Make sure that the weighing pan is empty and tap ✓ **OK**.
  - ➔ The door closes automatically (depending on the door settings) and the balance starts an automatic zeroing.
- 7 Choose an available test weight  
- or -  
add a new test weight and tap ✓ **OK**.
- 8 Open the door and place the test weight (1) carefully on the weighing pan (2).
  - ➔ The measurement starts with **Capturing weight....**
  - ➔ The door closes automatically (depending on the door settings).
  - ➔ When the measurement is finished, the door opens automatically (depending on the door settings).
  - ➔ The result of the measurement is added to the **Results list**.
- 9 Remove the test weight carefully and tap ✓ **OK**.
  - ➔ The door closes automatically (depending on the door settings) and the balance starts an automatic zeroing.
  - ➔ Depending on the specified **Number of repetitions** you have to repeat the last two steps a certain number of times.
- 10 When the test procedure is finished, tap  **Finish**.
  - ➔ The result dialog opens.
- 11 To print the results tap  **Print**, to finish the test tap ✓ **Finish**.

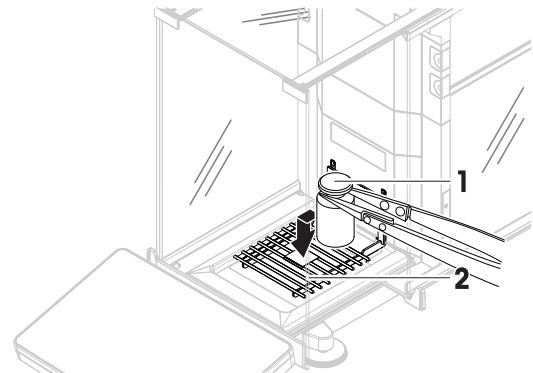

#### Repeatability - Tare - 1 test point

- 1 Open the **Methods** section.
- 2 Tap  **Tests**.
  - ➔ The test(s) previously defined appear on the list.
- 3 Select the repeatability test you wish to perform and tap ▶ **Start**.
  - ➔ The test sequence starts.



- 4 Ensure that the weighing pan is empty and clean. Have at hand: the test weight, gloves, and the appropriate tools to handle the test weight.
- 5 When all requirements are fulfilled tap **✓ OK**.
- 6 Make sure that the weighing pan is empty and tap **✓OK**.
  - ➔ The door closes automatically (depending on the door settings) and the balance starts an automatic zeroing.
- 7 Choose an available test weight/test container  
- or -  
add a new test weight/test container.
- 8 Place the test weight/test container (1) in the center of the weighing pan (2) and tap **✓ OK**.
  - ➔ The door closes automatically (depending on the door settings) and the measurement starts with **Taring...**
  - ➔ When the tare is finished, the door opens automatically (depending on the door settings).
  - ➔ The tare result is added to the **Results list**.
- 9 Carefully place the test weight (3) onto the weighing pan or into the tare container (4).
  - ➔ The measurement starts with **Capturing weight...**
  - ➔ The door closes automatically (depending on the door settings).
  - ➔ When the measurement is finished, the door opens automatically (depending on the door settings).
  - ➔ The result of the measurement is added to the **Results list**.
- 10 Remove the test weight, leave the container on the weighing pan.
  - ➔ The door closes automatically (depending on the door settings) and the measurement starts with **Taring...**
  - ➔ When the tare is finished, the door opens automatically (depending on the door settings).
  - ➔ The tare result is added to the **Results list**.
- 11 Carefully place the test weight (3) onto the weighing pan or into the tare container (4).
  - ➔ The measurement starts with **Capturing weight...**
  - ➔ The door closes automatically (depending on the door settings).
  - ➔ When the measurement is finished, the door opens automatically (depending on the door settings).
  - ➔ The result of the measurement is added to the **Results list**.
  - ➔ Depending on the specified **Number of repetitions** you have to repeat the last two steps a certain number of times.
- 12 When the test procedure is finished, tap **🖨️ Finish**.
  - ➔ The result dialog opens.
- 13 To print the results tap **🖨️ Print**, to finish the test tap **✓ Finish**.

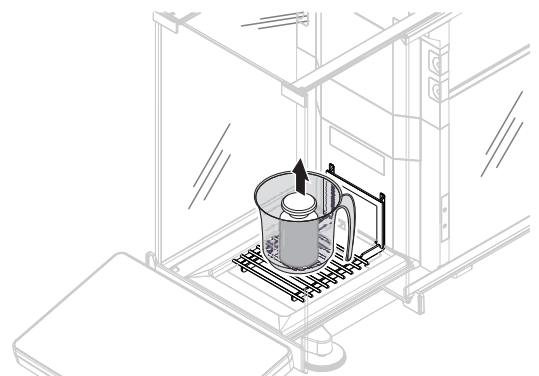
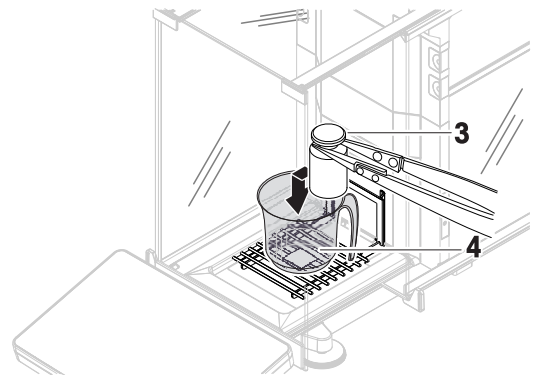
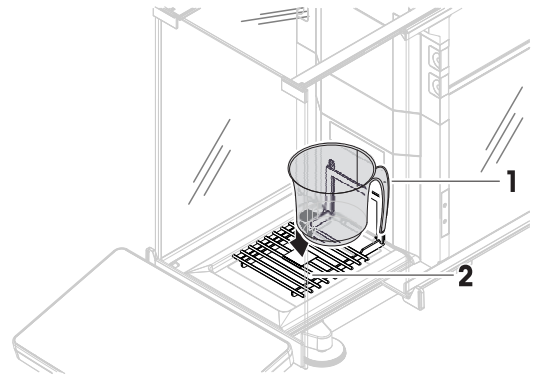

## Test result

If the test failed, see "Troubleshooting", search the error, remedy it and test again. If the test fails again, contact a METTLER TOLEDO representative.



## Automated repeatability - Tare - 1 test point

The automated repeatability test is performed with the weight test head, available as accessory, see [Accessories ▶ Page 236]. For more information about how to set up the weight test head, consult the Reference Manual provided with it.

### 5.4.3.3 Performing a "Sensitivity test"

In this section, two of four possible sensitivity tests are described. Which test you use depends on the respective test target. The procedure for the tests with two test points is similar, but additional test weights and test containers are necessary.

#### Sensitivity - 1 test point

- 1 Open the **Methods** section.
- 2 Tap  **Tests**.
  - ➔ The test(s) previously defined appear on the list.
- 3 Select the sensitivity test you wish to perform and tap ▶ **Start**.
  - ➔ The test sequence starts.
- 4 Ensure that the weighing pan is empty and clean. Have at hand: the test weight, gloves, and the appropriate tools to handle the test weight.
- 5 When all requirements are fulfilled tap ✓ **OK**.
- 6 Make sure that the weighing pan is empty and tap ✓ **OK**.
  - ➔ The door closes automatically (depending on the door settings) and the balance starts an automatic zeroing.
- 7 Choose an available test weight  
- or -  
add a new test weight and tap ✓ **OK**.
- 8 Open the door and place the test weight (1) carefully on the weighing pan (2).
  - ➔ The measurement starts with **Capturing weight....**
  - ➔ The door closes automatically (depending on the door settings).
  - ➔ When the measurement is finished, the door opens automatically (depending on the door settings).
  - ➔ The result of the measurement is added to the **Results list**.
- 9 When the test procedure is finished, tap  **Finish**.
  - ➔ The result dialog opens.
- 10 To print the results tap  **Print**, to finish the test tap ✓ **Finish**.

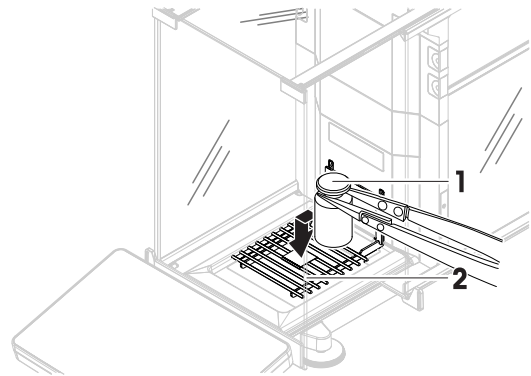

#### Sensitivity - Tare - 1 test point

- 1 Open the **Methods** section.
- 2 Tap  **Tests**.
  - ➔ The test(s) previously defined appear on the list.
- 3 Select the sensitivity test you wish to perform and tap ▶ **Start**.
  - ➔ The test sequence starts.
- 4 Ensure that the weighing pan is empty and clean. Have at hand: the test weight, gloves, and the appropriate tools to handle the test weight.

- 5 When all requirements are fulfilled tap ✓ **OK**.
- 6 Make sure that the weighing pan is empty and tap ✓ **OK**.
  - ➔ The door closes automatically (depending on the door settings) and the balance starts an automatic zeroing.
- 7 Choose an available test weight/test container - or - add a new test weight/test container.
- 8 Place the test weight/test container (1) in the center of the weighing pan (2) and tap ✓ **OK**.
  - ➔ The door closes automatically (depending on the door settings) and the measurement starts with **Taring...**
  - ➔ When the tare is finished, the door opens automatically (depending on the door settings).
  - ➔ The tare result is added to the **Results list**.
- 9 Carefully place the test weight (3) onto the weighing pan or into the tare container (4).
  - ➔ The measurement starts with **Capturing weight...**
  - ➔ The door closes automatically (depending on the door settings).
  - ➔ When the measurement is finished, the door opens automatically (depending on the door settings).
  - ➔ The result of the measurement is added to the **Results list**.
- 10 When the test procedure is finished, tap 🖨 **Finish**.
  - ➔ The result dialog opens.
- 11 To print the results tap 🖨 **Print**, to finish the test tap ✓ **Finish**.

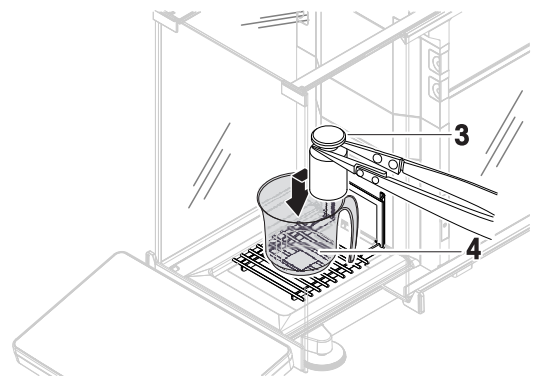
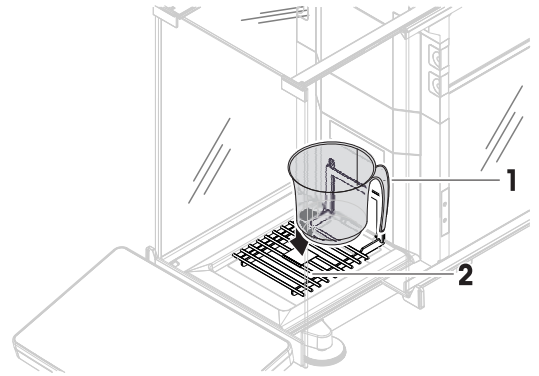

### Test result

If the test failed, see "Troubleshooting", search the error, remedy it and test again. If the test fails again, contact a METTLER TOLEDO representative.

### See also

🔗 Settings: Sensitivity test ▶ Page 209

## 5.4.4 Editing a test

A test can only be edited when it is not running.

☰ **Navigation:** ▼ **Methods** > 🛠 **Tests**

- 1 Select the test to be edited from the list and tap ✎ **Edit**.
  - ➔ The test settings open.
- 2 Edit the test settings.





## 5.4.5 Printing test results

You can print a test manually, whether the parameter **Automatic print** in the test settings is activated or deactivated. For this purpose proceed as follows:

- 1 Open the **Methods** section.
- 2 Tap 🛠 **Tests**.
  - ➔ The test list opens.

- 3 Select the test to print and tap  **Print all**.
- ➔ The test is printed.

### 5.4.6 Deleting a test

- 1 Open the **Methods** section.
- 2 Tap  **Tests**.
  - ➔ The test list opens.
- 3 Select the test to delete.
- 4 Tap  **Delete**.
  - ➔ The section **Delete routine test** opens. The message **Do you really want to delete the selected routine test?** appears.
- 5 Tap  **Yes** to delete the test. Tap  **No** to cancel the deleting process.
  - ➔ After deleting the test, the system returns to the test list. The test has been deleted and does not appear on the list anymore.

Running tests are labeled with the symbol  and cannot be deleted. To delete a test, it must be finished or another test must be activated. To delete a test, proceed as follows:

### 5.4.7 Consulting the test history

≡ **Navigation:** ▶ **Balance menu** >  **History** >  **Tests**

- Select a test.
- ➔ The test history opens. Specific data are displayed for each test, such as the date and time, type of test, temperature, level state, test weight ID, and weight deviation.

#### See also

 [History](#) ▶ Page 106



## 5.5 Adjustments

This section describes how internal and external adjustments can be defined and performed. Which type of adjustment is performed depends on the defined adjustment **Strategy**.

≡ **Navigation:** ▼ **Methods** >  **Adjustments**

### 5.5.1 Internal adjustment

#### 5.5.1.1 Editing an "Internal adjustment"



- 1 Open the **Methods** section.
- 2 Tap  **Adjustments**.
- 3 Tap  **Edit**.
- 4 Set the **Strategy** to **Internal adjustment**.
- 5 Define the adjustment parameters.
- 6 Tap  **Save**.
  - ➔ Your internal adjustment has been edited.

For details about adjustment settings:

#### See also







 [Adjustments settings](#) ▶ Page 213

### 5.5.1.2 Performing an "Internal adjustment"

- The adjustment **Strategy** is set to **Internal adjustment**.
- 1 Open the **Methods** section, tap  **Adjustments**, select the adjustment, and tap ► **Start**  
- or -  
from the main weighing screen, tap **⋮ More** and tap **Start adjustment**.
  - ➔ **Internal adjustment** is being executed.
  - ➔ When the adjustment has been completed, an overview of the adjustment results appears.
- 2 Tap  **Print** if you want to print the results.
- 3 Tap  **Finish adjustment**.
  - ➔ The balance is ready.

## 5.5.2 External adjustment

### 5.5.2.1 Editing an "External adjustment"

- 1 Open the **Methods** section.
- 2 Tap  **Adjustments**.
- 3 Tap  **Edit**.
- 4 Set the **Strategy** to **External adjustment**.
- 5 Tap  **Test weights - Edit test weight**.
  - ➔ The dialog **Test weights - Edit test weight** opens.
- 6 Select a test weight from the list and tap  **OK**  
- or -  
tap  **Test weight** to define a new test weight.
- 7 Define the test weight settings and confirm with  **OK**.
- 8 Tap  **Save**.
  - ➔ Your external adjustment has been edited.





For details about adjustment settings:

#### See also

 [Adjustments settings](#) ► Page 213

### 5.5.2.2 Performing an "External adjustment"



After the external weights have been defined, the function **External adjustment** can be performed.

- The adjustment **Strategy** is set to **External adjustment**.
- 1 Open the **Methods** section, tap  **Adjustments**, select the adjustment, and tap ► **Start**  
- or -  
from the main weighing screen, tap **⋮ More** and tap **Start adjustment**.
  - ➔ The adjustment process starts.
- 2 Ensure that the weighing pan is empty and clean. Have at hand: the test weight, gloves, and the appropriate tools to handle the test weight.
- 3 When all requirements are fulfilled tap  **OK**.
- 4 Make sure that the weighing pan is empty and tap  **OK**.
- 5 Choose an available test weight  
- or -  
add a new test weight and tap  **OK**.

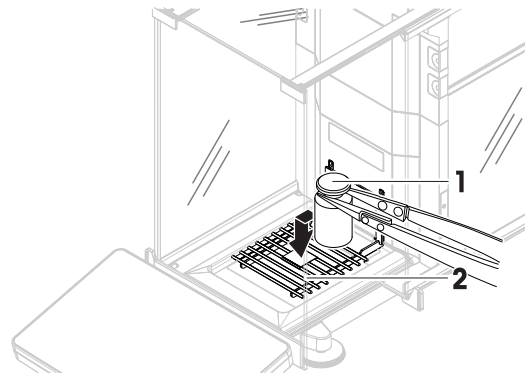
- 6 Open the door and place the test weight (1) carefully on the weighing pan (2).
  - ➔ The door closes and the adjustment starts.
  - ➔ After a few seconds the door opens.
- 7 Remove the test weight from the weighing pan and tap **✓ OK**.
  - ➔ The door closes and opens. The adjustment is finishing and the adjustment results appear.
- 8 To print the results tap  **Print**, to finish the test tap **✓ Finish**.



**See also**

-  Defining an individual test weight ▶ Page 65
-  Defining a combined test weight ▶ Page 66

### 5.5.3 Consulting the adjustment history

☰ **Navigation:** ▶ **Balance menu** >  **History** >  **Adjustments**

- Select an adjustment.
- ➔ The adjustment history opens. Specific data are displayed for each adjustment such as the date and time, type of adjustment, temperature, level state, adjustment trigger, and correction.

**See also**

-  History ▶ Page 106

## 5.6 Peripheral devices

### 5.6.1 Printer

Printers can help document your processes and results. Two types of printers can be connected to the balance:

- strip printer: to print on strip paper, for example, for the documentation of weighing result
- label printer: to print on label stickers, for example, for the identification of samples

Each weighing method offers the possibility to trigger the printing process manually on a label or on strip paper when completing a task. The settings of the method can also be edited such that the results are automatically printed when a result is added to the result list or when the task is complete, for example. When using a label printer, the template of the printed label is defined individually for each method.

The following sections show typical use cases of installing and using a printer with the balance. They cover two combinations of settings amongst: manual and automatic printing, strip and label printing, task results and weighing item results printing, as well as USB and Bluetooth connections. Other combinations of settings can be achieved similarly.



#### NOTICE

##### Damage to the device due to inappropriate use

- Consult the User Manual of the device before using it.

#### 5.6.1.1 Printing results manually on a strip printer via USB

This example describes how to install a strip printer using a USB cable. For this example, the method does not include automatic printing, but the results are printed manually when the task is completed.

## Installing and configuring the printer

- The printer is connected to the power outlet and switched on.
  - The USB cable is connected to the printer.
  - The main weighing screen is shown on the balance terminal.
- 1 Connect the USB cable to one of the USB-A ports of the balance.
    - ➔ The balance detects the USB device automatically. The dialog **Add device** appears, informing the user that the system has found a specific device.
  - 2 Set a name for the USB device, then tap → **Next**.
  - 3 Tap ✓ **Finish**.
    - ➔ The USB device is connected and saved to the system.
    - ➔ The settings of the device are displayed.
  - 4 Tap **Printer settings**.
  - 5 Tap **Printer category** and select **Strip printer**.
  - 6 Tap ✓ **Save**.

### **Note**

Some printers can print both on labels or on strip paper. In those cases, the printer type must be specified in the settings of the printer. If the printer can only print on labels or can only print on strip paper, the printer type is set automatically.

### **Note**

A label printer and a strip printer can be connected simultaneously to the balance. However, only one printer of a specific type can be active at any given time. When connecting a new printer of the same type, the printer of the same type that was previously active is deactivated automatically. After connecting a new printer, verify the status of all other printers.

### **Note**

If the USB cable is disconnected and reconnected, the connection will be detected automatically. The printer does not need to be installed again.

## Printing a test page

After installing and configuring a printer, a test page can be printed.

≡ **Navigation:** ▶ **Balance menu** > ⚙ **Settings** > 🖨 **Devices / Printers**

- A printer is connected to the balance.
- 1 Navigate to the section 🖨 **Devices / Printers**.
  - 2 Select the printer in the list of devices.
  - 3 Tap ✓ 🖨 **Print test page** in the action bar.

## Printing the results

≡ **Navigation:** ▼ **Methods** > 📄 **Methods list**

- A strip printer is connected to the balance.
- 1 Select a method from the **Methods list**.
  - 2 Tap ▶ **Start method**.
  - 3 Perform the necessary actions to weigh your sample(s).
  - 4 Tap 📄 **Complete** to open the export options.
    - ➔ The dialog **Complete task** appears.
  - 5 Tap **Print results manually** to print the results on the strip printer.

## See also

🔗 [Devices / Printers](#) ▶ Page 121

### 5.6.1.2 Printing results automatically on a label printer via Bluetooth

This example describes how to install a label printer using a Bluetooth adapter. For this example, the method is set such that a label is printed automatically every time the user taps **Add result**.



For more information about how to install your Bluetooth adapter, consult the Installation Instructions provided with it.

#### Installing and configuring the printer

Navigation: ► Balance menu > ⚙ Settings > 📶 Interfaces > 📶 Bluetooth

Navigation: ► Balance menu > ⚙ Settings > 🖨 Devices / Printers

- The printer is connected to the power outlet and switched on.
- A Bluetooth RS adapter (to connect to the printer) and a Bluetooth USB adapter (to connect to the balance) are available.
- The switch on the Bluetooth RS adapter is in the position DCE.
- You have identified the MAC address (unique device address) on the Bluetooth RS adapter.
- The main weighing screen is shown on the balance terminal.

1 Connect the Bluetooth USB adapter (1) to one of the USB-A ports (2) of the balance.

2 Connect the Bluetooth RS adaptor (3) to the printer (4).

➔ The lights on the Bluetooth RS adaptor start blinking.

3 Navigate to the section 📶 Bluetooth.

4 Set **Activation** to **Active**.

5 Tap ✓ **Save**.

6 Navigate to the section 🖨 Devices / Printers.

7 Tap + **Add device**.

➔ The dialog **Add device** opens.

8 Select **Bluetooth connection** and tap → **Next**.

➔ The message **Searching for devices...** appears.

➔ The MAC addresses of all the available Bluetooth devices appear.

9 Select the MAC address of the Bluetooth RS adapter from the list and tap → **Next**.

10 Check that the **PIN Code** is correct: [Mettler-Toledo](#).

11 Tap → **Next** to confirm the Bluetooth connection.

➔ The balance is pairing the Bluetooth USB adapter from the balance with the Bluetooth RS adapter from the printer.

➔ The system informs the user that it has found the device.

12 Set a name for the USB device, then tap → **Next**.

13 Tap ✓ **Finish**.

➔ The USB device is connected and saved to the system.

➔ The settings of the device are displayed.

14 Tap **Printer settings**.

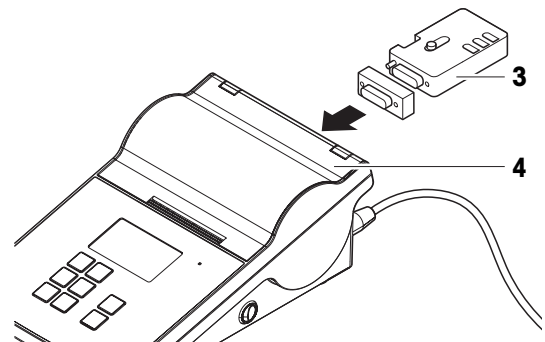
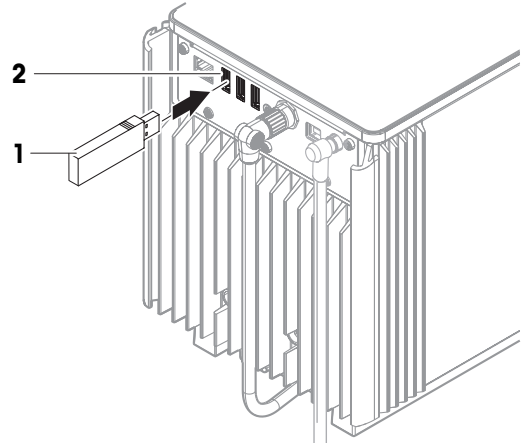



15 Tap **Printer category** and select **Label printer**.

16 Tap **✓ Save**.

**Note**

When setting up the Bluetooth connection, the balance pairs with the Bluetooth RS adaptor, not with the printer that is attached to it. When the user connects the same Bluetooth RS adaptor to another printer, the user must remove the configured printer from the list of devices and add the new printer.

**Note**

Some printers can print both on labels or on strip paper. In those cases, the printer type must be specified in the settings of the printer. If the printer can only print on labels or can only print on strip paper, the printer type is set automatically.

**Note**

A label printer and a strip printer can be connected simultaneously to the balance. However, only one printer of a specific type can be active at any given time. When connecting a new printer of the same type, the printer of the same type that was previously active is deactivated automatically. After connecting a new printer, verify the status of all other printers.

**Note**

If the USB adaptor is removed from the balance and plugged in again, the Bluetooth connection will be detected automatically. This may take up to 30 seconds.

### Printing a test page

After installing and configuring a printer, a test page can be printed.

Navigation: **► Balance menu > ⚙ Settings > 🖨 Devices / Printers**

- A printer is connected to the balance.
- 1 Navigate to the section **🖨 Devices / Printers**.
- 2 Select the printer in the list of devices.
- 3 Tap **🖨 Print test page** in the action bar.

### Editing the method settings

Navigation: **▼ Methods > 📄 Methods list**

- 1 Select a method from the **Methods list**.
- 2 Tap **✎ Edit**.
- 3 Tap **🖨 Print / Export**.
- 4 Tap **Label printout for weighing item**.
- 5 Set **Automatic label printout for weighing item** to **Active**.
- 6 Select the desired template from the list: **Used template**.
- 7 Tap **Field settings**.
- 8 Customize the content of each field.
- 9 Tap **✓ OK**.
- 10 Tap **✓ Save**.

### Printing the results

Navigation: **▼ Methods > 📄 Methods list**

- A label printer is connected to the balance.
- A method exists with the desired template for the printed label.
- 1 Select the method from the **Methods list**.
- 2 Tap **► Start method**.
- 3 Perform the necessary actions to weigh your sample.

4 Tap **+ Add result**.

➔ The label for this weighing item is automatically printed on the label printer.

#### See also

 [Bluetooth](#) ▶ Page 121

 [Devices / Printers](#) ▶ Page 121

## 5.6.2 Barcode reader

The barcode reader can be used to enter text or numbers in any input field on the terminal. The format of the field must be compatible with the scanned barcode. Depending on the settings of the weighing method, the characters of the barcode can be added to the active field or to a specific field of the method. The latter is depicted by the following example.



### NOTICE

#### Damage to the device due to inappropriate use

– Consult the User Manual of the device before using it.

### 5.6.2.1 Scan a sample ID using a barcode reader

This example shows how the barcode reader can be used to specify the ID of a sample in a method of type **General weighing**. A similar procedure can be applied to other method types and/or other input fields.

#### Installing and configuring the barcode reader

- A barcode reader is available.
- The main weighing screen is shown on the balance terminal.
- 1 Connect the USB cable to one of the USB-A ports of the balance.
  - ➔ The balance detects the USB device automatically. The dialog **Add device** appears and a barcode is displayed.
- 2 Use the barcode reader to scan the barcode on the display.
- 3 Tap **→ Next**.
- 4 Set a name for the USB device, then tap **→ Next**.
- 5 Tap **✓ Finish**.
  - ➔ The USB device is connected and saved to the system.
  - ➔ The settings of the device are displayed.
- 6 Tap **✓ Save**.
  - ➔ The barcode reader is ready to use.

#### Editing the method settings

☰ **Navigation:** ▼ **Methods** > ☰] **Methods list**

- A method **General weighing** exists.
- The method contains one **Result ID** for which **Result description** is set to **Sample ID**.
- 1 Select the method from the **Methods list**.
- 2 Tap **✎ Edit**.
- 3 Tap **⚙ Automation**.
- 4 Tap **Barcode data target** and select the **Result ID** corresponding to **Sample ID**, for example, **Result ID 1**.
- 5 Tap **✓ Save**.

## Running the method

### ☰ Navigation: ▼ Methods > ☰] Methods list

- The barcode reader is connected to the balance.
  - You have a sample identified with a barcode.
- 1 Select the method from the **Methods list**.
  - 2 Tap ► **Start method**.
  - 3 Use the barcode reader to scan the barcode that identifies your sample.
    - ➔ The text associated to the barcode appears in the field of **Sample ID**.
  - 4 Perform the necessary actions to weigh your sample.
  - 5 Tap + **Add result**.

### See also

🔗 Devices / Printers ► Page 121

## 5.6.3 RFID reader

Smart Tags are RFID stickers that you can attach to the bottom of sample vessels. They are used to store information about the sample. They are typically used with the method type **Titration**. The content of the Smart Tags can be accessed and edited using an RFID reader, for example, an EasyScan USB or a SmartScan.



### NOTICE

#### Damage to the device due to inappropriate use

- Consult the User Manual of the device before using it.

### See also

🔗 Performing a "Titration" ► Page 45

🔗 Devices / Printers ► Page 121

### 5.6.3.1 Reading data from an RFID Smart Tag using an EasyScan USB

This example describes how to use an EasyScan USB to read data from a Smart Tag.

#### Installing the EasyScan USB

- An EasyScan USB is available.
  - A USB-A to USB-B cable is available.
  - The main weighing screen is shown on the balance terminal.
- 1 Connect the USB cable to a USB-A port on the balance.
  - 2 Connect the USB cable to the USB-B port of the RFID reader.
    - ➔ The balance detects the USB device automatically. The dialog **Add device** appears, informing the user that the system has found a specific device.
  - 3 Set a name for the USB device, then tap → **Next**.
  - 4 Tap ✓ **Finish**.
    - ➔ The USB device is connected and saved to the system.
    - ➔ The settings of the device are displayed.
  - 5 Tap ✓ **Save**.

## Testing the RFID reader

≡ **Navigation:** ► **Balance menu** > ⚙️ **Settings** > 🖨️ **Devices / Printers**

- An RFID reader is installed on the balance.
  - A Smart Tag RFID tag is available.
- 1 Navigate to the section 🖨️ **Devices / Printers**.
  - 2 Select the device from the list of devices and printers.
  - 3 Tap 📄 **Test device**.
    - ➔ The dialog **Test RFID device** opens.
  - 4 Place an RFID tag on the RFID reader.
    - ➔ If the RFID reader works correctly, the message **RFID tag successfully detected.** is shown.
  - 5 Tap ✓ **OK**.
    - ➔ The RFID reader is working properly.

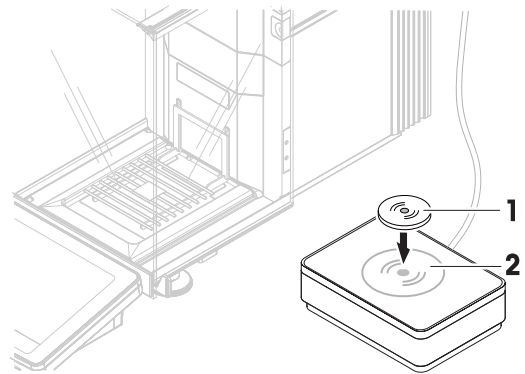

## Reading data from a Smart Tag

≡ **Navigation:** ► **Balance menu** > 🛠️ **Maintenance** > 📄 **Format RFID**

- An RFID reader is installed on the balance.
  - A Smart Tag RFID tag is available.
- 1 Navigate to the section 📄 **Format RFID**.
  - 2 Tap 📄 **Format RFID**.
    - ➔ The dialog **Format RFID tag** opens.
  - 3 Place the RFID tag on the RFID reader.
    - ➔ The wizard asks **Do you want to format the RFID tag and delete all data?**
    - ➔ In the dialog, you can read all the stored data.
  - 4 To format the RFID tag, tap → **Format**. To close the dialog, tap ✕ **Cancel**.

### 5.6.3.2 Formatting an RFID Smart Tag using a SmartScan

This example describes how to use a SmartScan to format a Smart Tag, that is, delete all data.

**Note**

This accessory must be installed by a METTLER TOLEDO service technician.

### Formatting a Smart Tag

Navigation: ► Balance menu > Maintenance > Format RFID

- A SmartScan is installed on the balance.
  - A Smart Tag RFID tag is available.
- 1 Navigate to the section **Format RFID**.
  - 2 Tap **Format RFID**.
    - ➔ The dialog **Format RFID tag** opens.
  - 3 Place the RFID tag on the SmartScan weighing pan.
    - ➔ The wizard asks **Do you want to format the RFID tag and delete all data?**
  - 4 To format the RFID tag, tap → **Format**.
    - ➔ The RFID tag is formatted.

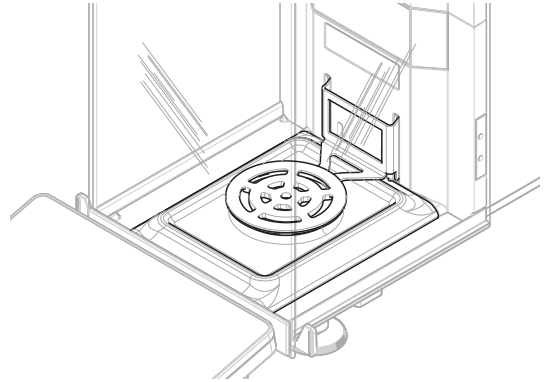

### 5.6.4 Foot switch and ErgoSens

The foot switch and the ErgoSens are optional accessories that allow you to perform operations on your balance without having to use the terminal. The following sections show examples of operations that can be performed with a foot switch or an ErgoSens.



#### NOTICE

##### Damage to the device due to inappropriate use

- Consult the User Manual of the device before using it.

#### 5.6.4.1 Opening the draft shield with a foot switch

This example explains how to install a USB foot switch and use it to open and close the draft shield.

##### Installing and configuring the foot switch

- A foot switch is available.
  - The main weighing screen is shown on the balance terminal.
- 1 Connect the USB cable to one of the USB-A ports of the balance.
    - ➔ The balance detects the USB device automatically. The dialog **Add device** appears, informing the user that the system has found a specific device.
  - 2 Set a name for the USB device, then tap → **Next**.
  - 3 Tap ✓ **Finish**.
    - ➔ The USB device is connected and saved to the system.
    - ➔ The settings of the device are displayed.
  - 4 Tap **Function** and select **Door**.
  - 5 Tap ✓ **Save**.
    - ➔ The foot switch is configured to control the balance door(s).

##### Configuring the balance door(s)

The foot switch can be set to open a single door or several doors of the balance simultaneously, if applicable.

Navigation: ► Balance menu > Settings > Balance > Doors

- 1 Navigate to the section **Doors**.

- 2 For each door that you want to be controlled by the device, select the door and set **Devices** to **Active**.
- 3 Tap **✓ Save**.
  - ➔ The foot switch controls the selected door(s) of the balance.

**See also**

 [Devices / Printers ▶ Page 121](#)

 [Doors ▶ Page 116](#)

### 5.6.4.2 Taring the balance with an ErgoSens

This example explains how to install a USB ErgoSens and configure it to tare the balance.

**Installing and configuring the ErgoSens**

- An ErgoSens is available.
  - The main weighing screen is shown on the balance terminal.
- 1 Connect the USB cable to one of the USB-A ports of the balance.
    - ➔ The balance detects the USB device automatically. The dialog **Add device** appears, informing the user that the system has found a specific device.
  - 2 Set a name for the USB device, then tap **➔ Next**.
  - 3 Tap **✓ Finish**.
    - ➔ The USB device is connected and saved to the system.
    - ➔ The settings of the device are displayed.
  - 4 Tap **Function** and select **Tare**.
  - 5 Tap **✓ Save**.
    - ➔ The ErgoSens is ready to use to tare the balance.

**See also**

 [Devices / Printers ▶ Page 121](#)

### 5.6.5 Pump

When dosing liquid with the **Q3 dosing module** or the **QLX3 liquid module**, a **QL3 pump** must be connected to the balance.



**NOTICE**

**Damage to the device due to inappropriate use**

- Consult the User Manual of the device before using it.

- A QL3 pump is available.
  - The pump is connected to the power supply.
  - A USB-A to USB-B cable is available.
  - The main weighing screen is shown on the balance terminal.
- 1 Connect the USB cable to the USB-B port of the pump.
  - 2 Connect the USB cable to a USB-A port on the balance.
    - ➔ The balance detects the USB device automatically. The dialog **Add device** appears, informing the user that the system has found a specific device.
  - 3 Set a name for the USB device, then tap **➔ Next**.
  - 4 Tap **✓ Finish**.
    - ➔ The USB device is connected and saved to the system.

- ➔ The settings of the device are displayed.
- 5 Tap **✓ Save**.
    - ➔ The pump is installed and ready to be used.

**Note**

The adequate pump pressure for dosing depends on the liquid and the type of dosing head. It can be specified individually for each dosing head, see [Managing the dosing head data ▶ Page 99].

**See also**

 [Devices / Printers ▶ Page 121](#)

## 5.6.6 Editing the settings of a device

**Navigation:** ▶ **Balance menu** > **Settings** > **Devices / Printers**

- 1 Navigate to the section **Devices / Printers**.
  - ➔ A list of devices appears, showing the connection status and the connection type of each device.
- 2 Select the device from the list of devices and printers.
  - ➔ The details of the device are shown.
- 3 To change the name of the device, tap **Name**, enter the name and tap **✓**.
- 4 Some devices have additional editable settings. Tap on those settings to edit them.
- 5 Save the settings.

## 5.6.7 Deleting a device

**Navigation:** ▶ **Balance menu** > **Settings** > **Devices / Printers**

- 1 Navigate to the section **Devices / Printers**.
  - ➔ A list of devices appears, showing the connection status and the connection type of each device.
- 2 Select the device from the list of devices and printers.
- 3 Tap **Delete device**.
  - ➔ A message appears, asking you to confirm that you want to delete the device.
- 4 To delete, tap **✓ OK**. To cancel the delete dialog, tap **✗ Cancel**.
  - ➔ The device is deleted.

## 5.7 Remote control via services

### 5.7.1 LabX service

To enable communication between LabX and instruments, the appropriate settings on the instruments must correspond with the settings in LabX. LabX synchronizes the date and time on the instruments with the LabX Server each time a connection is made and each time a task is started. When an instrument is connected, the user interface language on the connected instrument is changed to the language currently installed on the LabX installation.



To install LabX on your computer and for more information about LabX, consult the LabX Reference Manual (RM).

**Note**

Once the connection between LabX and the balance is established, the balance terminal is controlled by LabX. It is always possible to switch to manual mode directly on the terminal.

## See also

 [LabX / Services](#) ▶ Page 123

### 5.7.1.1 Using LabX via a USB connection

To establish this connection, the USB driver must be installed on your computer. The driver is available online:

▶ [www.mt.com/labweighing-software-download](http://www.mt.com/labweighing-software-download)



#### Connecting the balance to the computer

- A USB-A to USB-B cable is available.

  - 1 Connect the USB cable to the USB-B port of the balance.
  - 2 Connect the USB cable to a USB-A port on the computer.

#### Configuring the service on the balance

≡ **Navigation:** ▶ **Balance menu** >  **Settings** >  **LabX / Services**



- 1 Navigate to the section  **LabX / Services**.
- 2 Set **LabX service** to **USB**.
- 3 Tap  **Save**.

### 5.7.1.2 Using LabX via an Ethernet connection

#### Connecting the balance to the network

≡ **Navigation:** ▶ **Balance menu** >  **Settings** >  **Interfaces**



- An Ethernet cable is available.

  - 1 Connect the Ethernet cable to the Ethernet port of the balance.
  - 2 Connect the other end of the Ethernet cable to your local network.
  - 3 Navigate to the section  **Interfaces**.
  - 4 Tap **Ethernet**.
  - 5 Keep the settings of the Ethernet connection at hand. This information might be required to set up the connection at a later stage.
  - 6 Tap  **Save**.

#### Configuring the service on the balance

≡ **Navigation:** ▶ **Balance menu** >  **Settings** >  **LabX / Services**

- The balance is connected to the network via Ethernet.

  - 1 Navigate to the section  **LabX / Services**.
  - 2 Set **LabX service** to **Network**.
  - 3 Note the port number. This information might be required to set up the connection at a later stage.
  - 4 Tap  **Save**.

## 5.7.2 MT-SICS service

All XPR balances can be integrated to a network and can be configured to communicate with a computer using MT-SICS (METTLER TOLEDO Standard Interface Command Set). The available commands depend on the functionality of the balance.

For further information, please contact your METTLER TOLEDO representative.

The full documentation related to MT-SICS for XPR and XPR Essential balances is available online.

▶ [www.mt.com/labweighing-software-download](http://www.mt.com/labweighing-software-download)



## See also

 LabX / Services ▶ Page 123

### 5.7.2.1 Using MT-SICS via a USB connection

This example describes how to establish a direct USB connection between your balance and a computer. The computer can then be used to control the balance and receive data using the commands of MT-SICS.

To establish this connection, the USB driver must be installed on your computer. The driver is available online:

▶ [www.mt.com/labweighing-software-download](http://www.mt.com/labweighing-software-download)

#### Connecting the balance to the computer

- A USB-A to USB-B cable is available.

  - 1 Connect the USB cable to the USB-B port of the balance.
  - 2 Connect the USB cable to a USB-A port on the computer.

#### Configuring the service on the balance

≡ **Navigation:** ▶ **Balance menu** >  **Settings** >  **LabX / Services**

- 1 Navigate to the section  **LabX / Services**.
- 2 Set **MT-SICS** to **USB**.
- 3 Tap  **Save**.

#### Configuring the computer

- The USB driver is installed on the computer.
- A terminal program is installed and running on the computer.

  - 1 Provide the necessary connection settings to the terminal program.
  - 2 Test the connection by sending a command to the balance, for example, `s` to retrieve the stable weight from the balance.
    - ➔ If a string is received by the terminal program with the weight, date, and time, the connection has been successfully established.
    - ➔ If no response is received by the terminal program, check the connection settings.



### 5.7.2.2 Using MT-SICS via an Ethernet connection

This example describes how to establish a connection between a balance and a computer through a local network. The computer can then be used to controlled the balance and receive data using the commands of MT-SICS.

#### Connecting the balance to the network

≡ **Navigation:** ▶ **Balance menu** >  **Settings** >  **Interfaces**

- An Ethernet cable is available.

  - 1 Connect the Ethernet cable to the Ethernet port of the balance.
  - 2 Connect the other end of the Ethernet cable to your local network.
  - 3 Navigate to the section  **Interfaces**.
  - 4 Tap **Ethernet**.
  - 5 Keep the settings of the Ethernet connection at hand. This information might be required to set up the connection at a later stage.
  - 6 Tap  **Save**.

### Configuring the service on the balance

≡ **Navigation:** ▶ **Balance menu** > ⚙️ **Settings** > 🏠 **LabX / Services**

- The balance is connected to the network via Ethernet.
- 1 Navigate to the section 🏠 **LabX / Services**.
- 2 Set **MT-SICS** to **Network**.
  - ➔ The port number appears in the list of settings.
- 3 Note the port number. This information might be required to set up the connection at a later stage.
- 4 Tap ✓ **Save**.

### Configuring the computer

- A terminal program is installed and running on the computer.
- 1 Provide the necessary connection settings to the terminal program.
  - ➔ The computer is connected to the same network and the same subnet as the balance.
- 2 Test the connection by sending a command to the balance, for example, `s` to retrieve the stable weight from the balance.
  - ➔ If a string is received by the terminal program with the weight, date, and time, the connection has been successfully established.
  - ➔ If no response is received by the terminal program, check the connection settings.

#### i **Note**

For more information, contact your network administrator.

## 5.7.3 Web service

The web service allows users to send commands to control and transfer data from the balance using a web browser.

### Connecting the balance to the network

≡ **Navigation:** ▶ **Balance menu** > ⚙️ **Settings** > 🏠 **Interfaces**

- An Ethernet cable is available.
- 1 Connect the Ethernet cable to the Ethernet port of the balance.
- 2 Connect the other end of the Ethernet cable to your local network.
- 3 Navigate to the section 🏠 **Interfaces**.
- 4 Tap **Ethernet**.
- 5 Keep the settings of the Ethernet connection at hand. This information might be required to set up the connection at a later stage.
- 6 Tap ✓ **Save**.

### Configuring the service on the balance

≡ **Navigation:** ▶ **Balance menu** > ⚙️ **Settings** > 🏠 **LabX / Services**

- The balance is connected to the network via Ethernet.
- The computer and the balance are connected to the same network.
- A web browser is available on the balance.
- 1 Navigate to the section 🏠 **LabX / Services**.
- 2 Activate and configure the service.
- 3 Tap ✓ **Save**.



The documentation of web service and related examples are available online.

[www.mt.com/labweighing-software-download](http://www.mt.com/labweighing-software-download)

#### **Note**

For more information, contact your network administrator.

#### **Exporting the WSDL definition file**

The WSDL (Web Services Description Language) file describes the functionalities of the web service. The WSDL file can be exported as follows.

☰ **Navigation:** ▶ **Balance menu** > ⚙ **Settings** > 📁 **Balance** > ⚙ **General**

- 1 Navigate to ⚙ **General**.
- 2 Tap **⋮ More**.
- 3 Tap **Export web service WSDL file**
  - ➔ A list of available target locations is shown, including the file server and any USB storage device connected to the balance.
- 4 Select the target device on which you want to store the data.
- 5 Tap **→ Next**.
  - ➔ If the export was successful, the display shows  with the name of the file and the target folder.

#### **See also**

 [LabX / Services](#) ▶ Page 123

## **5.8 Data management**

### **5.8.1 Exporting results**

This example describes how to export results to a file server at the end of a task. A similar exporting procedure can be followed when using a USB storage device.

#### **Connecting to a file server**

☰ **Navigation:** ▶ **Balance menu** > ⚙ **Settings** > 📁 **LabX / Services**

- 1 Navigate to the section 📁 **LabX / Services**.
- 2 Set **File server** to **Active**.
- 3 Tap **File server configuration**.
- 4 Tap **Server name** and type the name of your server.
- 5 Tap **Share name** and type the path of the shared folder that you want to use.
- 6 Tap **Credentials** in the action bar.
  - ➔ The dialog **Set file server credentials** appears.
- 7 Fill in your credentials (**Domain name**, **User name**, and **Password**) and tap **✓ OK**.
  - ➔ The credentials are saved on the balance.
- 8 Tap **✓ OK** to establish the connection to the file server.

#### **Exporting the XSD file**

Weighing results are exported in XML files. The description of the elements of the XML file is provided in an XSD (XML Schema Definition) file. The XSD file can be exported as follows.

#### **Note**

If the XSD file is used for validation, the version contained in the XML file must match the version of the XSD schema.

☰ **Navigation:** ▶ **Balance menu** > ⚙️ **Settings** > 📊 **Balance** > ⚙️ **General**

- 1 Navigate to ⚙️ **General**.
- 2 Tap ⋮ **More**.
- 3 Tap **Export results XSD files**.
  - ➔ A list of available target locations is shown, including the file server and any USB storage device connected to the balance.
- 4 Select the target device on which you want to store the data.
- 5 Tap → **Next**.
  - ➔ If the export was successful, the display shows ✔️ with the name of the target folder.

### Exporting weighing results

☰ **Navigation:** ▼ **Methods** > 📄 **Methods list**

- An Ethernet connection is established.
  - A file server access is configured.
- 1 Select a method from the **Methods list**.
  - 2 Tap ▶ **Start method**.
  - 3 Perform the necessary actions to weigh your sample(s).
  - 4 Tap 📄 **Complete** to open the export options.
    - ➔ The dialog **Complete task** appears.
  - 5 Tap **Export results manually** to export the results.
    - ➔ A list of available target locations is shown, including the file server and any USB storage device connected to the balance.
  - 6 Select **File server**.
  - 7 Tap → **Next**.
    - ➔ The system checks the credentials for the file server connection.
    - ➔ The results are exported to the file server.
  - 8 Tap ✔️ **Complete**.
    - ➔ After completing the task, the results are deleted from the **Results list**.

### See also

🔗 [LabX / Services](#) ▶ Page 123

## 5.8.2 Sending individual results to a computer

The balance offers the possibility to send weighing results to a computer via a USB connection. This feature can be used, for example, to send results to an Excel sheet, to a text file, or to MT-SICS. When used in mode **HID** (Human Interaction Device), the result is sent to the computer where the cursor is located, exactly as if it were a keyboard input (also referred to as "drop to cursor").

This example describes how to send weighing results from a method of type **General weighing** directly into an Excel file on a computer using the functionality **HID**.

### Connecting the balance to the computer

- A USB-A to USB-B cable is available.
- 1 Connect the USB cable to the USB-B port of the balance.
  - 2 Connect the USB cable to a USB-A port on the computer.

### Configuring the balance

☰ **Navigation:** ▶ **Balance menu** > ⚙️ **Settings** > 📊 **Balance** > ⚙️ **Weighing / Quality**

- 1 Navigate to the section ⚙️ **Weighing / Quality**.

- 2 Tap **Automatic weight value output**.
- 3 Tap **Output mode** and select **Results**.
- 4 Tap **Target** and select **HID**.
- 5 Review the rest of the settings in the section **Automatic weight value output** to customize the output, for example, to add the date and time to each weighing result.

**Note**

The right settings are highly dependent on your application. For example, when using an Excel sheet as the target, values separated with the character **TAB** will be placed in separate cells.

### Editing the method settings

Navigation: ▼ **Methods** > ☰ **Methods list**

- A method **General weighing** exists.
- 1 Select the method from the **Methods list**.
  - 2 Tap ✎ **Edit**.
  - 3 Tap 🖨 **Print / Export**.
  - 4 Tap **Strip printout and data export**.
  - 5 Set **Weight value** to **Active**.
  - 6 Tap ✓ **OK**.
  - 7 Tap ✓ **Save**.
    - ➔ The method is set up to send the results to the computer when tapping **Add result**.

### Running the method

- The USB driver is installed on the computer.
- 1 Select the method from the **Methods list**.
  - 2 Tap ▶ **Start method**.
  - 3 Perform the necessary actions to weigh your sample.
  - 4 Open an Excel sheet and place the cursor in a first target cell, for example, "A1".
  - 5 Tap + **Add result**.
    - ➔ The weighing result is saved to the **Results list**.
    - ➔ The weighing result is stored in cell "A1" of your Excel sheet.
    - ➔ If the character **TAB** is used as delimiter, the other weighing parameters are stored in cells "B1", "C1", etc.
    - ➔ If the character **Enter** is used to mark the end of the line, the cursor now appears in cell "A2".

## 5.8.3 Exporting and importing settings

The settings of the balance can be exported and imported. Transferring data from one balance to another is helpful, for example, to use the same method on several balances. It is also good practice to store the balance settings as backup before updating the software.

The following data can be imported and exported:

- **Balance settings**
  - When importing these settings, the GWP status of the balance might change (**GWP Approved mode**).
  - The balance might prompt to reboot.
- **User management**
  - When importing these settings, the existing settings on the balance are replaced.
- **Methods**
  - When importing methods, you can select if all methods or only selected methods are imported.
  - If importing a method with the same name as an existing method, you can select if you want the method to be overwritten or not.

- **Tests and weights**

- When importing these settings, all the existing tests and test weights on the balance are erased and replaced by the imported data.

The data can be transferred via a USB storage device. For XPR balances, the data can also be transferred via a file server.



## NOTICE

### Data import can cause data loss



Importing data can delete user application data without warning.

### 5.8.3.1 Transferring test weight settings between balances

This example shows how to export test weight settings from one balance and import them on another balance. This procedure is particularly helpful if you are using the same calibrated weights to perform tests on several balances. The data is transferred using a USB storage device.



#### Exporting data and settings

≡ **Navigation:** ▶ **Balance menu** >  **Maintenance** >  **Import / Export**

- A USB storage device is connected to the balance.
- 1 Navigate to the section  **Import / Export**.
  - ➔ The dialog **Import / Export** opens.
- 2 Select  **Export data and settings** and tap → **Next**.
  - ➔ The dialog **Export data and settings** opens.
- 3 Deactivate all data types except **Tests and weights**.
- 4 Tap ✓ **Export**.
  - ➔ A list of available USB storage devices is shown.
- 5 Select the target USB storage device to store the data.
- 6 Tap → **Next**.
  - ➔ The system exports the data to the USB storage device.
  - ➔ If the export was successful, the display shows 🟢 with the name of the file and the target folder.
- 7 Tap ✕ **Close** to finish the process.

#### Importing data and settings

≡ **Navigation:** ▶ **Balance menu** >  **Maintenance** >  **Import / Export**

- A USB storage device containing the data to import is connected to the balance.
- 1 Navigate to the section  **Import / Export**.
  - ➔ The dialog **Import / Export** opens.
- 2 Select  **Import data and settings** and tap → **Next**.
  - ➔ A list of available USB storage devices is shown.
- 3 Select the USB storage device containing the data to import.
- 4 Tap → **Next**.
- 5 Select which file you want to import.
- 6 Tap → **Next**.
- 7 To import only the test weights, select the data type **Test weights**.
- 8 Tap ✓ **Import**.
  - ➔ The system imports the data from the USB storage device.
  - ➔ If the import was successful, the message **Import of data and settings has been executed.** appears.

9 Tap **X Close** to finish the process.

## 5.9 User management



### NOTICE

#### Loss of data due to missing password or User name

Protected menu areas cannot be accessed without **User name** or password.

- Note **User name** and password and keep them in a safe place.

### 5.9.1 Activating the user management

≡ **Navigation:** ▶ **Balance menu** > ⚙️ **Settings** > ⚙️ > **Balance** > ⚙️ **General** > **User management**

The user management is disabled in the factory settings. To activate the user management follow:

- 1 Tap **:** and select **Active**.
  - ➔ The dialog **Activate user management** opens.
- 2 Tap **→ Next**.
  - ➔ The dialog **Set administrator password (optional)** opens.
- 3 Tap **New password** and enter the new password.
- 4 Confirm the new password again and tap **✓ OK**.
  - ➔ The dialog closes.
- 5 Confirm the activated user management in the section **General**, tap **✓ OK**.
  - ➔ The **User management** is active. The login dialog opens at every system start.

### 5.9.2 Disabling the user management

≡ **Navigation:** ▶ **Balance menu** > ⚙️ **Settings** > ⚙️ > **Balance** > ⚙️ **General** > **User management**

- 1 Tap **:** and select **Inactive**.
  - ➔ The dialog **Deactivate user management** opens.
- 2 Tap **→ Next**.
  - ➔ The dialog **Set unblocking password** opens.
- 3 Tap **New password** and enter the new password.
- 4 Confirm the new password again and tap **✓**.
  - ➔ The dialog closes.
- 5 Tap **✓ OK** to confirm.
  - ➔ The user management is inactive.

### 5.9.3 Managing users and user groups

The **Users** settings are only visible when the **User management** is set to **Active**.

≡ **Navigation:** ▶ **Balance menu** > 👤 **Users**

#### Printing user list

An overview of all users and user groups can be printed by tapping  **Print all**.

#### See also

 [Activating the user management](#) ▶ Page 93

### 5.9.3.1 Creating a new user

≡ **Navigation:** ▶ **Balance menu** > 👤 **Users** > 👤 **Users**

- 1 Tap **+ New user** in the action bar.
- 2 Define the values for the new user.
- 3 To define a user profile password, tap **🔑 Change password** in the action bar.
- 4 Tap **New password**.
  - ➔ The keyboard dialogue opens.
- 5 Define the password.
- 6 Tap **Confirm new password** and fill in the defined password.
- 7 Tap **✓** to close the keyboard dialogue.
- 8 Tap **✓ OK** to confirm the defined password.
  - ➔ The dialogue **User name** opens.
- 9 Tap **✓ OK** to confirm the defined user profile.
  - ➔ The user has been created. The new user profile appears in the list.

### 5.9.3.2 Creating a new group

≡ **Navigation:** ▶ **Balance menu** > 👤 **Users** > 👤 **Groups**

#### **Note**

This area is only accessible for users with the appropriate rights.

- 1 Tap **+ New group**.
  - ➔ The dialog opens.
- 2 Define the group properties.
- 3 Tap **✓ OK**.
  - ➔ The group has been created, the system returns to the list of defined groups.

### 5.9.3.3 Deleting users or user groups

Requirements for deleting:

- You logged in as administrator.

≡ **Navigation:** ▶ **Balance menu** > 👤 **Users** > 👤 **Users**

- 1 Select the **User name** of the user to delete.
  - ➔ The user management dialog opens.
- 2 Tap **🗑 Delete** in the action bar.
  - ➔ The dialog **Delete user** opens.
- 3 To delete the user tap **✓ OK**.
  - ➔ The user is deleted irreversibly.

## 5.10 Tolerance profiles

≡ **Navigation:** ▶ **Balance menu** > ⚙ **Settings** > ⚖ **Balance** > ⚖ **Weighing / Quality** > **Tolerance profiles**

### Creating a Tolerance profile

- 1 Tap **+ New** to create a new profile.
- 2 Define the profile settings.
- 3 When all the settings have been defined, tap **✓ OK**.
  - ➔ The system returns to the profile list and the new profile appears on the list.



By tapping an existing profile, its settings can be changed, the profile can be deleted or it can be set as default value. Several profiles can be created. A default profile must be selected.

If changes are made to the default tolerance profile, the status of the routine tests will be set to **Never executed**.

## 5.11 Password protection and balance reset

### 5.11.1 Password protection

If user management is active, each user has an individual password.

- Any logged in user can change his own password. See [Changing a password ▶ Page 95].
- Users with permission to configure user management can change the password of any user. See [Changing a password ▶ Page 95].
- If a user with permission to configure user management has forgotten his password (and no other user can change it), a password reset can be requested. See [Requesting a reset password ▶ Page 95]

#### **Note**



If the parameter **Password reset** is set to **Not allowed**, the balance needs to be reset by a service technician.

If user management is inactive, a password can be generated to block the whole balance. See [Creating an unblocking password ▶ Page 96].

#### 5.11.1.1 Changing a password



Any user can change its own password. Additionally, users with permission to configure user management can change the password of other users.

≡ **Navigation:** ▶ **Balance menu** >  **Users** >  **Users**

- 1 Select the **User name** for which the password should be changed.
  - ➔ The user management dialog opens.
- 2 Tap  **Change password** in the action bar.
  - ➔ The dialog **Change password** opens.
- 3 Enter a new password and confirm it.
  -  **Note**  
Any password is valid.
- 4 Tap  **OK**.
  - ➔ The password has been changed.

#### 5.11.1.2 Requesting a reset password

If a user with the permission to configure user management has forgotten his password, a reset password can be requested.

- The balance login dialog is open.
- 1 Select the user who needs a password reset. That user needs to have the permission to configure user management.
  - 2 Tap **⋮ More**.
    - ➔ The dialog **More** opens.
  - 3 Tap  **Request reset password**.
  - 4 The dialog **Request reset password** opens.
  - 5 Note the service code and tap  **Service request**.
    - ➔ Information about your METTLER TOLEDO service representative appears.
  - 6 Contact your METTLER TOLEDO service representative via phone or email.
    - ➔ You get an 8-character reset password with which you can log in once.
  - 7 Log in with your reset password and select a new password.

### 5.11.1.3 Creating an unblocking password

If the user management is inactive, the balance can still be blocked with a unique password, called the unblocking password. This password first need to be generated and needs to be provided to block and unblock the balance.

≡ **Navigation:** ▶ **Balance menu** > ⚙️ **Settings** > ⚖️ **Balance** > ⚙️ **General**

- 1 To create an unblocking password, tap 🔑 **Unblocking password** in the action bar.
  - ➔ The dialog **Set unblocking password** opens.
- 2 Set a new password, confirm it, and tap ✓ **OK**.
- 3 In the dialog ⚙️ **General**, tap ✓ **Save** and ✓ **OK**.
  - ➔ The unblocking password is created.

### 5.11.2 Logging in and logging out

If the user management is active, users need to log in to use the balance.

#### 5.11.2.1 Logging in

- The balance login dialog is open.
- 1 Select a user and enter the password.
  - 2 Tap ↪️ **Login**.
    - ➔ You are logged in and your user name is displayed on the main weighing screen.

#### 5.11.2.2 Logging out

**Navigation:** ▶ **Balance menu** > ⏸️ **Exit/ Block balance**

- Tap ⏸️ **Logout**.
  - ➔ You are logged out.

### 5.11.3 Blocking and unblocking the balance

A blocking means closedown of the balance. A reason for such "full blocking" can have a serious background. If the balance has a defect or a loss of the weighing quality, the user can block the balance completely.

If user management is active, users can block the balance if they have the related permission.

If user management is inactive, the balance can still be blocked to prevent any further usage of the balance. If no unblocking password has been set, the balance can get blocked and unblocked without a password. If an unblocking password has been set, the balance can only get blocked and unblocked using this password. See [Creating an unblocking password ▶ Page 96].

#### 5.11.3.1 Blocking the balance

≡ **Navigation:** ▶ **Balance menu** > ⏸️ **Blocking**

- 1 To block the balance, tap 🔒 **Block balance**.
  - ➔ The dialog **Block balance** opens.
- 2 Tap → **Next**.
- 3 Enter your unblocking password and tap ✓ **Block balance**.
  - ➔ The balance is blocked and the blocking screen appears.

#### 5.11.3.2 Unblocking the balance

- The balance is blocked and the blocking screen is open.
- 1 Tap 🔓 **Unblock balance**.
  - 2 Type in the unblocking password, if applicable.

- 3 Tap **✓ Unblock balance** to confirm.  
By tapping **✗ Cancel** instead, the main weighing screen appears, but the balance is still blocked and only a limited number of settings can be edited.
- ➔ The balance is unblocked and the main weighing screen appears.

### 5.11.4 Resetting the balance

When user management is active, only users with the appropriate permissions can reset the balance.

☰ **Navigation:** ▶ **Balance menu** >  **Maintenance** >  **Reset**



#### NOTICE

##### Reset causes data loss

Resetting the balance will delete user application data and set the user configuration back to factory state.

- 1 To delete the change history data and the data for test history and adjustment history, activate the option **Also delete change, test and adjustment history**.
- 2 Tap **→ Next**.
  - ➔ The window **Reset balance** opens and warns that some data will be lost by resetting the balance.
- 3 Tap **↶ Reset balance**.
  - ➔ The balance software restarts in factory state. The alibi memory settings and alibi entries remain unchanged.

## 5.12 Automated dosing

### 5.12.1 Setting the height of the dosing head

This section refers to operations available for the **Q3 dosing module**.

When using a **QLX3 liquid module**, the height of the liquid module is set manually. Refer to the Reference Manual (RM) of your QLX3 liquid module for more details.

When dosing with the Q3 dosing module, the height of the dosing head can be specified as a setting in the method or while running the method. When the dosing position is specified while running the method, it is not saved in the method settings and must be adjusted each time the method is started.

The **Dosing position** can be determined automatically using an integrated optical sensor and the feature **HeightDetect**. Alternatively, it can be set manually as an absolute position. Both options are described in details in the following sections.

The dosing head can move down to a distance of 75 mm from the weighing pan. If the opening of the sample vessel is lower than that, consider using a different ErgoClip.



For further information about how to choose the appropriate ErgoClip for dosing, consult the Reference Manual (RM) of your Q3 dosing module.

▶ [www.mt.com/Q3-RM](http://www.mt.com/Q3-RM)

#### **Note**

Before the dosing head moves up and down, the doors open by 10% to avoid pressure variations in the weighing chamber. The doors close automatically once the dosing head stops moving.

#### 5.12.1.1 Definition of the dosing head positions

- **Home position:** Uppermost position of the dosing head. When in **Home position**, the dosing head is automatically unlocked and can be removed.
- **Dosing position:** Position of the dosing head used while dosing.

- **Safe position:** Position above the **Dosing position** used to ensure that the dosing head is not in contact with the sample vessel. The **Safe position** is about 15 mm above the **Dosing position** and it is used, for example, during taring and weight capture.

**Note:** For liquid dosing with **HeightDetect**, the **Safe position** is used for dosing.

### 5.12.1.2 HeightDetect

The Q3 dosing module is equipped with an optical sensor that allows to automatically detect the height of the opening of most sample vessels (**HeightDetect**). When **HeightDetect** is performed, an additional fine adjustment of the **Dosing position** can be applied manually. The dosing head returns to the **Safe position** for taring, weight capture, etc.

If the value of the **Fine adjustment** is saved in the method settings, each new dosing will start with a detection of the vessel opening. Then, the dosing head will move up or down by the value saved as **Fine adjustment**. For example, the **Fine adjustment** can be set up to bring the tip of the dosing head closer to the vial opening. This is particularly useful if you have several sample vessels with various heights, but with a similar opening geometry, and you want to dose very close to the vessel opening.

As described above, the method can be set up to use the optical detection of the vessel opening, **HeightDetect**, for each dosing. However, **HeightDetect** can also be used to help set up the absolute **Dosing position**, see [Absolute Dosing position ▶ Page 98].

If the optical sensor does not detect the vial opening, see [Troubleshooting ▶ Page 221].



Button	Name	Description
↑ ↓	–	Use these buttons to move the dosing head up and down in small steps.





The wizard shows in green the distance from the detected vial opening.

### 5.12.1.3 Absolute Dosing position

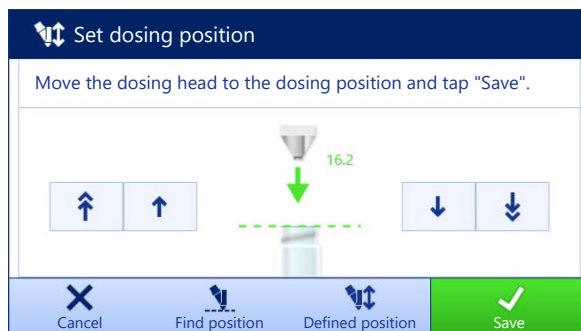
The **Dosing position** can also be set manually as an absolute position. In this case, the use of the **Safe position** is optional and must be activated/disabled in the method settings.

If the absolute **Dosing position** is saved in the method settings, each new dosing will be performed at this position.



Button	Name	Description
	<b>Find position</b>	Use this button to have the dosing lift automatically detect the height of the vessel opening using the optical sensor.
	<b>Defined position</b>	Use this button to move the dosing head to the previously defined <b>Dosing position</b> . This button is only available when an absolute <b>Dosing position</b> has already been defined.
	–	Use these buttons to move the dosing head up and down in large steps.
	–	Use these buttons to move the dosing head up and down in small steps.

The wizard shows in green the distance from the **Home position**.

### 5.12.2 Managing the dosing head data



Each dosing head includes an RFID tag that can exchange data with the instrument. You can remove the dosing head and insert it into another dosing module or liquid module, where the data is immediately available.

#### **Note**

The data on the RFID tag of the dosing head can also be managed by any XPR balance equipped by an external RFID reader.

☰ **Navigation:** ▼ **Methods** >  **Manual operations** >  **Manage dosing head data**



#### **Editing the dosing head data**

- 1 Tap  **Manage dosing head data**.
  - ➔ The dialog box opens in which the dosing head data is displayed.
- 2 Tap  **Edit** to edit the data of the attached dosing head.
- 3 Tap  **OK** to save the data.

#### **Copying the dosing head data**

The data stored on a dosing head can be copied to another dosing head with this function. Re-entering all the required data on a new dosing head with the same or similar substances is not necessary.

- A first dosing head, from which data will be copied, is attached to the dosing or liquid module.
- A second dosing head, on which the data will be saved, is available.

- 1 Tap  **Manage dosing head data**.
  - ➔ The dialog box opens in which the dosing head data is displayed.
- 2 Tap  **Copy** to copy the data of the attached dosing head.
- 3 Follow the instructions from the wizard.

#### **Available fields for dosing head data**

Depending on the type of dosing head, the following data is stored on the RFID tag.

Parameter	Description	Values
Substance	Specifies the name of the substance.	Text (0...20 characters)
Lot ID	Defines the batch identification.	Text (1...15 characters)
Verify expiry date before dosing	Defines whether the expiry date is verified before dosing.	Active   Inactive*
Expiry date	Specifies the expiry date of the substance.	Date
Set the filling date	Defines whether the filling date must be specified.	Active   Inactive*

Filling date	Specifies the date when the dosing head was filled.	Date
ID 1 field label... ID 3 field label	Defines the label of the user-defined fields.	Text (0...10 characters)
ID 1 value...ID 3 value	Defines the values of the user-defined fields.	Text (0...15 characters)
Molar mass	Defines the molar mass of the substance.	Numeric (1...10000 g/mol)
Purity	Defines the purity of the substance.	Numeric (0.001...100%)
Density	Defines the liquid density. This field is only available for liquid dosing heads.	Numeric (1 g/ml*   0.01...10 g/ml)
Verify quantity before dosing	Defines whether the remaining quantity in the dosing head is verified before dosing.	Active   Inactive*
Remaining quantity	Residual quantity of substance in the dosing head. When filling the dosing head, insert the weight of the substance in this field. To use the weight on the weighing pan, tap  .	Numeric (0.01...999999 mg)
Verify dose limit before dosing	Defines whether the dose limit of the dosing head is verified before dosing. This field is only available for powder dosing heads.	Active*   Inactive
Remaining doses	Shows the number of dosing operations still available with this dosing head, before reaching the <b>Dose limit</b> . The <b>Remaining doses</b> is calculated based on the <b>Dose limit</b> and the <b>Number of total dosages</b> . This field is only available for powder dosing heads. It is only available when <b>Verify dose limit before dosing</b> is set to <b>Active</b>	Numeric
Dose limit	Specifies the maximum number of dosing operations with this dosing head. This field is only available for powder dosing heads.	Numeric (250*   0...50000)
Number of total dosages	Shows the number of dosing operations performed with this dosing head until now. This field is only available for powder dosing heads. It is only available when <b>Verify dose limit before dosing</b> is set to <b>Active</b> .	Numeric
Tapping while dosing	Activates the automatic start of the tapper during dosing. Note that tapping can lead to compacting effects with some powders. This field is only available for powder dosing heads.	Active*   Inactive
Tapping before dosing	Activates the automatic start of the tapper before each dosing. Note that tapping can lead to compacting effects with some powders. This field is only available for powder dosing heads.	Active   Inactive*
Pump pressure	Defines the pump pressure for the liquid dosing operation. This field is only available for liquid dosing heads.	0.3   0.4   0.5 bar*
Dosing head type	Shows the type of the dosing head.	Text
Dosing head ID	Shows the unique ID of the dosing head.	Text



\* Factory setting

### 5.12.3 Changing the pump pressure

The pump pressure can be adjusted, depending on the liquid and dosing head used. The pump pressure is saved as a setting on the dosing head, see [Managing the dosing head data ► Page 99].

## 5.12.4 Purging a liquid dosing head

This section refers to operations available for the **Q3 dosing module** and **QLX3 liquid module**.

- A method **Automated dosing** or **Automated solution prep.** is running on the terminal.
  - A QL3 pump is connected to the balance.
  - A bottle with the required solvent and liquid dosing head is attached to the pump.
  - A dosing head is attached to the dosing or liquid module.
  - A big sample vessel is on the weighing pan to collect the solvent used to purge the dosing head.
- 1 In the action bar, tap , **Purge head**.
  - 2 Set a **Purge duration**.
  - 3 Tap .
    - ➔ Liquid flows through the liquid dosing head until the **Purge duration** is reached.

## 5.12.5 Controlling the position of the sample changer

This section refers to operations available for the **QS3 sample changer**.

### Principle of operation

After each movement step, the sample changer turns the rack back slightly. This ensures that the adapter and sample vessel stand freely on the weighing pan in the weighing/dosing position.

### Moving to a specific position

Use the function  **Sample changer control** to move the drive ring to a specific position. The sample changer can move one position at a time or one rack at a time (five positions).





### NOTICE

#### Damage to the instrument

The pin under the weighing pan cover and the weighing basket is inserted in the weighing pan during use. If the drive ring moves while the weighing pan cover or the weighing basket is installed, the sample changer or the balance can get damaged.

- 1 Remove the weighing pan cover or the weighing basket as soon as the weighing, test, or adjustment is complete.
- 2 Always check that the **Home position** cover is in place before moving the sample changer's position.

- A method **Automated dosing** or **Automated solution prep.** is running on the terminal.
- 1 Tap  **Sample Changer**.
    - ➔ The corresponding dialog box opens.
  - 2 Select the required operations.
  - 3 Tap  **OK** to close the dialog.

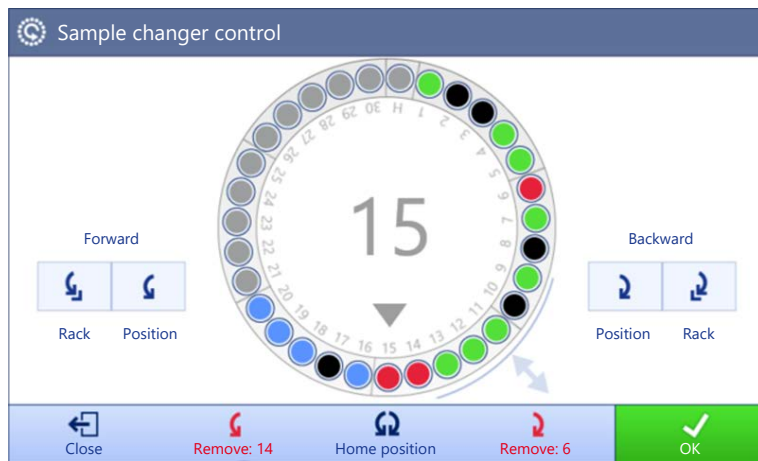



Button	Name	Description
	<b>Home position</b>	The sample changer moves the <b>Home position</b> on top of the weighing pan. While in <b>Home position</b> , the weighing pan cover or weighing basket can be installed on the weighing pan to perform a simple weighing, adjustment, or test. Always place back the <b>Home position</b> cover before moving the sample changer's position.
	<b>Forward / Position</b>	The sample changer moves the drive ring one position forward.
	<b>Backward / Position</b>	The sample changer moves the drive ring one position backward.
	<b>Next / Rack</b>	The sample changer moves the drive ring five numbered positions forward, to the next rack.
	<b>Backward / Rack</b>	The sample changer moves the drive ring five numbered positions backward, to the previous rack.
	<b>Remove</b>	The sample changer moves the drive ring forward until the specified position is at the tunnel opening and the sample vessel can be removed.
	<b>Remove</b>	The sample changer moves the drive ring backward until the specified position is at the tunnel opening and the sample vessel can be removed.

### Results state

On the display, each position of the sample changer is color coded according to the status of the weighing results:

Icon	Result state	Description
	–	No measurement was performed.
	<b>OK</b>	The result fulfills a set of criteria.
	<b>Not OK</b>	The results criteria are not fulfilled, for example, the result is out of the defined tolerances.



Icon	Result state	Description
	<b>Excluded</b>	The sample is excluded from the <b>Results list</b> .
	<b>OK</b>	The first component of the solution has status <b>OK</b> , but the second component is not yet added. This status is only relevant for the methods <b>Automated solution prep.</b> and <b>Automated solution prep. (itemized)</b> .

## 5.12.6 Adjusting the sample changer

This section refers to operations available for the **QS3 sample changer**.

### Adjusting the alignment – front to back



The alignment of the sample changer (front to back) is adjusted by the METTLER TOLEDO technician during installation.

### Adjusting the alignment – left to right

The lateral alignment of the sample changer is adjusted by the METTLER TOLEDO technician during installation. If necessary, the alignment can be corrected, in particular when using asymmetric sample vessels, using the function **Adjust sample changer** on the balance terminal.



Navigation: ▼ **Methods** >  **Manual operations** >  **Adjust sample changer**

- Open the wizard  **Adjust sample changer**.
  - ➔ The sample changer rotates until **Position 1** is under the tunnel door.
- Open the tunnel door and place the adapter and sample vessel at **Position 1**.
- Close the tunnel door.
- Tap → **Next**.
- Move the dosing head to the desired **Dosing position** using the up and down arrows.
- Tap ✕ **Close**.
- To adjust the height of the dosing head again, tap  **Dosing head position**.
- Adjust the position of the sample vessel using the left and right arrows. Repeat until the tip of the dosing head is aligned with the opening of the sample vessel.
- Tap ✓ **Finish**.
  - ➔ The sample changer adjustment is saved.

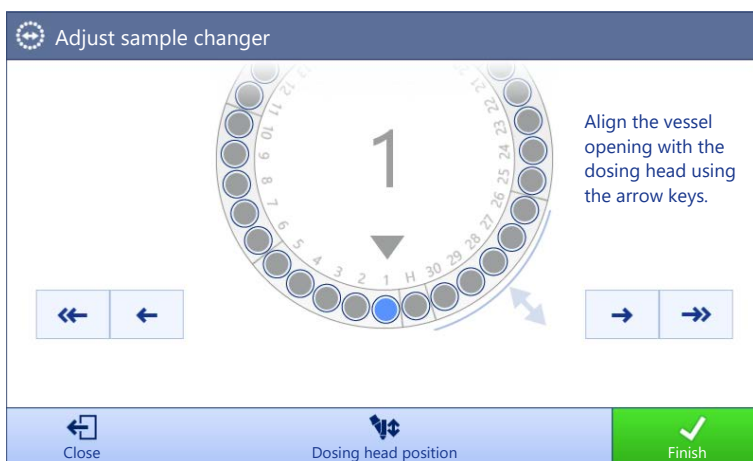

Button	Name	Description
	–	Use these buttons to align the opening of the vessel with the dosing head in large steps.
	–	Use these buttons to align the opening of the vessel with the dosing head in small steps.

## 5.13 Pipette calibration

This section refers to operations related to the **MCP-R pipette calibration module**.

### 5.13.1 Using multiple tolerance profiles

According to ISO 8655-6:2022, the suitable readability of the balance depends on the nominal volume of the pipette to be tested. The readability can be set in the tolerance profile of the method.

This example shows how to set multiple tolerance profiles and how to conveniently switch from one tolerance profile to another. It also provides a list of recommended settings depending on the pipette volume and the balance model.

#### Defining tolerance profiles

≡ Navigation: ► Balance menu > ⚙ Settings > ⚖ Balance > Q<sub>z</sub> Weighing / Quality > Tolerance profiles

- 1 Navigate to the section **Tolerance profiles**.
- 2 Add two new tolerance profiles using the recommended settings below.

#### Recommended settings, XPR105DUHR

Pipette volume, V	0.5 µL ≤ V < 200 µL	200 µL ≤ V ≤ 1000 µL
Readability <sup>1</sup>	0.01 mg	0.1 mg
<b>Tolerance profile, settings:</b>		
<b>Name</b> (example)	5-Place MCP-R	4-Place MCP-R
<b>Environment</b>	<b>Standard</b>	<b>Standard</b>
<b>Weighing mode</b>	<b>Universal</b>	<b>Universal</b>
<b>Value release</b>	<b>Fast</b>	<b>Fast</b>
<b>Display readability</b>	<b>1d</b>	<b>10d</b>

1) recommended by ISO 8655-6:2022, Piston-operated volumetric apparatus, Part 6: Gravimetric reference measurement procedure for the determination of volume

#### Recommended settings, XPR106DUHR

Pipette volume, V	0.5 µL ≤ V < 20 µL	20 µL ≤ V < 200 µL	200 µL ≤ V ≤ 1000 µL	Manual mode	Service mode
Readability	0.002 mg	0.01 mg	0.1 mg	0.002 mg	0.002 mg
<b>Tolerance profile, settings:</b>					
<b>Name</b>	6-Place MCP-R	5-Place MCP-R	4-Place MCP-R	6-Place Manual	6-Place Service
<b>Environment</b>	<b>Standard</b>	<b>Standard</b>	<b>Standard</b>	<b>Standard</b>	<b>Standard</b>
<b>Weighing mode</b>	<b>Universal</b>	<b>Universal</b>	<b>Universal</b>	<b>Universal</b>	<b>Universal</b>
<b>Value release</b>	<b>Fast and reliable</b>	<b>Fast</b>	<b>Very fast</b>	<b>Reliable</b>	<b>Very reliable</b>
<b>Display readability</b>	<b>1d</b>	<b>5d</b>	<b>50d</b>	<b>1d</b>	<b>1d</b>

### Switching between tolerance profiles







- A method **General weighing** is running on the terminal.
  - A computer is connected to the balance.
  - The appropriate tolerance profiles are implemented.
- 1 Tap on the primary weighing result on the balance terminal.
    - ➔ A dialog appears, showing a list of all available tolerance profiles.
  - 2 Select the appropriate **Tolerance profile**.
  - 3 Tap **✓ OK**.

## 6 Software Description

### 6.1 Balance menu settings

The **Balance menu** contains general settings and information. To open the section **Balance menu** tap the tab with the symbol  on the left side of the screen.

The section **Balance menu** is divided into the following subsections.

-  **Leveling aid**
-  **History**
-  **Balance info**
-  **Users** (only appears when user management is activated)
-  **Settings**
-  **Maintenance**

#### 6.1.1 Leveling aid

Exact horizontal positioning and stable installation is essential for repeatable and accurate weighing results. With the **Leveling aid** the balance can be leveled.

≡ **Navigation:** ▶ **Balance menu** >  **Leveling aid**

##### **Note**

After leveling the balance an internal adjustment must be performed.

##### **See also**





 [Leveling the balance](#) ▶ Page 33

#### 6.1.2 History

The balance permanently records the tests and adjustments that are performed in the section **History**

≡ **Navigation:** ▶ **Balance menu** >  **History**



The section **History** is divided into the following subsections.

-  **Adjustments**
-  **Tests**
-  **Alibi memory** (only available for specific balance models)
-  **Service**
-  **Changes** (only appears when change history is activated)

##### 6.1.2.1 Adjustments

≡ **Navigation:** ▶ **Balance menu** >  **History** >  **Adjustments**



A maximum of 500 entries can be stored in the adjustments history.

Button	Name	Description
	Filter	Tap to filter the list: <ul style="list-style-type: none"><li>• <b>By date range</b></li><li>• <b>By user name</b></li></ul>
	Print	Tap to print the displayed entries.
	Close	Tap to return to the section <b>History</b> .

### 6.1.2.2 Tests

☰ **Navigation:** ▶ **Balance menu** > 📄 **History** > 📄 **Tests**

A maximum of 500 entries can be stored in the test history.

Button	Name	Description
	Filter	Tap to filter the list: <ul style="list-style-type: none"><li>• <b>By date range</b></li><li>• <b>By user name</b></li></ul>
	Print	Tap to print the displayed entries.
	Close	Tap to return to the section <b>History</b> .

### 6.1.2.3 Alibi memory

The alibi memory is a tamper-proof data storage device on which weighing data subject to legal control is automatically stored and accessible for a period of time. An alibi memory device operates according to the principle of a "ring" memory: when the capacity limit of the data records and the retention period are reached, the oldest data record in the memory is automatically overwritten by the new data record.

As soon as a result is generated by the balance, it will be stored in the alibi memory of the balance, if the feature is activated. Access to the alibi memory on the balance is provided in stand-alone mode only.

The combination of **Alibi record ID** and **Bridge serial number** ensures the uniqueness of an alibi memory entry. The balance also defines a retention period describing the minimum amount of time during which the results must be stored in the alibi memory. As soon as the retention period for specific alibi entries is exceeded, the balance can reuse these memory slots for new entries.

The alibi memory is only available for specific balance models and needs to be activated by a service technician. Contact your METTLER TOLEDO representative for more details.

When the alibi memory is activated, an alibi record is generated for each result added to the **Results list**. Each alibi record contains the following information:

- **Bridge serial number**
- **Alibi record ID**
- **Date/time**
- **Net weight**
- **Tare weight**
- **Tare weight status**
- **Verification**





#### **Note**

When the **Weight capture mode** is set to **Immediate**, alibi records are only created for stable results.

☰ **Navigation:** ▶ **Balance menu** > 📄 **History** > 📄 **Alibi memory**

A maximum of 500'000 entries can be stored in the alibi memory. When the maximum number of entries is reached and no entries are older than the retention period, no new result can be added to the **Results list**. This can be fixed in service mode, where alibi records can be deleted or the retention period can be shortened.



Button	Name	Description
	Filter	Tap to filter the list: <ul style="list-style-type: none"><li>• <b>By date range</b></li><li>• <b>By record ID range</b></li></ul>

Button	Name	Description
	Print	Tap to print the displayed entries.
	Export	Tap to export the displayed entries.
	Show alibi memory status	Tap to show information about the alibi memory status: <ul style="list-style-type: none"> <li>• <b>Used memory</b></li> <li>• <b>Number of remaining records</b></li> <li>• <b>Retention period</b></li> <li>• <b>Oldest records</b></li> <li>• <b>Newest records</b></li> </ul>
	Alibi memory retention period	The retention period is the minimum period during which the alibi records are stored in the alibi memory. The retention period can range from 1 to 365 days, with a default value of 100 days. It can be edited in service mode.
	Close	Tap to return to the section <b>History</b> .

#### 6.1.2.4 Service

≡ Navigation: ► Balance menu >  History >  Service

A maximum of 500 entries can be stored in the service history.

Button	Name	Description
	Filter	Tap to filter the list: <ul style="list-style-type: none"> <li>• <b>By date range</b></li> <li>• <b>By technician</b></li> </ul>
	Print	Tap to print the displayed entries.
	Close	Tap to return to the section <b>History</b> .

#### 6.1.2.5 Changes



The function **Change history** is an administration tool to improve the traceability of the weighing process. Information such as added methods or settings changes are being listed. Tap into the list to display detailed information about the data.

≡ Navigation: ► Balance menu >  History >  Changes

**Change history** is deactivated in the factory settings. To activate **Change history**, see [Weighing / Quality ► Page 112].

A maximum of 5000 entries can be stored in the change history.

Button	Name	Description
	Filter	Tap to filter the list: <ul style="list-style-type: none"> <li>• <b>By date range</b></li> <li>• <b>By user name</b></li> </ul>



Button	Name	Description
	Print	Tap to print the displayed entries.
	Close	Tap to return to the section <b>History</b> .

### 6.1.3 Balance info

≡ **Navigation:** ▶ **Balance menu** >  **Balance info**

The section **Balance info** shows information about the specific balance about:

- **Identification**
- **Hardware**
- **Modules**
- **Software**
- **Maintenance**

Button	Name	Description
	License agreement	Tap to open the licence agreement.
	Close	Tap to return to the <b>Balance menu</b> .



### 6.1.4 Users

In the section **Users**, rights for users and user groups can be defined. Users can be assigned to user groups. When the user management is active, the login dialog opens at every system start.

The **Users** settings are only visible when the **User management** is set to **Active**.

≡ **Navigation:** ▶ **Balance menu** >  **Users**

The section **User management** is divided into the following subsections:

-  **General**: settings for all users
-  **Users**: settings for individual users
-  **Groups**: settings for user groups

An unlimited number of users can be created. A user is always a part of a user group and has the permissions of the group in which he is. Which user has which permissions can be defined or changed by users with the appropriate permission rights.

#### See also

 [Activating the user management](#) ▶ Page 93

#### 6.1.4.1 General

≡ **Navigation:** ▶ **Balance menu** >  **Users** >  **General**

Parameter	Description	Values
Automatic logout	Defines if the user is automatically logged out after a predefined <b>Wait time</b> .	Active*   Inactive
Wait time	Defines after how long the user automatically gets logged out when no activity is recorded on the balance. This setting is only available if <b>Automatic logout</b> is set to <b>Active</b> .	Numeric (10 minutes*   1...60 minutes)

User proposals	Defines if a list of users appears on the login screen. <b>Active:</b> A list of all users appears, from which a <b>User name</b> can be selected. <b>Inactive:</b> The user needs to type in his <b>User name</b> by hand at login.	Active*   Inactive
Password reset	Defines if the password can be reset from the login screen. If set to <b>Not allowed</b> and the password is lost, a new password cannot be requested. The balance needs to be reset and all data and settings will be lost.	Allowed*   Not allowed

\* Factory setting

### 6.1.4.2 Users

Navigation: ► Balance menu > 👤 Users > 👤 Users

Parameter	Description	Values
User name	Defines a unique identifier for the user. When the user profile has been defined, the value for <b>User name</b> will be fixed and cannot be changed afterwards.	Text (1...22 characters)
Last name	Defines the last name of the user.	Text (0...22 characters)
First name	Defines the first name of the user.	Text (0...22 characters)
Active	Activates or deactivates the current user.	Active*   Inactive
Assigned groups	Assigns user to user groups.	List of defined groups
User language	Defines the language of the user profile.	Available languages

\* Factory setting

An unlimited number of users can be created. A user is always a part of a user group and has the permissions of the group in which he is. Which user has which permissions can be defined or changed by users with the appropriate permission rights.

### 6.1.4.3 Groups

Navigation: ► Balance menu > 👤 Users > 👤 Groups

#### Note

This area is only accessible for users with the appropriate rights.

Parameter	Description	Values
Group name	Defines the name of the group.	Text (1...22 characters)

#### General permissions

Parameter	Description	Values
Block / unblock balance	Defines if the group is allowed to block or unblock the balance.	Active   Inactive
Configure methods	Defines if the group is allowed to: <ul style="list-style-type: none"> <li>• create new methods</li> <li>• edit methods</li> <li>• delete methods</li> <li>• lock or unlock methods</li> <li>• import or export methods</li> </ul>	Active   Inactive



Execute service commands	Defines if the group is allowed to: <ul style="list-style-type: none"> <li>• access service function</li> <li>• block/unblock the balance</li> <li>• view adjustment state</li> <li>• generate support files</li> </ul>	Active   Inactive
Configure system	Defines if the group is allowed to: <ul style="list-style-type: none"> <li>• modify system settings</li> <li>• import system settings</li> <li>• configure peripherals</li> <li>• perform software updates</li> <li>• perform application or factory settings</li> </ul>	Active   Inactive
Configure user management	Defines if the group is allowed to: <ul style="list-style-type: none"> <li>• print or export/import user management settings</li> <li>• modify user management settings</li> <li>• enable or disable user management</li> </ul>	Active   Inactive
Cancel task	Defines if the group is allowed to cancel a task during the execution of a method.	Active   Inactive
Exclude / Overwrite result	Defines if the group is allowed to exclude or overwrite results in the <b>Results list</b> .	Active   Inactive
Reset the time span statistics	Defines if the group is allowed to: <ul style="list-style-type: none"> <li>• reset the time span statistics when using the method <b>SQC</b></li> </ul>	Active   Inactive

### Quality management permissions

Parameter	Description	Values
Start external adjustment	Defines if the group is allowed to perform external adjustments.	Active   Inactive
Show change history	Defines if the group is allowed to see the <b>Change history</b> .	Active   Inactive
Configure routine tests / GWP	Defines if the group is allowed to: <ul style="list-style-type: none"> <li>• configure routine tests</li> <li>• import or export routine tests</li> <li>• configure and import test weights</li> <li>• configure tolerance profiles</li> <li>• activate/deactivate the GWP approval mode</li> </ul>	Active   Inactive
Start routine tests	Defines if the group is allowed to perform routine tests.	Active   Inactive

The settings related to the screen brightness and the sound can be edited by all users and changes are applied to all users. Any user can set a user-specific language for the balance interface without influencing the settings of other users.

## 6.1.5 Settings

This section describes the settings of the balance that can be changed to suit specific requirements. The balance settings apply to the entire weighing system and to all users.

☰ **Navigation:** ► **Balance menu** > ⚙️ **Settings**

The section **Settings** is divided into the following subsections:





- 🏠 **Balance**
- 🧪 **Modules / Dosing**
- 🖨️ **Interfaces**
- 🖨️ **Devices / Printers**

-  LabX / Services

### 6.1.5.1 Balance

≡ Navigation: ► Balance menu > ⚙ Settings > ⚖ Balance

The section **Balance** is divided into the following subsections:

-  Weighing / Quality
-  Doors
-  Date / Time / Language / Format
-  Screen / StatusLight / Sound
-  General

#### Weighing / Quality

≡ Navigation: ► Balance menu > ⚙ Settings > ⚖ Balance >  Weighing / Quality

Parameter	Description	Values
Leveling warning	<p>Defines the action when the balance is out of level</p> <p>When <b>Forced leveling</b> is selected and the balance is out of level, no weighing value can be added to the <b>Results list</b> (green button disabled).</p> <p>For approved balances, this setting is set to <b>Forced leveling</b> and cannot be edited.</p>	Inactive   Optional leveling*   Forced leveling
Electrostatic detection	<p>Defines the condition of the environment for the electrostatic detection.</p> <p><b>Standard environment:</b> Choose this option if operating in a stable environment.</p> <p><b>Unstable environment:</b> Choose this option if operating in an unstable environment, i.e. where <b>Standard environment</b> setting is not enough for the balance to determine the electrostatic weighing error.</p>	Standard environment*   Unstable environment
Tolerance profiles	<p>A tolerance profile stores all the necessary balance settings needed for a certain weighing method. It is possible to create different tolerance profiles for different weighing methods.</p> <p>This section contains several settings that are described in the table <b>Tolerance profiles</b> below.</p>	
Automatic weight value output	<p>Defines if and in which manner (<b>MT-SICS</b> and/or <b>HID</b>) the weighing values should be exported.</p> <p>This section contains several settings that are described in the table <b>Automatic weight value output</b> below.</p>	

GWP Approved mode	<p>Good Weighing Practice (GWP®) is a program started by METTLER TOLEDO to help customers operate their weighing equipment in a safe and efficient way. It covers every relevant step in the life cycle of the instrument and provides clear guidance on how to specify, calibrate and operate weighing instruments.</p> <p>The GWP Approved mode observes if the following conditions are given:</p> <ul style="list-style-type: none"> <li>• Use of an appropriate tolerance profile.</li> <li>• The internal adjustment was successful.</li> <li>• Required tests were successful.</li> <li>• Setting up of enforced leveling.</li> <li>• No MinWeigh violation.</li> </ul> <p>If all conditions are given, the balance adds the GWP Approved sign behind every weighing result.</p> <p>The <b>GWP Approved mode</b> can only be enabled by a METTLER TOLEDO service technician.</p>	Active   Inactive*
Change history	<p>The change history is used to log changes to system settings, user management and methods as well as other settings and configurations. The following information is stored:</p> <ul style="list-style-type: none"> <li>• User ID and timestamp</li> <li>• Object identifier</li> <li>• Old values and new values of attributes</li> </ul> <p>A maximum of 5000 entries can be stored in the change history. For more information see [Changes ► Page 108].</p>	Active   Inactive*
Balance recalib. reminder	Defines whether the user is reminded about the upcoming expiry date of the calibration.	Active*   Inactive
Days in advance	<p>Defines the number of days before the due date the recalibration reminder is shown.</p> <p>This setting is only available if <b>Balance recalib. reminder</b> is set to <b>Active</b>.</p>	Numeric (30 days*   0...400 days)
Action when calib. expired	<p>Defines the action when the calibration has expired.</p> <p><b>Block:</b> The balance will be blocked. In this case, the balance cannot be used anymore until a user unblocks the balance. If <b>User management</b> is <b>Active</b>, only users with the appropriate rights can unblock the balance.</p>	None*   Block
Days before blocking	Defines the number of days before the reminder informs about the upcoming expiry date.	Numeric (30 days*   0...400 days)
Weight recalib. reminder	Defines whether the user is reminded about the upcoming expiry date of the test weight calibration.	Active   Inactive*
Days in advance	<p>Defines the number of days before the due date the recalibration reminder is shown.</p> <p>This setting is only available if <b>Weight recalib. reminder</b> is set to <b>Active</b>.</p>	Numeric (30 days*   0...400 days)
Service reminder	Defines whether the user is reminded about the upcoming due date of the service.	Active   Inactive*
Days in advance	<p>Defines the number of days before the due date the service reminder is shown.</p> <p>This setting is only available if <b>Service reminder</b> is set to <b>Active</b>.</p>	Numeric (30 days*   0...400 days)

\* Factory setting

## Tolerance profiles

Settings relating to weighing performance and data from balance calibration can be stored in a tolerance profile.

For more information about creating tolerance profiles, see [Tolerance profiles ▶ Page 94]

Parameter	Description	Values
Name	Defines the name of the profile.	Text (0...22 characters)
Indicator	Defines the color of the indicator icon for the tolerance profile. The icon will appear above the weighing value unit. When a color is selected, a description of maximum 3 characters can be added.	None*   Neutral   White   Yellow   Red   Blue   Green   Black
Indicator text	Defines the text of the indicator icon.	Text (0...3 characters)
Calibration certificate	Selects a calibration certificate from a drop-down list of certificates available on the balance. New certificates can only be created by a service technician based on a performed balance calibration.	Calibration certificate   None*
Environment	Defines the environmental conditions of the balance. <b>Very stable:</b> For an environment that is free from any drafts and vibrations. <b>Stable:</b> For an environment that is practically free from drafts and vibrations. <b>Standard:</b> For an average working environment subject to moderate variations in the ambient conditions. <b>Unstable:</b> For an environment where the conditions are from time to time changing. <b>Very unstable:</b> For an environment where the conditions are continuously changing.	Very stable   Stable   Standard*   Unstable   Very unstable
Weighing mode	Defines the filter settings of the balance. <b>Universal:</b> For all standard weighing applications. <b>Sensor mode:</b> Depending on the setting of the ambient conditions, this setting delivers a filtered weighing signal of varying strength. The filter has a linear characteristic in relation to time (not adaptive) and is suitable for continuous measured value processing.	Universal*   Sensor mode
Value release	Defines the speed at which the balance regards the measured value as stable and available for capture. <b>Very fast:</b> recommended if you require fast results and repeatability is not very important. <b>Very reliable:</b> provides very good repeatability of the measured results but prolongs the stabilization time. Some intermediate settings can also be chosen from.	Very fast   Fast   Fast and reliable*   Reliable   Very reliable
Display readability	Determines the readability <b>d</b> of the balance display. <b>1d:</b> Shows the maximum resolution <b>2d:</b> 2 times smaller resolution <b>5d:</b> 5 times smaller resolution <b>10d:</b> 10 times smaller resolution <b>100d:</b> 100 times smaller resolution <b>1000d:</b> 1000 times smaller resolution For approved balances, the values available for this setting depend on the balance model.	1d*   2d   5d   10d   100d   1000d

Zero drift compensation	The function <b>Zero drift compensation</b> performs ongoing corrections of deviations from zero which may occur, for example, as a result of small amounts of dirt on the weighing pan.  For approved balances, the values available for this setting depend on the balance model.	Active*   Inactive
Allowed units	Defines the units that are allowed in this tolerance profile.	The available values are model-specific.

\* Factory setting

### Automatic weight value output

The balance can be connected to a computer with a USB cable. Weighing results can then be directly transferred to a target application, e.g., Microsoft Excel.

Parameter	Description	Values
Output mode	Defines which weighing values are transferred via the communication interface, e.g., USB, Ethernet.  <b>Results:</b> The weighing values are transferred only when they are added to the <b>Results list</b> .  <b>Continuous:</b> The weighing values are transferred continuously via the interface defined under <b>LabX / Services &gt; MT-SICS</b> . Additional fields are available, depending on the chosen option.	Results*   Continuous
Target	Defines the way the weighing values are transferred.  <b>HID</b> (Human Interaction Device): Transfers simple character streams (e.g. weight values) to a desktop computer without installing additional drivers (comparable to a keyboard). The format of a transferred weighing value can be configured.  <b>MT-SICS:</b> The data is transferred in MT-SICS format (METTLER TOLEDO Standard Interface Command Set). MT-SICS operates bidirectional, i.e. usually balance sends the confirmations to the host and receives commands. A separate reference manual is available for MT-SICS.  <b>HID / MT-SICS:</b> The data is transferred in HID and MT-SICS format in parallel.  <b>MT-SICS configurable:</b> The data is transferred in a user-defined MT-SICS format.  This setting is only available if <b>Output mode</b> is set to <b>Results</b> .	HID*   HID / MT-SICS   MT-SICS   MT-SICS configurable
Result ID 1 Result ID 2	Defines if the fields <b>Result ID 1</b> and <b>Result ID 2</b> are included in the output, respectively. Supported characters are: <ul style="list-style-type: none"> <li>• numbers: 0 – 9</li> <li>• letters: a – z and A – Z</li> <li>• special characters: space, dot, comma, semicolon, plus, minus</li> </ul> Non-supported characters will be replaced by a space. This setting is only available if <b>Output mode</b> is set to <b>Results</b> .	Active   Inactive*
Date	Defines if the field <b>Date</b> is included in the output. The format of the date is <b>YYYY-MM-DD</b> .  This setting is only available if <b>Output mode</b> is set to <b>Results</b> .	Active   Inactive*

Time	Defines if the field <b>Time</b> is included in the output. The format of the time is <b>hh-mm-ss</b> . This setting is only available if <b>Output mode</b> is set to <b>Results</b> .	Active   Inactive*
Net indicator	In the standard output format, net weights are not specially marked. To place an N in front of net weights, this function can be activated. The net symbol is left-justified in the field. This setting is only available if <b>Output mode</b> is set to <b>Results</b> .	Active   Inactive*
Net indicator field length	Defines the field length of the Net indicator. This setting is only available if <b>Output mode</b> is set to <b>Results</b> and <b>Net indicator</b> is set to <b>Active</b> .	Numeric (2*   1...2)
Weight field length	Defines the number of digits that will be transferred into the application on the computer, e.g., into an Excel field. This setting is only available if <b>Output mode</b> is set to <b>Results</b> .	Numeric (1*   0...20)
Sign	Defines if the weighing result is displayed with an algebraic sign. <b>For all values:</b> Each weighing result is preceded by a plus or minus sign. <b>For negative values:</b> Only negative values are preceded by a minus sign. Positive values are transferred without algebraic sign. This setting is only available if <b>Output mode</b> is set to <b>Results</b> .	For all values   For negative values*
Sign position	Defines if the algebraic sign is positioned at the first place of the weight field or directly in front of the weight digits. This setting is only available if <b>Output mode</b> is set to <b>Results</b> .	Left of weight field   Left of weight digits*
Decimal delimiter	Defines the character used to separate the whole and fractional part of a numeric value. This setting is only available if <b>Output mode</b> is set to <b>Results</b> .	,   .*
Unit	Defines if a weight unit is being shown in the weighing field. This setting is only available if <b>Output mode</b> is set to <b>Results</b> .	Active*   Inactive
Unit field length	Defines the field length of the weight unit. This setting is only available if <b>Output mode</b> is set to <b>Results</b> and <b>Unit</b> is set to <b>Active</b> .	Numeric (1*   1...6)
Field delimiter	Defines a character or sequence of characters to separate data fields. This setting is only available if <b>Output mode</b> is set to <b>Results</b> .	None   Space*   TAB   ,   ;
End of line character	Defines a character or sequence of characters signifying the end of a line. This setting is only available if <b>Output mode</b> is set to <b>Results</b> .	CRLF   CR   LF   TAB   None   Enter*
Updates/sec.	Defines the rate at which data is transferred. This setting is only available if <b>Output mode</b> is set to <b>Continuous</b> .	2   5   6*   10
Format	Defines the format of the transferred data. This setting is only available if <b>Output mode</b> is set to <b>Continuous</b> .	MT-SICS*   PM   AT/MT

\* Factory setting

## Doors

☰ **Navigation:** ► **Balance menu** > ⚙️ **Settings** > ⚖️ **Balance** > 🚪 **Doors**



Each of the following doors can be managed separately:

- **Door left**
- **Door right**

- **Door top**

**Note**

If user management is active, individual door settings can be configured for each user.

Parameter	Description	Values
Drive mode	Defines the mode to open/close the door.	Motorized*   Manual
Door opening	Defines how far the door opens. This setting is only available if <b>Drive mode</b> is set to <b>Motorized</b> . Enter the value manually or capture it by tapping on  . The door will be open with the configured value.	Numeric (1 ... 100%)
Door key left	Defines the automation of the left door key  on the terminal.	Active   Inactive*
Door key right	Defines the automation of the right door key  on the terminal.	Active   Inactive*
SmartSens left	Defines the touchless door function of the left optical sensor.	Active   Inactive*
SmartSens right	Defines the touchless door function of the right optical sensor.	Active   Inactive*
Devices	Defines the door opening or closing via an external device, such as an ErgoSens or a foot switch. If set to <b>Active</b> , the <b>Function</b> of the corresponding device also needs to be set to <b>Door</b> . See <b>Devices / Printers</b> .	Active   Inactive*
Automatic (Tare / Zero / Result)	Closes the door automatically when taring the balance, zeroing the balance, or adding a result to the <b>Results list</b> .	Active   Inactive*
System defaults	Defines the default settings that are applied for newly created users. This setting is only available if <b>User management</b> is set to <b>Active</b> .	

\* Factory setting for the right door / for the left door reverse

**See also**

 [Devices / Printers](#) ▶ Page 121

**Date / Time / Language / Format**

☰ **Navigation:** ▶ **Balance menu** >  **Settings** >  **Balance** >  **Date / Time / Language / Format**

Parameter	Description	Values
Date	Defines the current date.	Date
Time	Defines the current time. Use the plus/minus buttons to define the time.	Time
Language	Defines the language of the interface navigation.	English   Deutsch   Français   日本語   中文   Español   Italiano   Русский   Português   Polski   Magyar   Čeština
Time zone	Selects a time zone. When the time zone is set, the balance changes automatically between summer and winter time.	see list on the screen
Date format	Selects the date format.	D.MMM.YYYY*   MMM D YYYY   DD.MM.YYYY   MM/DD/YYYY   YYYY-MM-DD   YYYY/MM/DD   YYYY年M月D日
Time format	Selects the time format.	24:MM*   12:MM   24.MM   12.MM

Keyboard layout	Defines the language of the keyboard layout.	English   German   French   Spanish   Japanese   Simplified Chinese   Russian   Czech   Polish   Hungarian
System defaults	Defines the default settings that are applied for newly created users. This setting is only available if <b>User management</b> is set to <b>Active</b> .	

\* Factory setting

## Screen / StatusLight / Sound

Navigation: ► Balance menu > ⚙ Settings > ⚖ Balance > \*📺 Screen / StatusLight / Sound

Parameter	Description	Values
Screen brightness	Defines the brightness of the display.	20 %   40 %   60 %   80 %*   100 %
Sound volume	Defines the volume of the terminal sound.	Inactive   20 %   40 %   60 %*   80 %   100 %
Sound on key press	Defines if there is a sound when a key is pressed.	Active*   Inactive
Sound on info	Defines if there is a sound when an information appears on the screen.	Active*   Inactive
Sound on warning	Defines is there is a sound when a warning appears on the screen.	Active*   Inactive
Sound on error	Defines is there is a sound in case of an error.	Active*   Inactive
StatusLight	Activates/deactivates the <b>StatusLight</b> . <b>Active (without green light)</b> : All current status of the balance are monitored, the red/yellow lights will turn on if needed, but the green light will stay turned off. <ul style="list-style-type: none"> <li>• <b>StatusLight</b> is red: Error. The balance must not be used until the error is corrected.</li> <li>• <b>StatusLight</b> is yellow: Warning. For example, the test manager has pushed a test to the balance or you are operating the balance between the date of the calibration reminder and the scheduled date of the next calibration. The balance can still be used.</li> <li>• <b>StatusLight</b> is green or off: Ok. No problems detected and the balance is ready to weigh.</li> </ul>	Active*   Active (without green light)   Inactive
StatusLight brightness	Defines the brightness of the activated <b>StatusLight</b> . This setting is only available if <b>StatusLight</b> is set to <b>Active</b> or <b>Active (without green light)</b> .	20 %   40 %   60 %*   80 %   100 %

\* Factory setting



## General

Navigation: ► Balance menu > ⚙ Settings > ⚖ Balance > ⚙ General

Parameter	Description	Values
Balance ID	Defines the ID of the balance. This name could be used to communicate with the balance over a network. No space or special characters are allowed.	Text (0...22 characters)
Standby	Defines if the balance automatically enters standby mode after not being used for a predefined <b>Wait time</b> . <b>If User management</b> is active, the user will be automatically logged out when the balance switches to standby mode. The standby mode can always be started manually by pressing  .	Active*   Inactive
Wait time	Defines after how long the balance automatically switches to standby mode when not used. This setting is only available if <b>Standby</b> is set to <b>Active</b> .	Numeric (10 minutes*   0...60 minutes)
Software update on system start-up	With this option activated, software update can be performed from a USB storage device on startup.	Active*   Inactive
Automatic export directory	Defines the target directory for the automatic export. The possibility to export to <b>File server</b> is only available if a <b>File server</b> is configured (see [LabX / Services ► Page 123]).	USB storage device*   File server
User management	Activates/Deactivates the <b>User management</b> .	Active   Inactive*

\* Factory setting

### 6.1.5.2 Modules / Dosing

Navigation: ► Balance menu > ⚙ Settings > ⚖ Modules / Dosing

#### Dosing module / Dosing head

Parameter	Description	Values
Dosing head label	Defines the template of the dosing head label to be printed, i.e., which data is included on the label and in which format. This section contains several settings that are described in the table <b>Dosing head label</b> below.	

#### Pump devices

Parameter	Description	Values
Pressure hold duration	Defines the duration for the pump to hold the pressure when the liquid dosing head is not in use.	Numeric (10 minutes*   1...180 minutes)

\* Factory setting

#### Dosing head label

Parameter	Description	Values
Copies	Defines how many copies of the label are printed.	Numeric
Used template	Chooses the label template.	Available labels are shown below.





## Field settings

The content of each label field can be defined individually.

Parameter	Description	Values
Label field 1	Defines which information appears in each label field. The number of label fields depends on the selected template.	Available entries depend on the method settings.

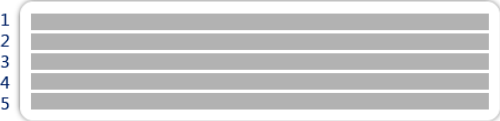
## Available labels

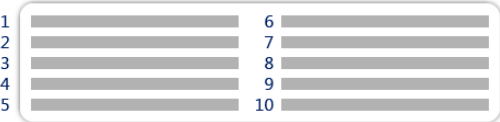
The following label layouts can be selected:

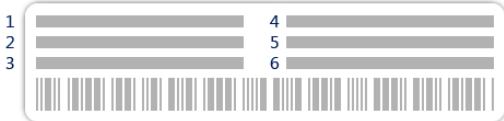
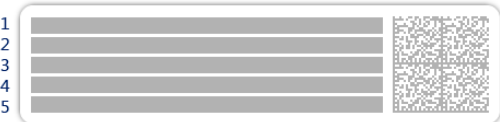
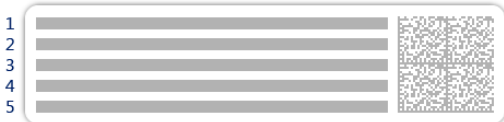
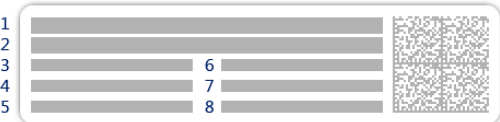
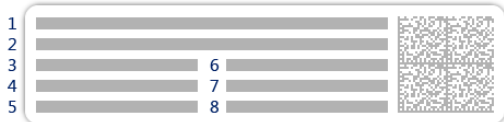
 <p>1 2 3 4 5</p>	 <p>1 2 3 4 5</p>
5 large fields	5 small fields
 <p>1 2 3 4 5</p> <p>6 7 8 9 10</p>	 <p>1 2 3</p>
10 small fields	1D barcode with 3 large fields
 <p>1 2 3</p>	 <p>1 2 3</p> <p>4 5 6</p>
1D barcode with 3 small fields	1D barcode with 6 small fields
 <p>1 2 3 4 5</p>	 <p>1 2 3 4 5</p>
2D barcode with 5 large fields	2D barcode with 5 small fields
 <p>1 2 3 4 5</p> <p>6 7 8</p>	 <p>1 2 3 4 5</p> <p>6 7 8</p>
2D barcode with 2 large fields and 6 small fields	2D barcode with 8 small fields

### 6.1.5.3 Interfaces

☰ **Navigation:** ► **Balance menu** > ⚙️ **Settings** > 📶 **Interfaces**

The section **Interfaces** has the following subsection:

- 🌐 **Ethernet**
- 📶 **Bluetooth**

## Ethernet

The **Ethernet** interface allows to connect the balance to a network in order to:

- store weighing results as XML files on a share folder
- communicate remotely with the balance using the MT-SICS communication protocol or LabX

☰ **Navigation:** ▶ **Balance menu** > ⚙️ **Settings** > 🖨️ **Interfaces** > 🌐 **Ethernet**

Parameter	Description	Values
Host name	Defines the balance host name.	Text (1...22 characters)
MAC address	Information on the MAC address (Media Access Control) that is used to uniquely identify the balance in the network.	
Network configuration	<b>DHCP:</b> The settings of the Ethernet connection will be automatically set. <b>Manual:</b> The settings of the Ethernet connection must be set manually by the user.	DHCP*   Manual
IP address	If the IP is not to be automatically obtained, you can enter it here.	000.000.000.000... 255.255.255.255
Subnet mask	Defines the subnet mask that is used by the TCP/IP protocol to determine whether a host is on the local subnet or on a remote network.	000.000.000.000... 255.255.255.255
DNS server (primary)	Defines the address of the primary DNS (domain name system) server.	000.000.000.000... 255.255.255.255
DNS server (secondary)	Defines the address of the secondary DNS server.	000.000.000.000... 255.255.255.255
Default gateway	Defines the address of the default gateway that links the host's subnet to other networks.	000.000.000.000... 255.255.255.255

\* Factory setting

## Bluetooth

☰ **Navigation:** ▶ **Balance menu** > ⚙️ **Settings** > 🖨️ **Interfaces** > 📶 **Bluetooth**

### Bluetooth identification

Parameter	Description	Values
Activation	With the option <b>Bluetooth</b> you have the possibility to communicate with a printer via Bluetooth.	Inactive*   Active

\* Factory setting

### 6.1.5.4 Devices / Printers

☰ **Navigation:** ▶ **Balance menu** > ⚙️ **Settings** > 🖨️ **Devices / Printers**

This section is divided into the following subsections:

- 🖨️ **Printer**
- 📷 **Barcode reader**
- 📶 **RFID reader**
- 🌀 **ErgoSens**
- 🦶 **Foot switch**
- 🚰 **Pump**

## Printer

Navigation: ► Balance menu > Settings > Devices / Printers > Printer

### Printer settings

Parameter	Description	Values
Printer category	Defines the type of the printer. <b>Strip printer:</b> to print weighing results on strip paper <b>Label printer:</b> to print weighing results on labels	Strip printer   Label printer*
Device	Allows to activate or deactivate the device.	Activated*   Deactivated
Line end	Defines the line end character for printing. The values set here have to match the printer settings. This setting is only available for strip printers.	<CR> <LF>*   <CR>   <LF>
Character set	Defines the communication specific character code. The values set here have to match the printer settings. This setting is only available for strip printers.	ANSI/WIN   IBM/DOS   UTF8*

\* Factory setting

## Barcode reader

Navigation: ► Balance menu > Settings > Devices / Printers > Barcode reader

Once connected to a USB port of the balance, the device is automatically recognized. The settings can be consulted here.

## RFID reader

Navigation: ► Balance menu > Settings > Devices / Printers > RFID reader

Once connected to a USB port of the balance, the device is automatically recognized. The settings can be consulted here.

## ErgoSens

Navigation: ► Balance menu > Settings > Devices / Printers > ErgoSens

Parameter	Description	Values
Function	Defines which function is to be executed when triggering the device. If set to <b>Door</b> , the setting <b>Balance &gt; Doors &gt; Devices</b> needs to be specified.	None*   Door   Zero   Tare   Add result

\* Factory setting

## Foot switch

Navigation: ► Balance menu > Settings > Devices / Printers > Foot switch

Parameter	Description	Values
Function	Defines which function is to be executed when triggering the device. If set to <b>Door</b> , the setting <b>Balance &gt; Doors &gt; Devices</b> needs to be specified.	None*   Door   Zero   Tare   Add result

\* Factory setting

## Pump

Navigation: ► Balance menu > Settings > Devices / Printers > Pump

Once connected to a USB port of the balance, the device is automatically recognized. The settings can be consulted here.

### See also

- Printer ▶ Page 76
- Barcode reader ▶ Page 80
- RFID reader ▶ Page 81
- Foot switch and ErgoSens ▶ Page 83
- Pump ▶ Page 84
- Doors ▶ Page 116

#### 6.1.5.5 LabX / Services

Several services are available to communicate with the balance: **LabX service**, **MT-SICS service**, or **Web service**. Note that only one service can be enabled at any given time.

To enable communication between LabX and instruments, the appropriate settings on the instruments must correspond with the settings in LabX. LabX synchronizes the date and time on the instruments with the LabX Server each time a connection is made and each time a task is started. When an instrument is connected, the user interface language on the connected instrument is changed to the language currently installed on the LabX installation.

☰ **Navigation:** ▶ **Balance menu** > ⚙️ **Settings** > 🏠 **LabX / Services**

Parameter	Description	Values
LabX service	<b>Inactive:</b> No connection to LabX will be established. <b>Network:</b> A network connection to LabX will be established on startup. The <b>Port</b> must be specified. <b>USB:</b> A USB connection to LabX will be established on startup.	Inactive*   Network   USB
MT-SICS service	<b>Inactive:</b> No MT-SICS port will be opened. <b>Network:</b> An MT-SICS network port will be opened on startup. The <b>Port</b> must be specified. <b>USB:</b> An MT-SICS USB port will be opened on startup.	Inactive*   Network   USB
Web service	If set to <b>Active</b> , a network port will be opened on startup. Use the menu <b>Web service configuration</b> to configure the service. The complete <b>Web service</b> documentation is available online: ▶ <a href="http://www.mt.com/labweighing-software-download">www.mt.com/labweighing-software-download</a> .	Inactive*   Active
File server	Allows to define a file server to import/export data. If set to <b>Active</b> , use the menu <b>File server configuration</b> to configure the server.	Active   Inactive*

\* Factory setting

### See also

- LabX service ▶ Page 85
- MT-SICS service ▶ Page 86
- Web service ▶ Page 88
- Data management ▶ Page 89

#### 6.1.5.6 Printing the settings

☰ **Navigation:** ▶ **Balance menu** > ⚙️ **Settings**

When all the balance settings are configured, you can print the complete list to archive the information.

- To print the balance settings, tap 🖨️ **Print the settings**.
  - ➔ The complete balance settings are printed.

## 6.1.6 Maintenance





≡ Navigation: ▶ Balance menu >  Maintenance

The option **Maintenance** only appears if the user has the appropriate user rights.

The section **Maintenance** is divided into the following subsections:







-  **Import / Export**
-  **Format RFID**
-  **Software update**
-  **Reset**
-  **Service menu**

### See also

-  Data management ▶ Page 89
-  RFID reader ▶ Page 81
-  Software update ▶ Page 220
-  Resetting the balance ▶ Page 97

### 6.1.6.1 Service menu

≡ Navigation: ▶ Balance menu >  Maintenance >  Service menu

Icon	Name	Description
  	<b>Device errors</b>	<p>Tap to display the code of an error. This error code can be useful in your communication with METTLER TOLEDO when troubleshooting your device. The icon depends on the severity of the error: critical error, warning, or information.</p> <p>The icons of device errors only appear when an error with an error code is ongoing on the device.</p>
	<b>Show adjustment state</b>	<p>Tap to open information about:</p> <ul style="list-style-type: none"> <li>• <b>Prescaler</b></li> <li>• <b>Temperature compensation</b></li> <li>• <b>Production linearization</b></li> <li>• <b>Standard calibration</b></li> <li>• <b>Production calibration</b></li> <li>• <b>User linearization</b></li> <li>• <b>User calibration</b></li> </ul>
	<b>Save support file</b>	Tap to save support file (all relevant information to an error) on a USB storage device to send it to a METTLER TOLEDO representative.
	<b>Import log configuration</b>	<p>A log configuration file can be provided by METTLER TOLEDO to allow a more comprehensive collection of balance parameters to be stored in the support file. This is only used for troubleshooting purposes.</p> <p>Tap to import the log configuration from a USB storage device so that the enhanced list of parameters can be exported and sent to a METTLER TOLEDO representative.</p>
	<b>Perform initial zero</b>	<p>Tap to perform an initial zero of the balance. This can be useful when using accessories whose weight exceeds the zeroing range of the balance, for example a density kit.</p> <p>This function is only available for approved balances.</p>

## 6.2 Weighing methods settings

### 6.2.1 Settings: method "General weighing"

In this section, the settings of the methods **General weighing** and **General weighing (itemized)** are described. Settings can be edited for a newly created method or an already existing method.

☰ **Navigation:** ▾ **Methods** > ☰ **Methods list** > ⚙ **my general weighing** > ✎ **Edit**

Category	Parameter	Value
General	Method type	General weighing
ID format	Method name	my general weighing
Weighing	Comment	Enter here
Weighing item	Lock method	<input type="checkbox"/>

The settings of the method **General weighing** are grouped as follows:

- ☰ **General**
- 🆔 **ID format**
- ⚙ **Weighing**
- ⚙ **Weighing item**, only available for the method **General weighing**
- ⚙ **Weighing items**, only available for the method **General weighing (itemized)**
- ⚙ **Automation**
- 🖨 **Print / Export**

#### See also

- 🔗 [Creating a method "General weighing" ▶ Page 40](#)
- 🔗 [Editing a method ▶ Page 63](#)

#### 6.2.1.1 General

The **Method type** is defined in the wizard while creating the method and cannot be changed.

Parameter	Description	Values
Method name	Defines the name of the method.	Text (1...22 characters)
Comment	The method can be described with a comment.	Text (0...128 characters)
Lock method	Locks the method to prevent further editing.	Active   Inactive*

\* Factory setting

## 6.2.1.2 ID format

### Task IDs

Parameter	Description	Values
Number of task IDs	Defines the number of task IDs. If the <b>Number of task IDs</b> is larger than 0, the settings <b>Task ID</b> , <b>Task description</b> and <b>Prefix/Default value</b> are available for every single task ID.	0   1*   2   3
Task ID 1	Defines the naming type of the task ID. <b>Manual with default:</b> The value of the task ID can be entered manually at method execution time. <b>Automatic timestamp:</b> The system provides a value created from a prefix with the current date and time appended.	Manual with default*   Automatic timestamp
Task description	Allows to define a label for each task ID field.	Text (0...32 characters)
Default value	Defines a default value for the task ID. The value of the task ID can be changed manually while executing the method. This setting is only available when the corresponding <b>Task ID</b> is set to <b>Manual with default</b> .	Text (0...32 characters)
Prefix	Defines a prefix for the task ID. This setting is only available is the corresponding <b>Task ID</b> is set to <b>Automatic timestamp</b> .	Text (0...32 characters)

\* Factory setting

### Result IDs

Parameter	Description	Values
Number of result IDs	Defines the number of result IDs. If the <b>Number of result IDs</b> is larger than 0, the settings <b>Result ID</b> , <b>Result description</b> and <b>Prefix/Default value</b> are available for every single result ID.	0   1*   2   3
Result ID 1	Defines the naming type of the result ID. <b>Manual with default:</b> The value of the result ID can be entered manually at method execution time. <b>Automatic counter:</b> The system provides a value created from a <b>Prefix</b> to which is appended a unique number (counter).	Manual with default*   Automatic counter
Result description	Allows to define a label for each result ID.	Text (0...32 characters)
Default value	Defines a default value for the result ID. The value of the result ID can be changed manually while executing the method. This setting is only available when the corresponding <b>Result ID</b> is set to <b>Manual with default</b> .	Text (0...32 characters)
Prefix	Defines a prefix for the result ID. This setting is only available if the corresponding <b>Result ID</b> is set to <b>Automatic counter</b> .	Text (0...32 characters)

\* Factory setting

## 6.2.1.3 Weighing

Parameter	Description	Values
Show info weight	When set to <b>Active</b> , a secondary weight is displayed on the weighing screen.	Active   Inactive*



Info unit	Defines the unit of the <b>Info weight</b> . This setting is only available if <b>Show info weight</b> is set to <b>Active</b> .	The available units depend on the balance model.
-----------	---	--

\* Factory setting

### Custom unit

When the parameter **Define custom unit** is activated, additional parameters can be defined.

Parameter	Description	Values
Define custom unit	With this option activated, a specific weight unit can be defined. This allows calculations, e.g., surfaces or volumes, to be carried out directly during the determination of the weighing result. If a custom unit is defined, this unit is added to the list of available units throughout the method.	Active   Inactive*
Name	Defines the name of the custom unit.	Text (0...6 characters)
Formula	Defines how subsequently defined value for <b>Factor</b> is calculated. There are 2 formulae available: <b>Multiplicative</b> : Multiplies the net weight by the factor. <b>Divisive</b> : The factor is divided by the net weight. The formula can be used, for example, to simultaneously take into account a known error factor while weighing.	Multiplicative*   Divisive
Factor	Defines the factor with which the effective weighing result (net weight) is calculated via the previously selected <b>Formula</b> .	Numeric
Display readability	Defines the formatting for the weighing result. Example: A setting of "0.05" defines two places after the decimal point with rounding to 5. A determined result of 123.4777 is consequently displayed as 123.50. This function can only be used to reduce the resolution of the weighing result. No value must therefore be entered that exceeds the maximum balance resolution. Values that are too small are automatically rounded off.	Numeric

\* Factory setting

### Weighing settings

Parameter	Description	Values
Tolerance profile	A tolerance profile stores all the necessary balance settings needed for a certain weighing method. It is possible to create different tolerance profiles for different weighing methods.	Tolerance profiles are created by the user for specific balances and applications.
Weight capture mode	Defines the behavior when the button to add the result was tapped or the add result was triggered by the automatic weighing result creation. <b>Stable</b> : The system waits for a stable weight. <b>Immediate</b> : The system doesn't wait for a stable weight. The system waits for the defined amount of seconds ( <b>Weight capture delay</b> ). After the weight capture delay, the weight value from the weight stream is captured.	Stable*   Immediate

Weight capture delay	Defines the time in seconds the balance waits for capturing the weight after the button to add the result was tapped or the add result was triggered by the automatic weighing result creation. This setting is only available if <b>Weight capture mode</b> is set to <b>Immediate</b> .	Numeric (5 seconds*   0...60 seconds)
----------------------	--	---------------------------------------

\* Factory setting

## Statistics

Parameter	Description	Values
Activate statistics	<p>If <b>Activate statistics</b> is set to <b>Active</b>, the following statistics will be calculated:</p> <p><b>Count:</b> Number of items used for the statistics</p> <p><b>Sum:</b> sum of all value (decimal places and unit according to the method settings)</p> <p><b>Minimum:</b> smallest value (decimal places and unit according to the method settings)</p> <p><b>Maximum:</b> largest value (decimal places and unit according to the method setting)</p> <p><b>Range:</b> difference between the largest and smallest values (decimal places and unit according to the method settings)</p> <p><b>Average:</b> The values are summed up and divided by the number of values, rounded to 1 digit more than the configured decimal places in the associated tolerance profile (unit according to the method settings).</p> <p><b>Standard deviation:</b> standard deviation rounded to 1 digit more than the configured decimal places in the associated tolerance profile (unit according to the method settings)</p> <p><b>Relative standard deviation:</b> relative standard deviation (rounded to 2 decimal places, in %)</p> <p>The statistical values are calculated and displayed as soon as a result is added or updated.</p>	Active   Inactive*

\* Factory setting

## Electrostatic

Parameter	Description	Values
Ionizer	Defines whether the ionizer is activated/deactivated.	Active   Inactive*
Detection	Activates or deactivates electrostatic detection (StaticDetect).	Active   Inactive*
Threshold	<p>Defines the maximum acceptable weighing error due to electrostatic charges.</p> <p>If the measured approximate weighing error is smaller or equal to the detection threshold, the StaticDetect state is <b>OK</b>.</p> <p>If the measured approximate weighing error is larger than the detection threshold, the StaticDetect state is <b>Not OK</b>.</p> <p>This setting is only available if <b>Detection</b> is set to <b>Active</b>.</p>	Numeric
Show weighing error	<p>Displays the weighing error or not.</p> <p><b>Active:</b> If the StaticDetect value is above the threshold, the effective approximate weighing error is displayed.</p> <p>This setting is only available if <b>Detection</b> is <b>Active</b>.</p>	Active*   Inactive

\* Factory setting

## See also

[Creating a method "General weighing" ▶ Page 40](#)

### 6.2.1.4 Weighing item / Weighing items

A target weight with tolerance limits can be defined for the method. The method **General weighing** includes a single item in **Weighing item**, whereas several items can be defined for the method **General weighing (itemized)** in **Weighing items**.

Parameter	Description	Values
Sample ID	Defines the name of the sample. This setting is only available for methods containing several weighing items (itemized).	Text (0...32 characters)
Unit	Defines the unit of the weighing result.	The available units depend on the balance model.
Target weight	Defines the target weight. The target weight will be shown in the weighing-in aid of the balance (SmartTrac). When a target weight including tolerances is defined, the SmartTrac indicates if the current display weight is in tolerance or not.	Numeric
-Tolerance	Defines the lower tolerance limit. This setting is only available if a <b>Target weight</b> is defined.	Numeric
+Tolerance	Defines the upper tolerance limit. This setting is only available if a <b>Target weight</b> is defined.	Numeric

## See also

[Creating a method "General weighing" ▶ Page 40](#)

### 6.2.1.5 Automation

Parameter	Description	Values
Barcode data target	If a barcode reader is connected to the balance, this option defines how the data is to be processed. <b>Keyboard Input:</b> The data is written in the currently open input window. If no input window is open, the data is ignored. <b>Target weight value:</b> The barcode data is interpreted as a value for the target weight. <b>Task ID 1:</b> The received barcode data is treated as identification text for this task ID. <b>Result ID 1:</b> The received barcode data is treated as identification text for this result ID. The available items in the drop-down menu depend on the <b>Number of task IDs</b> and <b>Number of result IDs</b> specified for the method. Make sure that the characters of the scanned barcode are compatible with the format of the field where they should be inserted.	Keyboard Input*   Target weight value   Task ID 1   Result ID 1   ...

\* Factory setting

## Automatic feeder support

When the parameter **Automatic feeder support** is activated, additional parameters can be defined to set up the automatic feeder LV12.

Parameter	Description	Values
Automatic feeder support	Enables or disables the automatic feeder support. To use the automatic feeder support, the automatic feeder has to be connected to the balance by USB and has to be configured correctly.	Active   Inactive*
Number of weighing items	Defines the number of items that the automatic feeder will deliver to the balance.	Numeric (20*   1...100)
Plausibility limits	Defines the plausibility limit for measured values. The plausibility limit relates to the defined target weight. Example: With a plausibility limit of 30%, all weight values that are within $\pm 30\%$ of the target weight are regarded as plausible and are transferred into the statistics. All other weight values are being ignored and excluded from the statistics.	Numeric (30%*   0...100%)
Discharge feeder at the end	Specifies if the automatic feeder is emptied of all objects after the task. <b>Active:</b> The automatic feeder feeds at the configured discharge feed rate and stops 90 seconds after the last object has passed the light barrier. <b>Inactive:</b> No automatic emptying.	Active   Inactive*
Feed rate	Defines the rate at which the automatic feeder delivers the items to the balance.	Slow   Normal*   Fast   Very fast

\* Factory setting

## Weighing automation

Parameter	Description	Values
Automatic zero	<b>Active:</b> the balance is automatically zeroed when the weight falls below a predefined threshold. This setting is not available for approved balances.	Active   Inactive*
Automatic zero threshold	Defines the threshold of the <b>Automatic zero</b> . This setting is only available if <b>Automatic zero</b> is set to <b>Active</b> .	Numeric
Tare Mode	Defines the tare mode. <b>None:</b> No automatic tare. <b>Automatic tare:</b> The balance stores automatically the first stable weight as the tare weight. <b>Preset tare:</b> Allows you to enter manually a numerical entry of a fixed tare weight.	None*   Automatic tare   Preset tare
Automatic tare threshold	Defines the threshold of the option <b>Tare Mode</b> . This value defines the minimum weight that must be applied to the weighing pan so that it is automatically stored as the tare weight. If the weight is below the limits, it is not automatically transferred to the tare memory. Instead of entering the weight, the lightest tare container can be placed on the weighing pan and the button  subsequently pressed. The applied weight is directly taken over as a limit. This setting is only available if <b>Tare Mode</b> is set to <b>Automatic tare</b> .	Numeric

Preset tare value	<p>Defines a weight value for the pretare function.</p> <p>Instead of entering the value, the respective tare container can be placed on the weighing pan and the button  subsequently pressed. The weight is directly taken over as pretare value.</p> <p>This setting is only available if <b>Tare Mode</b> is set to <b>Preset tare</b>.</p>	Numeric
Automatic result	<p>Automatically generates a weighing result after a threshold is reached.</p> <p><b>None:</b> No automatic result will be generated.</p> <p><b>With sample tare:</b> After a weight value that reached the threshold is being removed from the weighing pan, the balance is being tared.</p> <p><b>Without sample tare:</b> After a weight value that reached the threshold is being removed from the weighing pan, the balance is not being tared.</p> <p>If <b>Automatic feeder support</b> is activated, the setting <b>Automatic result</b> is automatically set to <b>Without sample tare</b> and cannot be edited.</p>	None   With sample tare*   Without sample tare
Automatic result threshold	<p>Defines the threshold of the <b>Automatic result</b>.</p> <p>The result is automatically added to the <b>Results list</b> only if the weight of the sample is larger than the defined threshold.</p> <p>This setting is only available if <b>Automatic result</b> is set to <b>Active</b>.</p>	Numeric
Weight trigger	<p>Defines the behaviour of the option <b>Automatic result threshold</b>.</p> <p><b>Exceeding:</b> The weighing result is generated when the weight exceeds the defined threshold.</p> <p><b>Falling below:</b> The weighing result is generated when the weight falls below the defined threshold.</p> <p>This setting is only available if <b>Automatic result</b> is set to <b>Without sample tare</b>.</p> <p>If <b>Automatic feeder support</b> is activated, the setting <b>Weight trigger</b> is automatically set to <b>Exceeding</b> and cannot be edited.</p>	Exceeding*   Falling below
Automatic tare after result	<p>If set to <b>Active</b>, the balance is automatically tared when a result is added to the <b>Results list</b>.</p>	Active   Inactive*
Automatic task completion	<p><b>Active:</b> the balance automatically completes a running task after the result of the last weighing item has been added to the <b>Results list</b>.</p> <p>This setting is only available if the method is using multiple weighing items.</p>	Active   Inactive*

\* Factory setting

#### See also

 [Creating a method "General weighing" ▶ Page 40](#)

### 6.2.1.6 Print / Export

Parameter	Description	Values
Strip printout and data export	<p>Defines the content of the printout and/or export, as well as which printing/exporting actions are performed automatically when the task is complete.</p> <p>This section contains several settings that are described in the table <b>Strip printout and data export</b> below.</p>	

Label printout for task	Defines the template of the task label to be printed, i.e., which data is included on the label and in which format. This section contains several settings that are described in the table <b>Label printout for task</b> below.	
Label printout for weighing item	Defines the template of the weighing item label to be printed, i.e., which data is included on the label and in which format. This section contains several settings that are described in the table <b>Label printout for weighing item</b> below.	
Label cutting	Defines if the labels should be cut after printing. <b>Per label:</b> Each label is cut once printed. <b>Per task:</b> The labels are cut when the task is complete. This setting is only relevant if the connected label printer can cut labels.	Off*   Per label   Per task

\* Factory setting

### 6.2.1.6.1 Strip printout and data export

#### Automatic data output

Parameter	Description	Values
Strip printer	Activates/Deactivates automatic printing of the <b>Results list</b> on a strip printer when the <b>Complete</b> button is tapped. The data to be transmitted to the printer can be defined in the section <b>Template settings</b> .	Active   Inactive*
Results export	Activates/Deactivates the automatic data export to a file server or USB storage device when the <b>Complete</b> button is tapped.	Active   Inactive*
Weight value	Activates/Deactivates the option to automatically send the weighing value over USB or Ethernet when tapping <b>Add result</b> .	Active   Inactive*

\* Factory setting

#### Strip printout template

This menu item can be used to define which information is printed by the strip printer.

Each individual parameter can be set to **Inactive** or **Active** via the corresponding check box. To enable or disable all parameters at once, proceed as follows:

- To disable all check boxes at once, tap  **Deselect all**.  
➔ All parameters are set to **Inactive**.
- To enable all check boxes at once, tap  **Select all**.  
➔ All parameters are set to **Active**.

#### Template settings

Parameter	Description	Values
Header and Footer	Defines the header and/or footer to be printed.	Title   Title text   Date/time   User   Signature   Separating lines   Group titles
Balance information	Defines which information about the balance is printed.	Balance type   Balance ID   Balance serial number   Software version

Quality information	Defines which quality information is printed.	Tolerance profile   Adjustment date/time   Routine test name   Routine test last execution date   Routine test result   GWP   Approved state   Level state   MinWeigh state
Task information	Defines which information about the task is printed.	Method name   Method comment   Task IDs   Custom unit settings   Automatic result settings   Count   Sum   Average   Minimum   Maximum   Range   Standard deviation   Relative standard deviation
Weighing item information	Defines which information about the weighing items is printed.	Show excluded weighing items   Result state   Result IDs   GWP   Approved state   Electrostatic charge   Level state   MinWeigh state   Tolerance state   Target and tolerances
Result detail information	Defines which information related to the result of the measurement is printed.	Weight   Tare weight   Gross weight   Info weight   Date/time   Stability

#### 6.2.1.6.2 Label printout for task

Parameter	Description	Values
Automatic label printout for task	When set to <b>Active</b> , the task label is automatically printed when tapping <b>Complete</b> .	Active   Inactive*
Copies	Defines how many copies of the label are printed.	Numeric
Used template	Chooses the label template.	Available labels are shown below.

\* Factory setting

#### Field settings

The content of each label field can be defined individually.

Parameter	Description	Values
Label field 1	Defines which information appears in each label field. The number of label fields depends on the selected template.	Available entries depend on the method settings.

#### Barcode settings

The content of each barcode field can be defined individually. This section is only available when the selected **Used template** contains at least one 2D code.

Parameter	Description	Values
Delimiter	Defines the delimiter between the barcode entries. This setting is only available when the selected <b>Used template</b> contains several 2D codes.	TAB*   Form feed   Carriage return   Space   User defined

Barcode field 1	Defines which information appears in each barcode. The number of the barcode fields depends on the selected template.	Available entries depend on the method settings.
-----------------	---	--

\* Factory setting

### 6.2.1.6.3 Label printout for weighing item

Parameter	Description	Values
Automatic label printout for weighing item	When set to <b>Active</b> , the weighing item label is automatically printed when tapping <b>Add result</b> .	Active   Inactive*
Copies	Defines how many copies of the label are printed.	Numeric
Used template	Chooses the label template.	Available labels are shown below.

\* Factory setting

#### Field settings

The content of each label field can be defined individually.

Parameter	Description	Values
Label field 1	Defines which information appears in each label field. The number of label fields depends on the selected template.	Available entries depend on the method settings.

#### Barcode settings

The content of each barcode field can be defined individually. This section is only available when the selected **Used template** contains at least one 2D code.

Parameter	Description	Values
Delimiter	Defines the delimiter between the barcode entries. This setting is only available when the selected <b>Used template</b> contains several 2D codes.	TAB*   Form feed   Carriage return   Space   User defined
Barcode field 1	Defines which information appears in each barcode. The number of the barcode fields depends on the selected template.	Available entries depend on the method settings.

\* Factory setting

### 6.2.1.6.4 Available labels

The following label layouts can be selected:

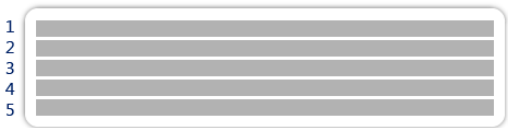
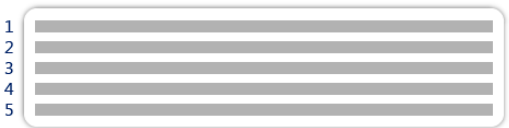
 <p>5 large fields</p>	 <p>5 small fields</p>
 <p>10 small fields</p>	 <p>1D barcode with 3 large fields</p>

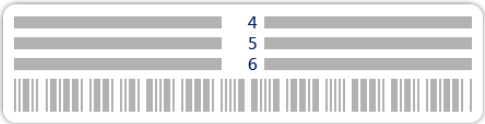
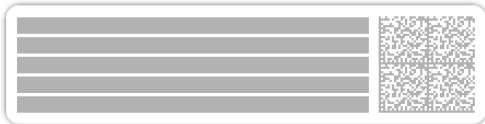
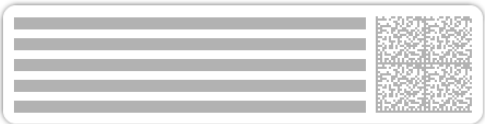
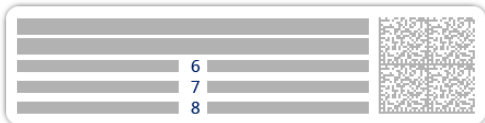
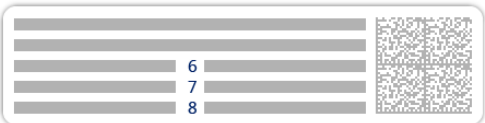

 <p>1 2 3</p> <p>1D barcode with 3 small fields</p>	 <p>1 2 3</p> <p>4 5 6</p> <p>1D barcode with 6 small fields</p>
 <p>1 2 3 4 5</p> <p>2D barcode with 5 large fields</p>	 <p>1 2 3 4 5</p> <p>2D barcode with 5 small fields</p>
 <p>1 2 3 4 5</p> <p>6 7 8</p> <p>2D barcode with 2 large fields and 6 small fields</p>	 <p>1 2 3 4 5</p> <p>6 7 8</p> <p>2D barcode with 8 small fields</p>

## 6.2.2 Settings: method "Simple formulation"

Navigation: ▾ Methods > ☰] Methods list > 🗑️ my simple formulation > ✎ Edit

The settings of the method **Simple formulation** are grouped as follows:

- ☰] **General**
- 🗑️ **Formulation**
- 🗑️ **ID format**
- ⚖️ **Weighing**
- ⚖️ **Weighing item**, only available for the method **Simple formulation**
- ⚖️ **Weighing items**, only available for the method **Simple formulation (itemized)**
- ⚙️ **Automation**
- 🖨️ **Print / Export**

### See also

- 🔗 [Creating a method "Simple formulation" ▶ Page 42](#)
- 🔗 [Editing a method ▶ Page 63](#)

### 6.2.2.1 General

The **Method type** is defined in the wizard while creating the method and cannot be changed.

Parameter	Description	Values
Method name	Defines the name of the method.	Text (1...22 characters)
Comment	The method can be described with a comment.	Text (0...128 characters)
Lock method	Locks the method to prevent further editing.	Active   Inactive*

\* Factory setting

### 6.2.2.2 Formulation

Parameter	Description	Values
Calculate target	<p>Defines the basis for the calculation of the target weight.</p> <p><b>Flask volume:</b> Calculates the target weight according to the reference flask volume and the actual flask volume.</p> <p><b>Target concentration:</b> Calculates the target weight according to the desired target concentration.</p> <p>This setting is only available for methods of the type <b>Simple formulation (itemized)</b>.</p>	None*   Flask volume   Target concentration

Calculate concentration per component	<p>Calculates the concentration of the final solution.</p> <p>If <b>Concentration unit</b> represents a molar concentration (<b>mol/l</b> or <b>mmol/l</b>), the calculation is based on:</p> <ul style="list-style-type: none"> <li>• <b>Purity</b></li> <li>• <b>Reference flask volume</b></li> <li>• <b>Molar mass</b></li> <li>• weight of the component</li> </ul> <p>If <b>Concentration unit</b> represents a mass concentration (<b>mg/ml</b>, <b>mg/l</b>, <b>µg/ml</b>, <b>g/ml</b>, or <b>g/l</b>), the calculation is based on:</p> <ul style="list-style-type: none"> <li>• <b>Purity</b></li> <li>• <b>Reference flask volume</b></li> <li>• weight of the component</li> </ul> <p>If <b>Concentration unit</b> represents a mass ratio (%), the calculation is based on:</p> <ul style="list-style-type: none"> <li>• <b>Purity</b></li> <li>• <b>Reference weight</b></li> <li>• weight of the component</li> </ul>	Active   Inactive*
Calculate amount of component	Calculates the amount of component (in <b>mol</b> ) based on the <b>Molar mass</b> and weight of component.	Active   Inactive*
Concentration unit	<p>Defines the concentration unit.</p> <p>This setting is only available if <b>Calculate concentration per component</b> is set to <b>Active</b>.</p>	mol/l*   mmol/l   mg/ml   mg/l   µg/ml   g/ml   g/l   %
Reference flask volume	<p>Defines the volume of the reference flask.</p> <p>This setting is only available if <b>Concentration unit</b> is not set to %.</p>	Numeric (1 ml*   1...999999 ml)
Reference weight (100%)	<p>Defines the reference weight for the calculation of concentration of the component.</p> <p>Instead of entering the reference weight manually, place the reference weight on the weighing pan and tap the button . The applied weight is directly taken over as a reference weight.</p> <p>This setting is only available if <b>Concentration unit</b> is set to %.</p>	Depending on the capacity of the balance.

\* Factory setting

### Production and expiry date

Parameter	Description	Values
Production date	<p>Defines the production date.</p> <p><b>Current date:</b> The production date is set automatically to the date when starting the weighing task.</p> <p><b>Manual input:</b> The production date can be entered manually when starting the weighing task.</p>	None   Current date*   Manual input
Expiry date	<p>Defines the expiry date of the substance.</p> <p><b>Period:</b> The expiry date is set automatically when starting the weighing task (expiry date = date when starting the weighing task + number of days defined in the field <b>Period</b>).</p> <p><b>Manual input:</b> The expiry date can be entered manually when starting the weighing task.</p>	None*   Period   Manual input
Period	<p>Defines the period of the expiry date.</p> <p>This setting is only available if <b>Expiry date</b> is set to <b>Period</b>.</p>	Numeric (1 day*   1...9999 days)

\* Factory setting

## See also

 [Creating a method "Simple formulation" ▶ Page 42](#)

### 6.2.2.3 ID format

#### Task IDs

Parameter	Description	Values
Number of task IDs	Defines the number of task IDs. If the <b>Number of task IDs</b> is larger than 0, the settings <b>Task ID</b> , <b>Task description</b> and <b>Prefix/Default value</b> are available for every single task ID.	0   1*   2   3
Task ID 1	Defines the naming type of the task ID. <b>Manual with default:</b> The value of the task ID can be entered manually at method execution time. <b>Automatic timestamp:</b> The system provides a value created from a prefix with the current date and time appended.	Manual with default*   Automatic timestamp
Task description	Allows to define a label for each task ID field.	Text (0...32 characters)
Default value	Defines a default value for the task ID. The value of the task ID can be changed manually while executing the method. This setting is only available when the corresponding <b>Task ID</b> is set to <b>Manual with default</b> .	Text (0...32 characters)
Prefix	Defines a prefix for the task ID. This setting is only available is the corresponding <b>Task ID</b> is set to <b>Automatic timestamp</b> .	Text (0...32 characters)

\* Factory setting

#### Result IDs

Parameter	Description	Values
Number of result IDs	Defines the number of result IDs. If the <b>Number of result IDs</b> is larger than 0, the settings <b>Result ID</b> , <b>Result description</b> and <b>Prefix/Default value</b> are available for every single result ID.	0   1*   2   3
Result ID 1	Defines the naming type of the result ID. <b>Manual with default:</b> The value of the result ID can be entered manually at method execution time. <b>Automatic counter:</b> The system provides a value created from a <b>Prefix</b> to which is appended a unique number (counter).	Manual with default*   Automatic counter
Result description	Allows to define a label for each result ID.	Text (0...32 characters)
Default value	Defines a default value for the result ID. The value of the result ID can be changed manually while executing the method. This setting is only available when the corresponding <b>Result ID</b> is set to <b>Manual with default</b> .	Text (0...32 characters)
Prefix	Defines a prefix for the result ID. This setting is only available if the corresponding <b>Result ID</b> is set to <b>Automatic counter</b> .	Text (0...32 characters)

\* Factory setting

### 6.2.2.4 Weighing

Parameter	Description	Values
Show info weight	When set to <b>Active</b> , a secondary weight is displayed on the weighing screen.	Active   Inactive*
Info unit	Defines the unit of the <b>Info weight</b> . This setting is only available if <b>Show info weight</b> is set to <b>Active</b> .	The available units depend on the balance model.

\* Factory setting

#### Weighing settings

Parameter	Description	Values
Tolerance profile	A tolerance profile stores all the necessary balance settings needed for a certain weighing method. It is possible to create different tolerance profiles for different weighing methods.	Tolerance profiles are created by the user for specific balances and applications.

#### Electrostatic

Parameter	Description	Values
Ionizer	Defines whether the ionizer is activated/deactivated.	Active   Inactive*
Detection	Activates or deactivates electrostatic detection (StaticDetect).	Active   Inactive*
Threshold	Defines the maximum acceptable weighing error due to electrostatic charges. If the measured approximate weighing error is smaller or equal to the detection threshold, the StaticDetect state is <b>OK</b> . If the measured approximate weighing error is larger than the detection threshold, the StaticDetect state is <b>Not OK</b> . This setting is only available if <b>Detection</b> is set to <b>Active</b> .	Numeric
Show weighing error	Displays the weighing error or not. <b>Active:</b> If the StaticDetect value is above the threshold, the effective approximate weighing error is displayed. This setting is only available if <b>Detection</b> is <b>Active</b> .	Active*   Inactive

\* Factory setting

#### See also

 [Creating a method "Simple formulation" ▶ Page 42](#)

### 6.2.2.5 Weighing item

A target weight with tolerance limits can be defined for the method. The method **Simple formulation** includes a single item in **Weighing item**, whereas several items can be defined for the method **Simple formulation (itemized)** in **Weighing items**.

#### Initial values for weighing

Parameter	Description	Values
Molar mass	Defines the molar mass of the component. The molar mass of an ion is calculated by adding the atomic weight of the individual atoms the ion is composed of. This setting is available if <b>Calculate amount of component</b> is set to <b>Active</b> or if the <b>Concentration unit</b> is expressed in molar concentration.	Numeric (1 ... 10000 g/mol)

Purity	To define the purity of the component. This setting is only available if <b>Calculate concentration per component</b> or <b>Calculate amount of component</b> is set to <b>Active</b> .	Numeric (100%*   0.001...100%)
Unit	Defines the unit of the weighing result.	The available units depend on the balance model.
Target weight	Defines the target weight. The target weight will be shown in the weighing-in aid of the balance (SmartTrac). When a target weight including tolerances is defined, the SmartTrac indicates if the current display weight is in tolerance or not.	Numeric
-Tolerance	Defines the lower tolerance limit. This setting is only available if a <b>Target weight</b> is defined.	Numeric
+Tolerance	Defines the upper tolerance limit. This setting is only available if a <b>Target weight</b> is defined.	Numeric

\* Factory setting

### See also

 [Creating a method "Simple formulation" ▶ Page 42](#)

## 6.2.2.6 Weighing items

This section is only available for the method **Simple formulation (itemized)**.

Parameter	Description	Values
Component ID	Defines the name of the component.	Text (0...32 characters)
Molar mass	Defines the molar mass of the component. The molar mass of an ion is calculated by adding the atomic weight of the individual atoms the ion is composed of. This setting is available if <b>Calculate amount of component</b> is set to <b>Active</b> or if the <b>Concentration unit</b> is expressed in molar concentration.	Numeric (1...10000 g/mol)
Purity	To define the purity of the component. This setting is only available if <b>Calculate concentration per component</b> or <b>Calculate amount of component</b> is set to <b>Active</b> .	Numeric (100%*   0.001...100%)
Unit	Defines the unit of the weighing result.	The available units depend on the balance model.
Target weight	Defines the target weight of the component. If <b>Calculate target</b> is set to <b>Target concentration</b> , the <b>Target weight</b> is calculated and cannot be edited manually.	Numeric
Target concentration	Defines the target concentration of the component. This setting is only available if <b>Calculate target</b> is set to <b>Target concentration</b> .	Numeric (0%   0.001...100%)
-Tolerance	Defines the lower tolerance limit. This setting is only available if a <b>Target weight</b> or <b>Target concentration</b> is defined.	Numeric
+Tolerance	Defines the upper tolerance limit. This setting is only available if a <b>Target weight</b> or <b>Target concentration</b> is defined.	Numeric

\* Factory setting

## See also

 Creating a method "Simple formulation" ▶ Page 42

 Using methods with multiple weighing items (itemized) ▶ Page 64

### 6.2.2.7 Automation

Parameter	Description	Values
Barcode data target	<p>If a barcode reader is connected to the balance, this option defines how the data is to be processed.</p> <p><b>Keyboard Input:</b> The data is written in the currently open input window. If no input window is open, the data is ignored.</p> <p><b>Target weight value:</b> The barcode data is interpreted as a value for the target weight.</p> <p><b>Task ID 1:</b> The received barcode data is treated as identification text for this task ID.</p> <p><b>Result ID 1:</b> The received barcode data is treated as identification text for this result ID.</p> <p>The available items in the drop-down menu depend on the <b>Number of task IDs</b> and <b>Number of result IDs</b> specified for the method.</p> <p>Make sure that the characters of the scanned barcode are compatible with the format of the field where they should be inserted.</p>	Keyboard Input*   Target weight value   Task ID 1   Result ID 1   ...

\* Factory setting

### Weighing automation

Parameter	Description	Values
Automatic zero	<p><b>Active:</b> the balance is automatically zeroed when the weight falls below a predefined threshold.</p> <p>This setting is not available for approved balances.</p>	Active   Inactive*
Automatic zero threshold	<p>Defines the threshold of the <b>Automatic zero</b>.</p> <p>This setting is only available if <b>Automatic zero</b> is set to <b>Active</b>.</p>	Numeric
Tare Mode	<p>Defines the tare mode.</p> <p><b>None:</b> No automatic tare.</p> <p><b>Automatic tare:</b> The balance stores automatically the first stable weight as the tare weight.</p> <p><b>Preset tare:</b> Allows you to enter manually a numerical entry of a fixed tare weight.</p>	None*   Automatic tare   Preset tare
Automatic tare threshold	<p>Defines the threshold of the option <b>Tare Mode</b>.</p> <p>This value defines the minimum weight that must be applied to the weighing pan so that it is automatically stored as the tare weight. If the weight is below the limits, it is not automatically transferred to the tare memory.</p> <p>Instead of entering the weight, the lightest tare container can be placed on the weighing pan and the button  subsequently pressed. The applied weight is directly taken over as a limit.</p> <p>This setting is only available if <b>Tare Mode</b> is set to <b>Automatic tare</b>.</p>	Numeric

Preset tare value	Defines a weight value for the pretare function. Instead of entering the value, the respective tare container can be placed on the weighing pan and the button  subsequently pressed. The weight is directly taken over as pretare value. This setting is only available if <b>Tare Mode</b> is set to <b>Preset tare</b> .	Numeric
Automatic tare after result	If set to <b>Active</b> , the balance is automatically tared when a result is added to the <b>Results list</b> .	Active   Inactive*
Automatic task completion	<b>Active</b> : the balance automatically completes a running task after the result of the last weighing item has been added to the <b>Results list</b> . This setting is only available if the method is using multiple weighing items.	Active   Inactive*

\* Factory setting

### See also

 [Creating a method "Simple formulation" ▶ Page 42](#)

## 6.2.2.8 Print / Export

Parameter	Description	Values
Strip printout and data export	Defines the content of the printout and/or export, as well as which printing/exporting actions are performed automatically when the task is complete. This section contains several settings that are described in the table <b>Strip printout and data export</b> below.	
Label printout for task	Defines the template of the task label to be printed, i.e., which data is included on the label and in which format. This section contains several settings that are described in the table <b>Label printout for task</b> below.	
Label printout for weighing item	Defines the template of the weighing item label to be printed, i.e., which data is included on the label and in which format. This section contains several settings that are described in the table <b>Label printout for weighing item</b> below.	
Label cutting	Defines if the labels should be cut after printing. <b>Per label</b> : Each label is cut once printed. <b>Per task</b> : The labels are cut when the task is complete. This setting is only relevant if the connected label printer can cut labels.	Off*   Per label   Per task

\* Factory setting

### 6.2.2.8.1 Strip printout and data export

#### Automatic data output

Parameter	Description	Values
Strip printer	Activates/Deactivates automatic printing of the <b>Results list</b> on a strip printer when the <b>Complete</b> button is tapped. The data to be transmitted to the printer can be defined in the section <b>Template settings</b> .	Active   Inactive*
Results export	Activates/Deactivates the automatic data export to a file server or USB storage device when the <b>Complete</b> button is tapped.	Active   Inactive*



Weight value	Activates/Deactivates the option to automatically send the weighing value over USB or Ethernet when tapping <b>Add result</b> .	Active   Inactive*
--------------	---	--------------------

\* Factory setting

### Strip printout template

This menu item can be used to define which information is printed by the strip printer.

Each individual parameter can be set to **Inactive** or **Active** via the corresponding check box. To enable or disable all parameters at once, proceed as follows:

- To disable all check boxes at once, tap  **Deselect all**.
  - ➔ All parameters are set to **Inactive**.
- To enable all check boxes at once, tap  **Select all**.
  - ➔ All parameters are set to **Active**.

### Template settings

Parameter	Description	Values
Header and Footer	Defines the header and/or footer to be printed.	Title   Title text   Date/time   User   Signature   Separating lines   Group titles
Balance information	Defines which information about the balance is printed.	Balance type   Balance ID   Balance serial number   Software version
Quality information	Defines which quality information is printed.	Tolerance profile   Adjustment date/time   Routine test name   Routine test last execution date   Routine test result   GWP Approved state   Level state   MinWeigh state
Task information	Defines which information about the task is printed.	Method name   Method comment   Task ID   Flask volume   Reference weight   Expiry date   Production date
Weighing item information	Defines which information about the weighing items is printed.	Show excluded weighing items   Result state   Result IDs   Molar mass   Purity   Amount of substance   Concentration   GWP Approved state   Level state   MinWeigh state   Tolerance state   Target and tolerances
Result detail information	Defines which information related to the result of the measurement is printed.	Weight   Tare weight   Gross weight   Info weight   Date/time   Stability

### 6.2.2.8.2 Label printout for task

Parameter	Description	Values
Automatic label printout for task	When set to <b>Active</b> , the task label is automatically printed when tapping <b>Complete</b> .	Active   Inactive*
Copies	Defines how many copies of the label are printed.	Numeric
Used template	Chooses the label template.	Available labels are shown below.

\* Factory setting

#### Field settings

The content of each label field can be defined individually.

Parameter	Description	Values
Label field 1	Defines which information appears in each label field. The number of label fields depends on the selected template.	Available entries depend on the method settings.

#### Barcode settings

The content of each barcode field can be defined individually. This section is only available when the selected **Used template** contains at least one 2D code.

Parameter	Description	Values
Delimiter	Defines the delimiter between the barcode entries. This setting is only available when the selected <b>Used template</b> contains several 2D codes.	TAB*   Form feed   Carriage return   Space   User defined
Barcode field 1	Defines which information appears in each barcode. The number of the barcode fields depends on the selected template.	Available entries depend on the method settings.

\* Factory setting

### 6.2.2.8.3 Label printout for weighing item

Parameter	Description	Values
Automatic label printout for weighing item	When set to <b>Active</b> , the weighing item label is automatically printed when tapping <b>Add result</b> .	Active   Inactive*
Copies	Defines how many copies of the label are printed.	Numeric
Used template	Chooses the label template.	Available labels are shown below.

\* Factory setting

#### Field settings

The content of each label field can be defined individually.

Parameter	Description	Values
Label field 1	Defines which information appears in each label field. The number of label fields depends on the selected template.	Available entries depend on the method settings.

#### Barcode settings

The content of each barcode field can be defined individually. This section is only available when the selected **Used template** contains at least one 2D code.







Parameter	Description	Values
Delimiter	Defines the delimiter between the barcode entries. This setting is only available when the selected <b>Used template</b> contains several 2D codes.	TAB*   Form feed   Carriage return   Space   User defined

Barcode field 1	Defines which information appears in each barcode. The number of the barcode fields depends on the selected template.	Available entries depend on the method settings.
-----------------	---	--

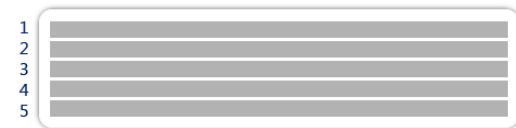
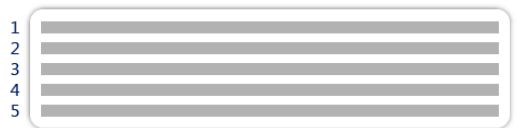
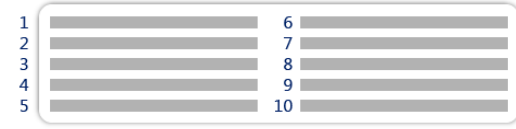
\* Factory setting

#### 6.2.2.8.4 Available labels

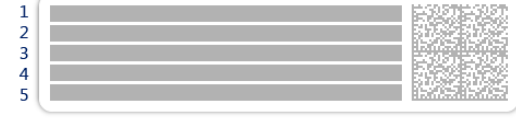
The following label layouts can be selected:

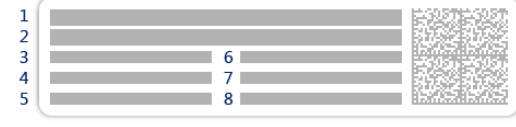
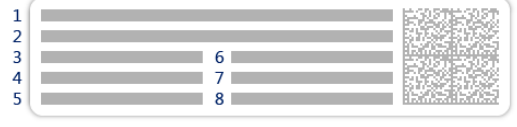
 <p>1 2 3 4 5</p> <p>5 large fields</p>	 <p>1 2 3 4 5</p> <p>5 small fields</p>
 <p>1 2 3 4 5</p> <p>6 7 8 9 10</p> <p>10 small fields</p>	 <p>1 2 3</p> <p>1D barcode with 3 large fields</p>
 <p>1 2 3</p> <p>1D barcode with 3 small fields</p>	 <p>1 2 3</p> <p>4 5 6</p> <p>1D barcode with 6 small fields</p>
 <p>1 2 3 4 5</p> <p>2D barcode with 5 large fields</p>	 <p>1 2 3 4 5</p> <p>2D barcode with 5 small fields</p>
 <p>1 2 3 4 5</p> <p>6 7 8</p> <p>2D barcode with 2 large fields and 6 small fields</p>	 <p>1 2 3 4 5</p> <p>6 7 8</p> <p>2D barcode with 8 small fields</p>

## 6.2.3 Settings: method "Interval weighing"

Navigation: ▼ Methods > ≡ Methods list > Ⓞ my interval weighing > ✎ Edit

✎ Edit method - my interval weighing

General	Method type	Interval weighing
Interval	Method name	my interval weighing
ID format	Comment	<i>Enter here</i>
Weighing		
Weighing item	Lock method	<input type="checkbox"/>
Automation		
Print / Export		

← Close
✓ Save

The settings of the method **Interval weighing** are grouped as follows:

- ≡ General
- Ⓞ Interval
- ID ID format
- ⚙ Weighing
- ⚙ Weighing item
- Ⓞ Automation
- 🖨 Print / Export

### See also

- 🔗 [Creating a method "Interval weighing" ▶ Page 43](#)
- 🔗 [Editing a method ▶ Page 63](#)

### 6.2.3.1 General

The **Method type** is defined in the wizard while creating the method and cannot be changed.

Parameter	Description	Values
Method name	Defines the name of the method.	Text (1...22 characters)
Comment	The method can be described with a comment.	Text (0...128 characters)
Lock method	Locks the method to prevent further editing.	Active   Inactive*

\* Factory setting

### 6.2.3.2 Interval

Parameter	Description	Values
Approximate interval	Defines the duration of a single weighing interval.	Numeric (1 s*   0.5...60 s)
Measurements	Defines the total number of measurements.	Numeric (3600*   1...5000)

\* Factory setting

#### i Note

The parameter **Duration** shows the duration of the method based on the values defined for the parameters **Approximate interval** and **Measurements**.

## See also

[Creating a method "Interval weighing" ▶ Page 43](#)

### 6.2.3.3 ID format

#### Task IDs

Parameter	Description	Values
Number of task IDs	Defines the number of task IDs. If the <b>Number of task IDs</b> is larger than 0, the settings <b>Task ID</b> , <b>Task description</b> and <b>Prefix/Default value</b> are available for every single task ID.	0   1*   2   3
Task ID 1	Defines the naming type of the task ID. <b>Manual with default:</b> The value of the task ID can be entered manually at method execution time. <b>Automatic timestamp:</b> The system provides a value created from a prefix with the current date and time appended.	Manual with default*   Automatic timestamp
Task description	Allows to define a label for each task ID field.	Text (0...32 characters)
Default value	Defines a default value for the task ID. The value of the task ID can be changed manually while executing the method. This setting is only available when the corresponding <b>Task ID</b> is set to <b>Manual with default</b> .	Text (0...32 characters)
Prefix	Defines a prefix for the task ID. This setting is only available is the corresponding <b>Task ID</b> is set to <b>Automatic timestamp</b> .	Text (0...32 characters)

\* Factory setting

### 6.2.3.4 Weighing

Parameter	Description	Values
Show info weight	When set to <b>Active</b> , a secondary weight is displayed on the weighing screen.	Active   Inactive*
Info unit	Defines the unit of the <b>Info weight</b> . This setting is only available if <b>Show info weight</b> is set to <b>Active</b> .	The available units depend on the balance model.

\* Factory setting

#### Weighing settings

Parameter	Description	Values
Tolerance profile	A tolerance profile stores all the necessary balance settings needed for a certain weighing method. It is possible to create different tolerance profiles for different weighing methods.	Tolerance profiles are created by the user for specific balances and applications.

## See also

[Creating a method "Interval weighing" ▶ Page 43](#)

### 6.2.3.5 Weighing item

#### Initial values for weighing

Parameter	Description	Values
Unit	Defines the unit of the weighing result.	The available units depend on the balance model.

#### See also

 [Creating a method "Interval weighing" ▶ Page 43](#)

### 6.2.3.6 Automation

Parameter	Description	Values
Barcode data target	<p>If a barcode reader is connected to the balance, this option defines how the data is to be processed.</p> <p><b>Keyboard Input:</b> The data is written in the currently open input window. If no input window is open, the data is ignored.</p> <p><b>Task ID 1:</b> The received barcode data is treated as identification text for this task ID.</p> <p>The available items in the drop-down menu depend on the <b>Number of task IDs</b> specified for the method.</p> <p>Make sure that the characters of the scanned barcode are compatible with the format of the field where they should be inserted.</p>	Keyboard Input*   Task ID 1   ...

\* Factory setting

#### See also

 [Creating a method "Interval weighing" ▶ Page 43](#)

### 6.2.3.7 Print / Export

Parameter	Description	Values
Strip printout and data export	<p>Defines the content of the printout and/or export, as well as which printing/exporting actions are performed automatically when the task is complete.</p> <p>This section contains several settings that are described in the table <b>Strip printout and data export</b> below.</p>	

#### 6.2.3.7.1 Strip printout and data export

##### Automatic data output

Parameter	Description	Values
Results export	Activates/Deactivates the automatic data export to a file server or USB storage device when the <b>Complete</b> button is tapped.	Active   Inactive*

\* Factory setting

## 6.2.4 Settings: method "Titration"

Navigation: ▼ Methods > ☰ Methods list > 🔍 my titration > ✎ Edit

The settings of the method **Titration** are grouped as follows:

- ☰ **General**
- 🔍 **Titration**
- 🆔 **ID format**
- ⚙️ **Weighing**
- 🧪 **Weighing item**
- ⚙️ **Automation**
- 🖨️ **Print / Export**

### See also

- 🔗 [Creating a method "Titration" ▶ Page 44](#)
- 🔗 [Editing a method ▶ Page 63](#)

### 6.2.4.1 General

The **Method type** is defined in the wizard while creating the method and cannot be changed.

Parameter	Description	Values
Method name	Defines the name of the method.	Text (1...22 characters)
Comment	The method can be described with a comment.	Text (0...128 characters)
Lock method	Locks the method to prevent further editing.	Active   Inactive*

\* Factory setting

### 6.2.4.2 Titration

Parameter	Description	Values
RFID option	Defines the behavior of the RFID reader. <b>Write only:</b> The RFID reader can only write content on the RFID tag. <b>Read and write:</b> The RFID reader can read the content of the RFID tag and write data on the RFID tag.	Inactive*   Write only   Read and write
Density	Defines the density of the liquid. This setting is only available if <b>RFID option</b> is set to <b>Write only</b> or <b>Read and write</b> .	Numeric (1.0000 g/ml*   0...100 g/ml)

Correction factor	Defines the titration correction factor. This setting is only available if <b>RFID option</b> is set to <b>Write only</b> or <b>Read and write</b> .	Numeric (1.0000* 1 0...1000000)
-------------------	---	---------------------------------

\* Factory setting

### See also

 [Creating a method "Titration" ▶ Page 44](#)

## 6.2.4.3 ID format

### Task IDs

Parameter	Description	Values
Number of task IDs	Defines the number of task IDs. If the <b>Number of task IDs</b> is larger than 0, the settings <b>Task ID</b> , <b>Task description</b> and <b>Prefix/Default value</b> are available for every single task ID.	0   1 *   2   3
Task ID 1	Defines the naming type of the task ID. <b>Manual with default:</b> The value of the task ID can be entered manually at method execution time. <b>Automatic timestamp:</b> The system provides a value created from a prefix with the current date and time appended.	Manual with default*   Automatic timestamp
Default value	Defines a default value for the task ID. The value of the task ID can be changed manually while executing the method. This setting is only available when the corresponding <b>Task ID</b> is set to <b>Manual with default</b> .	Text (0...32 characters)
Prefix	Defines a prefix for the task ID. This setting is only available is the corresponding <b>Task ID</b> is set to <b>Automatic timestamp</b> .	Text (0...32 characters)

\* Factory setting

### Result IDs

Parameter	Description	Values
Number of result IDs	Defines the number of result IDs. If the <b>Number of result IDs</b> is larger than 0, the settings <b>Result ID</b> , <b>Result description</b> and <b>Prefix/Default value</b> are available for every single result ID.	0   1 *   2   3
Result ID 1	Defines the naming type of the result ID. <b>Manual with default:</b> The value of the result ID can be entered manually at method execution time. <b>Automatic counter:</b> The system provides a value created from a <b>Prefix</b> to which is appended a unique number (counter).	Manual with default*   Automatic counter
Result description	Allows to define a label for each result ID.	Text (0...32 characters)
Default value	Defines a default value for the result ID. The value of the result ID can be changed manually while executing the method. This setting is only available when the corresponding <b>Result ID</b> is set to <b>Manual with default</b> .	Text (0...32 characters)
Prefix	Defines a prefix for the result ID. This setting is only available if the corresponding <b>Result ID</b> is set to <b>Automatic counter</b> .	Text (0...32 characters)

\* Factory setting



**i Note**

The maximum text length of the **Sample ID** is 32 characters. If the RFID option activated, only the first 20 characters are transferred to the RFID tag.

#### 6.2.4.4 Weighing

Parameter	Description	Values
Show info weight	When set to <b>Active</b> , a secondary weight is displayed on the weighing screen.	Active   Inactive*
Info unit	Defines the unit of the <b>Info weight</b> . This setting is only available if <b>Show info weight</b> is set to <b>Active</b> .	The available units depend on the balance model.

\* Factory setting

#### Weighing settings

Parameter	Description	Values
Tolerance profile	A tolerance profile stores all the necessary balance settings needed for a certain weighing method. It is possible to create different tolerance profiles for different weighing methods.	Tolerance profiles are created by the user for specific balances and applications.
Weight capture mode	Defines the behavior when the button to add the result was tapped or the add result was triggered by the automatic weighing result creation. <b>Stable</b> : The system waits for a stable weight. <b>Immediate</b> : The system doesn't wait for a stable weight. The system waits for the defined amount of seconds ( <b>Weight capture delay</b> ). After the weight capture delay, the weight value from the weight stream is captured.	Stable*   Immediate
Weight capture delay	Defines the time in seconds the balance waits for capturing the weight after the button to add the result was tapped or the add result was triggered by the automatic weighing result creation. This setting is only available if <b>Weight capture mode</b> is set to <b>Immediate</b> .	Numeric (5 seconds*   0...60 seconds)

\* Factory setting

#### Electrostatic

Parameter	Description	Values
Ionizer	Defines whether the ionizer is activated/deactivated.	Active   Inactive*
Detection	Activates or deactivates electrostatic detection (StaticDetect).	Active   Inactive*
Threshold	Defines the maximum acceptable weighing error due to electrostatic charges. If the measured approximate weighing error is smaller or equal to the detection threshold, the StaticDetect state is <b>OK</b> . If the measured approximate weighing error is larger than the detection threshold, the StaticDetect state is <b>Not OK</b> . This setting is only available if <b>Detection</b> is set to <b>Active</b> .	Numeric
Show weighing error	Displays the weighing error or not. <b>Active</b> : If the StaticDetect value is above the threshold, the effective approximate weighing error is displayed. This setting is only available if <b>Detection</b> is <b>Active</b> .	Active*   Inactive

\* Factory setting

## See also

[Creating a method "Titration" ▶ Page 44](#)

### 6.2.4.5 Weighing item

#### Initial values for weighing

Parameter	Description	Values
Unit	Defines the unit of the weighing result.	The available units depend on the balance model.
Target weight	Defines the target weight. The target weight will be shown in the weighing-in aid of the balance (SmartTrac). When a target weight including tolerances is defined, the SmartTrac indicates if the current display weight is in tolerance or not.	Numeric
-Tolerance	Defines the lower tolerance limit. This setting is only available if a <b>Target weight</b> is defined.	Numeric
+Tolerance	Defines the upper tolerance limit. This setting is only available if a <b>Target weight</b> is defined.	Numeric



### 6.2.4.6 Automation

Parameter	Description	Values
Barcode data target	<p>If a barcode reader is connected to the balance, this option defines how the data is to be processed.</p> <p><b>Keyboard Input:</b> The data is written in the currently open input window. If no input window is open, the data is ignored.</p> <p><b>Target weight value:</b> The barcode data is interpreted as a value for the target weight.</p> <p><b>Task ID 1:</b> The received barcode data is treated as identification text for this task ID.</p> <p><b>Result ID 1:</b> The received barcode data is treated as identification text for this result ID.</p> <p>The available items in the drop-down menu depend on the <b>Number of task IDs</b> and <b>Number of result IDs</b> specified for the method.</p> <p>Make sure that the characters of the scanned barcode are compatible with the format of the field where they should be inserted.</p>	Keyboard Input*   Target weight value   Task ID 1   Result ID 1   ...

\* Factory setting

#### Weighing automation

Parameter	Description	Values
Automatic zero	<p><b>Active:</b> the balance is automatically zeroed when the weight falls below a predefined threshold.</p> <p>This setting is not available for approved balances.</p>	Active   Inactive*
Automatic zero threshold	Defines the threshold of the <b>Automatic zero</b> . This setting is only available if <b>Automatic zero</b> is set to <b>Active</b> .	Numeric

Tare Mode	<p>Defines the tare mode.</p> <p><b>None:</b> No automatic tare.</p> <p><b>Automatic tare:</b> The balance stores automatically the first stable weight as the tare weight.</p> <p><b>Preset tare:</b> Allows you to enter manually a numerical entry of a fixed tare weight.</p>	None*   Automatic tare   Preset tare
Automatic tare threshold	<p>Defines the threshold of the option <b>Tare Mode</b>.</p> <p>This value defines the minimum weight that must be applied to the weighing pan so that it is automatically stored as the tare weight. If the weight is below the limits, it is not automatically transferred to the tare memory.</p> <p>Instead of entering the weight, the lightest tare container can be placed on the weighing pan and the button  subsequently pressed. The applied weight is directly taken over as a limit.</p> <p>This setting is only available if <b>Tare Mode</b> is set to <b>Automatic tare</b>.</p>	Numeric
Preset tare value	<p>Defines a weight value for the pretare function.</p> <p>Instead of entering the value, the respective tare container can be placed on the weighing pan and the button  subsequently pressed. The weight is directly taken over as pretare value.</p> <p>This setting is only available if <b>Tare Mode</b> is set to <b>Preset tare</b>.</p>	Numeric
Automatic result	<p>Automatically generates a weighing result after a threshold is reached.</p> <p><b>None:</b> No automatic result will be generated.</p> <p><b>Without sample tare:</b> After a weight value that reached the threshold is being removed from the weighing pan, the balance is not being tared.</p>	None*   Without sample tare
Automatic result threshold	<p>Defines the threshold of the <b>Automatic result</b>.</p> <p>The result is automatically added to the <b>Results list</b> only if the weight of the sample is larger than the defined threshold.</p> <p>This setting is only available if <b>Automatic result</b> is set to <b>Active</b>.</p>	Numeric
Weight trigger	<p>Defines the behaviour of the <b>Automatic result threshold</b>.</p> <p><b>Exceeding:</b> The weighing result is generated when the weight exceeds the defined threshold.</p> <p><b>Falling below:</b> The weighing result is generated when the weight falls below the defined threshold.</p> <p>This setting is only available if <b>Automatic result</b> is set to <b>Without sample tare</b>.</p>	Exceeding*   Falling below
Automatic tare after result	<p>If set to <b>Active</b>, the balance is automatically tared when a result is added to the <b>Results list</b>.</p>	Active   Inactive*

\* Factory setting

### See also

 [Creating a method "Titration" ▶ Page 44](#)

## 6.2.4.7 Print / Export

Parameter	Description	Values
Strip printout and data export	Defines the content of the printout and/or export, as well as which printing/exporting actions are performed automatically when the task is complete. This section contains several settings that are described in the table <b>Strip printout and data export</b> below.	
Label printout for task	Defines the template of the task label to be printed, i.e., which data is included on the label and in which format. This section contains several settings that are described in the table <b>Label printout for task</b> below.	
Label printout for weighing item	Defines the template of the weighing item label to be printed, i.e., which data is included on the label and in which format. This section contains several settings that are described in the table <b>Label printout for weighing item</b> below.	
Label cutting	Defines if the labels should be cut after printing. <b>Per label:</b> Each label is cut once printed. <b>Per task:</b> The labels are cut when the task is complete. This setting is only relevant if the connected label printer can cut labels.	Off*   Per label   Per task

\* Factory setting

### 6.2.4.7.1 Strip printout and data export

#### Automatic data output

Parameter	Description	Values
Strip printer	Activates/Deactivates automatic printing of the <b>Results list</b> on a strip printer when the <b>Complete</b> button is tapped. The data to be transmitted to the printer can be defined in the section <b>Template settings</b> .	Active   Inactive*
Results export	Activates/Deactivates the automatic data export to a file server or USB storage device when the <b>Complete</b> button is tapped.	Active   Inactive*
Weight value	Activates/Deactivates the option to automatically send the weighing value over USB or Ethernet when tapping <b>Add result</b> .	Active   Inactive*

\* Factory setting

#### Strip printout template

This menu item can be used to define which information is printed by the strip printer.

Each individual parameter can be set to **Inactive** or **Active** via the corresponding check box. To enable or disable all parameters at once, proceed as follows:

- To disable all check boxes at once, tap  **Deselect all**.
  - ➔ All parameters are set to **Inactive**.
- To enable all check boxes at once, tap  **Select all**.
  - ➔ All parameters are set to **Active**.

## Template settings

Parameter	Description	Values
Header and Footer	Defines the header and/or footer to be printed.	Title   Title text   Date/time   User   Signature   Separating lines   Group titles
Balance information	Defines which information about the balance is printed.	Balance type   Balance ID   Balance serial number   Software version
Quality information	Defines which quality information is printed.	Tolerance profile   Adjustment date/time   Routine test name   Routine test last execution date   Routine test result   GWP Approved state   Level state   MinWeigh state
Task information	Defines which information about the task is printed.	Method name   Method comment   Task IDs   Automatic result settings
Weighing item information	Defines which information about the weighing items is printed.	Show excluded weighing items   Result state   Result IDs   Density   Correction factor   GWP Approved state   Level state   MinWeigh state   Tolerance state   Target and tolerances
Result detail information	Defines which information related to the result of the measurement is printed.	Weight   Tare weight   Gross weight   Info weight   Date/time   Stability

### 6.2.4.7.2 Label printout for task

Parameter	Description	Values
Automatic label printout for task	When set to <b>Active</b> , the task label is automatically printed when tapping <b>Complete</b> .	Active   Inactive*
Copies	Defines how many copies of the label are printed.	Numeric
Used template	Chooses the label template.	Available labels are shown below.

\* Factory setting

### Field settings

The content of each label field can be defined individually.

Parameter	Description	Values
Label field 1	Defines which information appears in each label field. The number of label fields depends on the selected template.	Available entries depend on the method settings.

## Barcode settings

The content of each barcode field can be defined individually. This section is only available when the selected **Used template** contains at least one 2D code.

Parameter	Description	Values
Delimiter	Defines the delimiter between the barcode entries. This setting is only available when the selected <b>Used template</b> contains several 2D codes.	TAB*   Form feed   Carriage return   Space   User defined
Barcode field 1	Defines which information appears in each barcode. The number of the barcode fields depends on the selected template.	Available entries depend on the method settings.

\* Factory setting

### 6.2.4.7.3 Label printout for weighing item

Parameter	Description	Values
Automatic label printout for weighing item	When set to <b>Active</b> , the weighing item label is automatically printed when tapping <b>Add result</b> .	Active   Inactive*
Copies	Defines how many copies of the label are printed.	Numeric
Used template	Chooses the label template.	Available labels are shown below.

\* Factory setting

## Field settings

The content of each label field can be defined individually.

Parameter	Description	Values
Label field 1	Defines which information appears in each label field. The number of label fields depends on the selected template.	Available entries depend on the method settings.

## Barcode settings

The content of each barcode field can be defined individually. This section is only available when the selected **Used template** contains at least one 2D code.





Parameter	Description	Values
Delimiter	Defines the delimiter between the barcode entries. This setting is only available when the selected <b>Used template</b> contains several 2D codes.	TAB*   Form feed   Carriage return   Space   User defined
Barcode field 1	Defines which information appears in each barcode. The number of the barcode fields depends on the selected template.	Available entries depend on the method settings.

\* Factory setting

### 6.2.4.7.4 Available labels

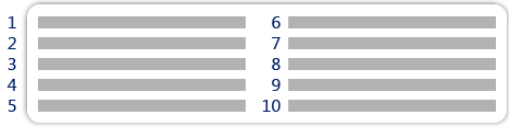
The following label layouts can be selected:

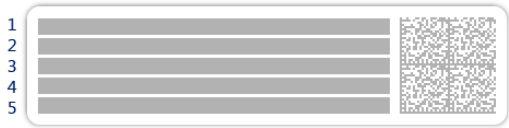
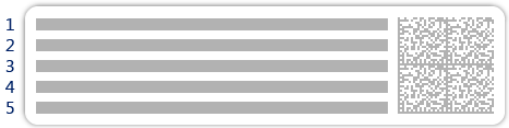
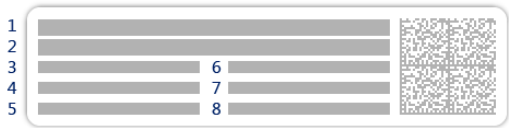
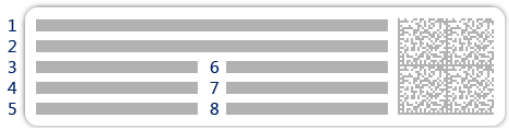

 <p>1D barcode with 10 small fields</p>	 <p>1D barcode with 3 large fields</p>
 <p>1D barcode with 3 small fields</p>	 <p>1D barcode with 6 small fields</p>
 <p>2D barcode with 5 large fields</p>	 <p>2D barcode with 5 small fields</p>
 <p>2D barcode with 2 large fields and 6 small fields</p>	 <p>2D barcode with 8 small fields</p>

## 6.2.5 Settings: method "Density determination"

Navigation: ▼ Methods > ≡ Methods list > 📄 my density > ✎ Edit

✎ Edit method - my density

General	Method type	Density determination
Density	Method name	my density
ID format	Comment	<i>Enter here</i>
Weighing		
Weighing item	Lock method	<input type="checkbox"/>
Automation		
Print / Export		

← Close
✓ Save

The settings of the method **Density determination** are grouped as follows:

- ≡ General
- 📄 Density
- 🆔 ID format
- ⚖ Weighing
- 🧪 Weighing item
- ⚙ Automation
- 🖨 Print / Export

### See also

- 🔗 [Creating a method "Density determination" ▶ Page 46](#)
- 🔗 [Editing a method ▶ Page 63](#)

### 6.2.5.1 General

The **Method type** is defined in the wizard while creating the method and cannot be changed.

Parameter	Description	Values
Method name	Defines the name of the method.	Text (1...22 characters)
Comment	The method can be described with a comment.	Text (0...128 characters)
Lock method	Locks the method to prevent further editing.	Active   Inactive*

\* Factory setting

### 6.2.5.2 Density

The **Determination type** is defined in the wizard while creating the method and cannot be changed. If another **Determination type** is required, a new method must be created. All settings for all types of **Density determination** are described here.

Parameter	Description	Values
Determination type	Defines the type of density determination measurement. <b>Liquid (pycnometer)</b> : Determines the density of a liquid in a glass vessel, such as a pycnometer. <b>Liquid (sinker)</b> : Determines the density of a liquid. <b>Solid</b> : Determines the density of a solid with the help of a density kit.	Liquid (pycnometer)   Liquid (sinker)   Solid*



Density unit	Defines the unit to be used for density determination. <b>g/cm<sup>3</sup></b> = grams per cm <sup>3</sup> <b>kg/m<sup>3</sup></b> = kilograms per m <sup>3</sup> <b>g/l</b> = grams per liter	g/cm <sup>3</sup> *   kg/m <sup>3</sup>   g/l
Density value decimal places	Defines the number of decimal places with which the density is displayed and saved.	1   2   3*   4   5
Air density compensation	Defines the correction factor for force calibration. <b>Active</b> : the density determination result is corrected by the force calibration correction factor and mean air density. <b>Inactive</b> : no correction is applied.	Active*   Inactive

\* Factory setting

### See also

[Creating a method "Density determination"](#) ▶ Page 46

## 6.2.5.3 ID format

### Task IDs

Parameter	Description	Values
Number of task IDs	Defines the number of task IDs. If the <b>Number of task IDs</b> is larger than 0, the settings <b>Task ID</b> , <b>Task description</b> and <b>Prefix/Default value</b> are available for every single task ID.	0   1*   2   3
Task ID 1	Defines the naming type of the task ID. <b>Manual with default</b> : The value of the task ID can be entered manually at method execution time. <b>Automatic timestamp</b> : The system provides a value created from a prefix with the current date and time appended.	Manual with default*   Automatic timestamp
Task description	Allows to define a label for each task ID field.	Text (0...32 characters)
Default value	Defines a default value for the task ID. The value of the task ID can be changed manually while executing the method. This setting is only available when the corresponding <b>Task ID</b> is set to <b>Manual with default</b> .	Text (0...32 characters)
Prefix	Defines a prefix for the task ID. This setting is only available is the corresponding <b>Task ID</b> is set to <b>Automatic timestamp</b> .	Text (0...32 characters)

\* Factory setting

### Result IDs

Parameter	Description	Values
Number of result IDs	Defines the number of result IDs. If the <b>Number of result IDs</b> is larger than 0, the settings <b>Result ID</b> , <b>Result description</b> and <b>Prefix/Default value</b> are available for every single result ID.	0   1*   2   3
Result ID 1	Defines the naming type of the result ID. <b>Manual with default</b> : The value of the result ID can be entered manually at method execution time. <b>Automatic counter</b> : The system provides a value created from a <b>Prefix</b> to which is appended a unique number (counter).	Manual with default*   Automatic counter
Result description	Allows to define a label for each result ID.	Text (0...32 characters)

Default value	Defines a default value for the result ID. The value of the result ID can be changed manually while executing the method. This setting is only available when the corresponding <b>Result ID</b> is set to <b>Manual with default</b> .	Text (0...32 characters)
Prefix	Defines a prefix for the result ID. This setting is only available if the corresponding <b>Result ID</b> is set to <b>Automatic counter</b> .	Text (0...32 characters)

\* Factory setting

#### 6.2.5.4 Weighing

Parameter	Description	Values
Show info weight	When set to <b>Active</b> , a secondary weight is displayed on the weighing screen.	Active   Inactive*
Info unit	Defines the unit of the <b>Info weight</b> . This setting is only available if <b>Show info weight</b> is set to <b>Active</b> .	The available units depend on the balance model.

\* Factory setting

#### Weighing settings

Parameter	Description	Values
Tolerance profile	A tolerance profile stores all the necessary balance settings needed for a certain weighing method. It is possible to create different tolerance profiles for different weighing methods.	Tolerance profiles are created by the user for specific balances and applications.
Weight capture mode	Defines the behavior when the button to add the result was tapped or the add result was triggered by the automatic weighing result creation. <b>Stable</b> : The system waits for a stable weight. <b>Immediate</b> : The system doesn't wait for a stable weight. The system waits for the defined amount of seconds ( <b>Weight capture delay</b> ). After the weight capture delay, the weight value from the weight stream is captured.	Stable*   Immediate
Weight capture delay	Defines the time in seconds the balance waits for capturing the weight after the button to add the result was tapped or the add result was triggered by the automatic weighing result creation. This setting is only available if <b>Weight capture mode</b> is set to <b>Immediate</b> .	Numeric (5 seconds*   0...60 seconds)

\* Factory setting

## Statistics

Parameter	Description	Values
Activate statistics	<p>If <b>Activate statistics</b> is set to <b>Active</b>, the following statistics will be calculated:</p> <p><b>Count:</b> Number of items used for the statistics</p> <p><b>Sum:</b> sum of all value (decimal places and unit according to the method settings)</p> <p><b>Minimum:</b> smallest value (decimal places and unit according to the method settings)</p> <p><b>Maximum:</b> largest value (decimal places and unit according to the method setting)</p> <p><b>Range:</b> difference between the largest and smallest values (decimal places and unit according to the method settings)</p> <p><b>Average:</b> The values are summed up and divided by the number of values, rounded to 1 digit more than the configured decimal places in the associated tolerance profile (unit according to the method settings).</p> <p><b>Standard deviation:</b> standard deviation rounded to 1 digit more than the configured decimal places in the associated tolerance profile (unit according to the method settings)</p> <p><b>Relative standard deviation:</b> relative standard deviation (rounded to 2 decimal places, in %)</p> <p>The statistical values are calculated and displayed as soon as a result is added or updated.</p>	Active   Inactive*

\* Factory setting

### See also

[Creating a method "Density determination" ▶ Page 46](#)

### 6.2.5.5 Weighing item

The **Weighing item** settings are different for the three types of **Density determination**. The settings for **Initial values for weighing** are presented separately for each **Determination type**.

#### Initial values for weighing – Determination type: Solid

Parameter	Description	Values
Unit	Defines the unit of the weighing result.	The available units depend on the balance model.
Temperature	Defines the temperature of the auxiliary liquid (distilled water or custom).	Numeric (10°C...30.9°C)
Aux. liquid	Defines the type of auxiliary liquid used for the determination of the density of a solid.	Distilled water*   Custom
Aux. liquid name	Defines the name of the custom auxiliary liquid. This setting is only available if <b>Aux. liquid</b> is set to <b>Custom</b> .	Text (0...32 characters)
Aux. liquid density	Defines the density of the custom auxiliary liquid. This setting is only available if <b>Aux. liquid</b> is set to <b>Custom</b> .	Numeric (0.00001... 100 g/cm <sup>3</sup> )

\* Factory setting

### Initial values for weighing – Determination type: Liquid (sinker)

Parameter	Description	Values
Unit	Defines the unit of the weighing result.	The available units depend on the balance model.
Temperature	Defines the temperature of the liquid.	Numeric (10°C...30.9°C)
Sinker volume	Defines the volume of the sinker in cm <sup>3</sup> .	Numeric (0.0001 ...500 cm <sup>3</sup> )

### Initial values for weighing – Determination type: Liquid (pycnometer)

Parameter	Description	Values
Unit	Defines the unit of the weighing result.	The available units depend on the balance model.
Temperature	Defines the temperature of the liquid.	Numeric (10°C...30.9°C)
Pycnometer volume	Defines volume of the pycnometer in cm <sup>3</sup> .	Numeric (0.001 ...10000 cm <sup>3</sup> )
Pycnometer weight	Defines the weight of the pycnometer.	Numeric

#### See also

 [Creating a method "Density determination" ▶ Page 46](#)

### 6.2.5.6 Automation

Parameter	Description	Values
Barcode data target	<p>If a barcode reader is connected to the balance, this option defines how the data is to be processed.</p> <p><b>Keyboard Input:</b> The data is written in the currently open input window. If no input window is open, the data is ignored.</p> <p><b>Task ID 1:</b> The received barcode data is treated as identification text for this task ID.</p> <p><b>Result ID 1:</b> The received barcode data is treated as identification text for this result ID.</p> <p>The available items in the drop-down menu depend on the <b>Number of task IDs</b> and <b>Number of result IDs</b> specified for the method.</p> <p>Make sure that the characters of the scanned barcode are compatible with the format of the field where they should be inserted.</p>	Keyboard Input*   Task ID 1   Result ID 1   ...

\* Factory setting

#### See also

 [Creating a method "Density determination" ▶ Page 46](#)

## 6.2.5.7 Print / Export

Parameter	Description	Values
Strip printout and data export	Defines the content of the printout and/or export, as well as which printing/exporting actions are performed automatically when the task is complete.  This section contains several settings that are described in the table <b>Strip printout and data export</b> below.	

### 6.2.5.7.1 Strip printout and data export

#### Automatic data output

Parameter	Description	Values
Strip printer	Activates/Deactivates automatic printing of the <b>Results list</b> on a strip printer when the <b>Complete</b> button is tapped. The data to be transmitted to the printer can be defined in the section <b>Template settings</b> .	Active   Inactive*
Results export	Activates/Deactivates the automatic data export to a file server or USB storage device when the <b>Complete</b> button is tapped.	Active   Inactive*

\* Factory setting

#### Strip printout template

This menu item can be used to define which information is printed by the strip printer.

Each individual parameter can be set to **Inactive** or **Active** via the corresponding check box. To enable or disable all parameters at once, proceed as follows:

- To disable all check boxes at once, tap  **Deselect all**.
  - ➔ All parameters are set to **Inactive**.
- To enable all check boxes at once, tap  **Select all**.
  - ➔ All parameters are set to **Active**.

#### Template settings

Parameter	Description	Values
Header and Footer	Defines the header and/or footer to be printed.	Title   Title text   Date/time   User   Signature   Separating lines   Group titles
Balance information	Defines which information about the balance is printed.	Balance type   Balance ID   Balance serial number   Software version
Quality information	Defines which quality information is printed.	Tolerance profile   Adjustment date/time   Routine test name   Routine test last execution date   Routine test result   GWP Approved state   Level state   MinWeigh state

Task information	Defines which information about the task is printed.	Method name   Method comment   Task IDs   Count   Average   Minimum   Maximum   Standard deviation   Relative standard deviation   Type of density determination   Decimal places for density weighing results   Air density compensation
Weighing item information	Defines which information about the weighing items is printed.	Show excluded weighing items   Result state   Result IDs   GWP Approved state   Level state   MinWeigh state   Temperature   Auxiliary liquid name and density   Volume of sample   Weight of sample in air   Weight of sample in liquid
Result detail information	Defines which information related to the result of the measurement is printed.	Weight   Tare weight   Gross weight   Info weight   Date/time   Stability

## 6.2.6 Settings: method "SQC"

Navigation: ▼ Methods > Methods list > my SQC > Edit

The settings of the method **SQC** are grouped as follows:

- **General**
- **ID format**
- **Weighing**
- **Weighing item**
- **Automation**
- **Print / Export**

### See also

[Creating a method "SQC" ▶ Page 47](#)

[Editing a method ▶ Page 63](#)

### 6.2.6.1 General

The **Method type** is defined in the wizard while creating the method and cannot be changed.

Parameter	Description	Values
Method name	Defines the name of the method.	Text (1...22 characters)
Comment	The method can be described with a comment.	Text (0...128 characters)
Lock method	Locks the method to prevent further editing.	Active   Inactive*

\* Factory setting

### 6.2.6.2 ID format

#### Task IDs

Parameter	Description	Values
Number of task IDs	Defines the number of task IDs. If the <b>Number of task IDs</b> is larger than 0, the settings <b>Task ID</b> , <b>Task description</b> and <b>Prefix/Default value</b> are available for every single task ID.	0   1*   2   3
Task ID 1	Defines the naming type of the task ID. <b>Manual with default:</b> The value of the task ID can be entered manually at method execution time. <b>Automatic timestamp:</b> The system provides a value created from a prefix with the current date and time appended.	Manual with default*   Automatic timestamp

Task description	Allows to define a label for each task ID field.	Text (0...32 characters)
Default value	Defines a default value for the task ID. The value of the task ID can be changed manually while executing the method. This setting is only available when the corresponding <b>Task ID</b> is set to <b>Manual with default</b> .	Text (0...32 characters)
Prefix	Defines a prefix for the task ID. This setting is only available is the corresponding <b>Task ID</b> is set to <b>Automatic timestamp</b> .	Text (0...32 characters)

\* Factory setting

### Result IDs

Parameter	Description	Values
Number of result IDs	Defines the number of result IDs. If the <b>Number of result IDs</b> is larger than 0, the settings <b>Result ID</b> , <b>Result description</b> and <b>Prefix/Default value</b> are available for every single result ID.	0*   1   2   3
Result ID 1	Defines the naming type of the result ID. <b>Manual with default:</b> The value of the result ID can be entered manually at method execution time. <b>Automatic counter:</b> The system provides a value created from a <b>Prefix</b> to which is appended a unique number (counter).	Manual with default*   Automatic counter
Result description	Allows to define a label for each result ID.	Text (0...32 characters)
Default value	Defines a default value for the result ID. The value of the result ID can be changed manually while executing the method. This setting is only available when the corresponding <b>Result ID</b> is set to <b>Manual with default</b> .	Text (0...32 characters)
Prefix	Defines a prefix for the result ID. This setting is only available if the corresponding <b>Result ID</b> is set to <b>Automatic counter</b> .	Text (0...32 characters)

\* Factory setting

## 6.2.6.3 Weighing

### Weighing settings

Parameter	Description	Values
Tolerance profile	A tolerance profile stores all the necessary balance settings needed for a certain weighing method. It is possible to create different tolerance profiles for different weighing methods.	Tolerance profiles are created by the user for specific balances and applications.



## Statistics

Parameter	Description	Values
Custom time span statistics 1	<p>Allows the user to define a custom time span for the calculation of statistics. If activated, the weighing information of each new item is added to the batch statistics until the statistics are <b>Reset</b> manually by the user.</p> <p>If <b>Custom time span statistics 1</b> is set to <b>Active</b>, the following statistics will be calculated:</p> <p><b>Count</b>: number of items used for the statistics</p> <p><b>Sum</b>: sum of all value (decimal places and unit according to the method settings)</p> <p><b>Minimum</b>: smallest value (decimal places and unit according to the method settings)</p> <p><b>Maximum</b>: largest value (decimal places and unit according to the method setting)</p> <p><b>Range</b>: difference between the largest and smallest values (decimal places and unit according to the method settings)</p> <p><b>Average</b>: The values are summed up and divided by the number of values, rounded to 1 digit more than the configured decimal places in the associated tolerance profile (unit according to the method settings).</p> <p><b>Standard deviation</b>: standard deviation rounded to 1 digit more than the configured decimal places in the associated tolerance profile (unit according to the method settings)</p> <p><b>Relative standard deviation</b>: relative standard deviation (rounded to 2 decimal places, in %)</p> <p>The statistical values are calculated and displayed as soon as a result is added or updated.</p>	Active   Inactive*
Statistics 1 - Name	<p>Defines the name of the custom time span statistics.</p> <p>This setting is only available if <b>Custom time span statistics 1</b> is set to <b>Active</b>.</p>	Text (1...22 characters)
Custom time span statistics 2	<p>Allows the user to define a second custom time span for the calculation of the statistics. Refer to the description of <b>Custom time span statistics 1</b> for more details.</p>	Active   Inactive*
Statistics 2 - Name	<p>Defines the name of the custom time span statistics.</p> <p>This setting is only available if <b>Custom time span statistics 2</b> is set to <b>Active</b>.</p>	Text (1...22 characters)

\* Factory setting

## Electrostatic

Parameter	Description	Values
Ionizer	Defines whether the ionizer is activated/deactivated.	Active   Inactive*
Detection	Activates or deactivates electrostatic detection (StaticDetect).	Active   Inactive*
Threshold	<p>Defines the maximum acceptable weighing error due to electrostatic charges.</p> <p>If the measured approximate weighing error is smaller or equal to the detection threshold, the StaticDetect state is <b>OK</b>.</p> <p>If the measured approximate weighing error is larger than the detection threshold, the StaticDetect state is <b>Not OK</b>.</p> <p>This setting is only available if <b>Detection</b> is set to <b>Active</b>.</p>	Numeric

Show weighing error	Displays the weighing error or not. <b>Active:</b> If the StaticDetect value is above the threshold, the effective approximate weighing error is displayed. This setting is only available if <b>Detection</b> is <b>Active</b> .	Active*   Inactive
---------------------	---	--------------------

\* Factory setting

### See also

[Creating a method "SQC" ▶ Page 47](#)

## 6.2.6.4 Weighing item

Parameter	Description	Values
Liquid	If the weighing item is a liquid, the <b>Nominal</b> value is specified as a volume instead of a weight. If <b>Liquid</b> is set to <b>Active</b> , the <b>Liquid density</b> must be provided.	Active   Inactive*
Unit	Defines the unit of the <b>Nominal</b> weight or volume.	The available units depend on other method settings.
Liquid density	Defines the density of the liquid. This density is used to convert the weighing result to a volume. This setting is only available if <b>Liquid</b> is set to <b>Active</b> .	Numeric
Calculate net weight excl. packaging	Defines if the net weight excluding the packaging should be calculated for each item. If set to <b>Active</b> , a defined <b>Packaging</b> is subtracted from each weighing.	Active   Inactive*
Packaging	Defines the reference weight of the packaging. Instead of entering the reference weight manually, place the empty packaging on the weighing pan and tap the button  . The applied weight is directly taken over as a reference weight. This setting is only available if <b>Calculate net weight excl. packaging</b> is set to <b>Active</b> .	Depending on the capacity of the balance.
Use measured average as nominal	Allows the nominal value to be calculated from the average of all items.	Active   Inactive*
Plausibility reference	Defines a reference nominal value for plausibility check, only if the nominal value is calculated from the average of all items. This setting is only available if <b>Use measured average as nominal</b> is set to <b>Active</b> .	Numeric
Nominal weight	Defines the value for the nominal weight. The nominal weight is defined as the expected weight of the measured object.	Numeric
Plausibility limits	Defines the plausibility limit for measured values. The plausibility limit relates to the defined target weight. Example: With a plausibility limit of 30%, all weight values that are within $\pm 30\%$ of the target weight are regarded as plausible and are transferred into the statistics. All other weight values are being ignored and excluded from the statistics.	Numeric (30%*   0...100%)
-Tolerance T1	Defines the lower tolerance limit.	Numeric
+Tolerance T1	Defines the upper tolerance limit.	Numeric

T2 tolerances	<p>Defines if a second set of tolerances is used.</p> <p>The T2 tolerances must be bigger than the T1 tolerances.</p> <p>If set to <b>Active</b>, the statistics will report the number of counts as follows:</p> <ul style="list-style-type: none"> <li>• <b>Count above +T2</b></li> <li>• <b>Count between +T1 and +T2</b></li> <li>• <b>Count between -T1 and +T1</b></li> <li>• <b>Count between -T2 and -T1</b></li> <li>• <b>Count below -T2</b></li> </ul>	Active   Inactive*
-Tolerance T2	<p>Defines the lower tolerance limit.</p> <p>This setting is only available if <b>T2 tolerances</b> is set to <b>Active</b></p>	Numeric
+Tolerance T2	<p>Defines the upper tolerance limit.</p> <p>This setting is only available if <b>T2 tolerances</b> is set to <b>Active</b></p>	Numeric

\* Factory setting

### See also

 [Creating a method "SQC" ▶ Page 47](#)

## 6.2.6.5 Automation

Parameter	Description	Values
Barcode data target	<p>If a barcode reader is connected to the balance, this option defines how the data is to be processed.</p> <p><b>Keyboard Input:</b> The data is written in the currently open input window. If no input window is open, the data is ignored.</p> <p><b>Task ID 1:</b> The received barcode data is treated as identification text for this task ID.</p> <p>The available items in the drop-down menu depend on the <b>Number of task IDs</b> specified for the method.</p> <p>Make sure that the characters of the scanned barcode are compatible with the format of the field where they should be inserted.</p>	Keyboard Input*   Task ID 1   ...
Number of weighing items	Defines the number of items used for the weighing task.	Numeric

\* Factory setting

### Automatic feeder support



When the parameter **Automatic feeder support** is activated, additional parameters can be defined to set up the automatic feeder LV12.

Parameter	Description	Values
Automatic feeder support	<p>Enables or disables the automatic feeder support.</p> <p>To use the automatic feeder support, the automatic feeder has to be connected to the balance by USB and has to be configured correctly.</p>	Active   Inactive*
Discharge feeder at the end	<p>Specifies if the automatic feeder is emptied of all objects after the task.</p> <p><b>Active:</b> The automatic feeder feeds at the configured discharge feed rate and stops 90 seconds after the last object has passed the light barrier.</p> <p><b>Inactive:</b> No automatic emptying.</p>	Active   Inactive*

Feed rate	Defines the rate at which the automatic feeder delivers the items to the balance.	Slow   Normal*   Fast   Very fast
-----------	---	-----------------------------------

\* Factory setting

### Weighing automation

Parameter	Description	Values
Automatic zero	<b>Active:</b> the balance is automatically zeroed when the weight falls below a predefined threshold. This setting is not available for approved balances.	Active   Inactive*
Automatic zero threshold	Defines the threshold of the <b>Automatic zero</b> . This setting is only available if <b>Automatic zero</b> is set to <b>Active</b> .	Numeric
Tare Mode	Defines the tare mode. <b>None:</b> No automatic tare. <b>Automatic tare:</b> The balance stores automatically the first stable weight as the tare weight. <b>Preset tare:</b> Allows you to enter manually a numerical entry of a fixed tare weight.	None*   Automatic tare   Preset tare
Automatic tare threshold	Defines the threshold of the option <b>Tare Mode</b> . This value defines the minimum weight that must be applied to the weighing pan so that it is automatically stored as the tare weight. If the weight is below the limits, it is not automatically transferred to the tare memory. Instead of entering the weight, the lightest tare container can be placed on the weighing pan and the button  subsequently pressed. The applied weight is directly taken over as a limit. This setting is only available if <b>Tare Mode</b> is set to <b>Automatic tare</b> .	Numeric
Preset tare value	Defines a weight value for the pretare function. Instead of entering the value, the respective tare container can be placed on the weighing pan and the button  subsequently pressed. The weight is directly taken over as pretare value. This setting is only available if <b>Tare Mode</b> is set to <b>Preset tare</b> .	Numeric
Automatic result	Automatically generates a weighing result after a threshold is reached. <b>None:</b> No automatic result will be generated. <b>Without sample tare:</b> After a weight value that reached the threshold is being removed from the weighing pan, the balance is not being tared. If <b>Automatic feeder support</b> is activated, the setting <b>Automatic result</b> is automatically set to <b>Without sample tare</b> and cannot be edited.	None*   Without sample tare
Automatic result threshold	Defines the threshold of the <b>Automatic result</b> . The result is automatically added to the <b>Results list</b> only if the weight of the sample is larger than the defined threshold. This setting is only available if <b>Automatic result</b> is set to <b>Active</b> .	Numeric

Weight trigger	<p>Defines the behaviour of the option <b>Automatic result threshold</b>.</p> <p><b>Exceeding:</b> The weighing result is generated when the weight exceeds the defined threshold.</p> <p><b>Falling below:</b> The weighing result is generated when the weight falls below the defined threshold.</p> <p>This setting is only available if <b>Automatic result</b> is set to <b>Without sample tare</b>.</p> <p>If <b>Automatic feeder support</b> is activated, the setting <b>Weight trigger</b> is automatically set to <b>Exceeding</b> and cannot be edited.</p>	Exceeding*   Falling below
Automatic tare after result	If set to <b>Active</b> , the balance is automatically tared when a result is added to the <b>Results list</b> .	Active   Inactive*

\* Factory setting

### See also

 [Creating a method "SQC" ▶ Page 47](#)

## 6.2.6.6 Print / Export

Parameter	Description	Values
Strip printout and data export	<p>Defines the content of the printout and/or export, as well as which printing/exporting actions are performed automatically when the task is complete.</p> <p>This section contains several settings that are described in the table <b>Strip printout and data export</b> below.</p>	

### 6.2.6.6.1 Strip printout and data export

#### Automatic data output



Parameter	Description	Values
Strip printer	Activates/Deactivates automatic printing of the <b>Results list</b> on a strip printer when the <b>Complete</b> button is tapped. The data to be transmitted to the printer can be defined in the section <b>Template settings</b> .	Active   Inactive*
Results export	Activates/Deactivates the automatic data export to a file server or USB storage device when the <b>Complete</b> button is tapped.	Active   Inactive*
Weight value	Activates/Deactivates the option to automatically send the weighing value over USB or Ethernet when tapping <b>Add result</b> .	Active   Inactive*

\* Factory setting

#### Strip printout template

This menu item can be used to define which information is printed by the strip printer.

Each individual parameter can be set to **Inactive** or **Active** via the corresponding check box. To enable or disable all parameters at once, proceed as follows:

- To disable all check boxes at once, tap  **Deselect all**.
  - ➔ All parameters are set to **Inactive**.
- To enable all check boxes at once, tap  **Select all**.
  - ➔ All parameters are set to **Active**.

## Template settings

Parameter	Description	Values
Header and Footer	Defines the header and/or footer to be printed.	Title   Title text   Date/time   User   Signature   Separating lines   Group titles
Balance information	Defines which information about the balance is printed.	Balance type   Balance ID   Balance serial number   Software version
Quality information	Defines which quality information is printed.	Tolerance profile   Adjustment date/time   Routine test name   Routine test last execution date   Routine test result   GWP Approved state   Level state   MinWeigh state
Task information	Defines which information about the task is printed.	Method name   Method comment   Task IDs   Start and end date/time   Automatic result settings   In tolerance chart   Count   Average   Minimum   Maximum   Range   Standard deviation   Relative standard deviation   Count above +T2   Count between +T1 and +T2   Count between -T1 and +T1   Count between -T2 and -T1   Count below -T2
Weighing item information	Defines which information about the weighing items is printed/exported.	Show excluded weighing items   Result state   Result IDs   Liquid density   Calculate net weight excl. packaging   Packaging   Use measured average as nominal   GWP Approved state   Electrostatic charge   Level state   MinWeigh state   Tolerance state   Nominal and tolerances   Plausibility reference and tolerances   Plausibility limits
Result detail information	Defines which information related to the result of the measurement is printed.	Weight   Tare weight   Gross weight   Info weight   Date/time   Stability

## 6.2.7 Settings: method "Piece Counting"

Navigation: ▼ Methods > ☰ Methods list > 🏠 my piece counting > ✎ Edit

The settings of the method **Piece Counting** are grouped as follows:

- ☰ **General**
- 🆔 **ID format**
- ⚖️ **Weighing**
- ⚙️ **Weighing item**
- ⚙️ **Automation**
- 🖨️ **Print / Export**

### See also

- 🔗 [Creating a method "Piece Counting" ▶ Page 52](#)
- 🔗 [Editing a method ▶ Page 63](#)

### 6.2.7.1 General

The **Method type** is defined in the wizard while creating the method and cannot be changed.

Parameter	Description	Values
Method name	Defines the name of the method.	Text (1...22 characters)
Comment	The method can be described with a comment.	Text (0...128 characters)
Lock method	Locks the method to prevent further editing.	Active   Inactive*

\* Factory setting

### 6.2.7.2 ID format

#### Task IDs

Parameter	Description	Values
Number of task IDs	Defines the number of task IDs. If the <b>Number of task IDs</b> is larger than 0, the settings <b>Task ID</b> , <b>Task description</b> and <b>Prefix/Default value</b> are available for every single task ID.	0   1*   2   3
Task ID 1	Defines the naming type of the task ID. <b>Manual with default:</b> The value of the task ID can be entered manually at method execution time. <b>Automatic timestamp:</b> The system provides a value created from a prefix with the current date and time appended.	Manual with default*   Automatic timestamp

Task description	Allows to define a label for each task ID field.	Text (0...32 characters)
Default value	Defines a default value for the task ID. The value of the task ID can be changed manually while executing the method. This setting is only available when the corresponding <b>Task ID</b> is set to <b>Manual with default</b> .	Text (0...32 characters)
Prefix	Defines a prefix for the task ID. This setting is only available is the corresponding <b>Task ID</b> is set to <b>Automatic timestamp</b> .	Text (0...32 characters)

\* Factory setting

### Result IDs

Parameter	Description	Values
Number of result IDs	Defines the number of result IDs. If the <b>Number of result IDs</b> is larger than 0, the settings <b>Result ID</b> , <b>Result description</b> and <b>Prefix/Default value</b> are available for every single result ID.	0   1*   2   3
Result ID 1	Defines the naming type of the result ID. <b>Manual with default:</b> The value of the result ID can be entered manually at method execution time. <b>Automatic counter:</b> The system provides a value created from a <b>Prefix</b> to which is appended a unique number (counter).	Manual with default*   Automatic counter
Result description	Allows to define a label for each result ID.	Text (0...32 characters)
Default value	Defines a default value for the result ID. The value of the result ID can be changed manually while executing the method. This setting is only available when the corresponding <b>Result ID</b> is set to <b>Manual with default</b> .	Text (0...32 characters)
Prefix	Defines a prefix for the result ID. This setting is only available if the corresponding <b>Result ID</b> is set to <b>Automatic counter</b> .	Text (0...32 characters)

\* Factory setting

### 6.2.7.3 Weighing

Parameter	Description	Values
Show info weight	When set to <b>Active</b> , a secondary weight is displayed on the weighing screen.	Active   Inactive*
Info unit	Defines the unit of the <b>Info weight</b> . This setting is only available if <b>Show info weight</b> is set to <b>Active</b> .	The available units depend on the balance model.

\* Factory setting

### Weighing settings

Parameter	Description	Values
Tolerance profile	A tolerance profile stores all the necessary balance settings needed for a certain weighing method. It is possible to create different tolerance profiles for different weighing methods.	Tolerance profiles are created by the user for specific balances and applications.



Weight capture mode	Defines the behavior when the button to add the result was tapped or the add result was triggered by the automatic weighing result creation. <b>Stable:</b> The system waits for a stable weight. <b>Immediate:</b> The system doesn't wait for a stable weight. The system waits for the defined amount of seconds ( <b>Weight capture delay</b> ). After the weight capture delay, the weight value from the weight stream is captured.	Stable*   Immediate
Weight capture delay	Defines the time in seconds the balance waits for capturing the weight after the button to add the result was tapped or the add result was triggered by the automatic weighing result creation. This setting is only available if <b>Weight capture mode</b> is set to <b>Immediate</b> .	Numeric (5 seconds*   0...60 seconds)

\* Factory setting

### Statistics

Parameter	Description	Values
Activate statistics	<p>If <b>Activate statistics</b> is set to <b>Active</b>, the following statistics will be calculated:</p> <p><b>Count:</b> Number of items used for the statistics</p> <p><b>Sum:</b> sum of all value (decimal places and unit according to the method settings)</p> <p><b>Minimum:</b> smallest value (decimal places and unit according to the method settings)</p> <p><b>Maximum:</b> largest value (decimal places and unit according to the method setting)</p> <p><b>Range:</b> difference between the largest and smallest values (decimal places and unit according to the method settings)</p> <p><b>Average:</b> The values are summed up and divided by the number of values, rounded to 1 digit more than the configured decimal places in the associated tolerance profile (unit according to the method settings).</p> <p><b>Standard deviation:</b> standard deviation rounded to 1 digit more than the configured decimal places in the associated tolerance profile (unit according to the method settings)</p> <p><b>Relative standard deviation:</b> relative standard deviation (rounded to 2 decimal places, in %)</p> <p>The statistical values are calculated and displayed as soon as a result is added or updated.</p>	Active   Inactive*

\* Factory setting

### See also

 [Creating a method "Piece Counting" ▶ Page 52](#)

## 6.2.7.4 Weighing item

### Initial values for weighing

Parameter	Description	Values
Reference PCS	Defines the number of items used to determine the average weight per item.	Numeric (1*   1... 10000)

Reference average weight	Defines the average weight for one piece. The average weight of one piece serves as basis for the piece counting. During task execution, the balance calculates the actual number of pieces on the weighing pan based on the measured weight and the average weight of one piece.	Numeric
Target weight	Defines the target weight. The target weight will be shown in the weighing-in aid of the balance (SmartTrac). When a target weight including tolerances is defined, the SmartTrac indicates if the current display weight is in tolerance or not.	Numeric
-Tolerance	Defines the lower tolerance limit. This setting is only available if a <b>Target weight</b> is defined.	Numeric
+Tolerance	Defines the upper tolerance limit. This setting is only available if a <b>Target weight</b> is defined.	Numeric

\* Factory setting

### See also

[Creating a method "Piece Counting" ▶ Page 52](#)



## 6.2.7.5 Automation

Parameter	Description	Values
Barcode data target	<p>If a barcode reader is connected to the balance, this option defines how the data is to be processed.</p> <p><b>Keyboard Input:</b> The data is written in the currently open input window. If no input window is open, the data is ignored.</p> <p><b>Target weight value:</b> The barcode data is interpreted as a value for the target weight.</p> <p><b>Task ID 1:</b> The received barcode data is treated as identification text for this task ID.</p> <p><b>Result ID 1:</b> The received barcode data is treated as identification text for this result ID.</p> <p>The available items in the drop-down menu depend on the <b>Number of task IDs</b> and <b>Number of result IDs</b> specified for the method.</p> <p>Make sure that the characters of the scanned barcode are compatible with the format of the field where they should be inserted.</p>	Keyboard Input*   Target weight value   Task ID 1   Result ID 1   ...

\* Factory setting

### Weighing automation

Parameter	Description	Values
Automatic zero	<p><b>Active:</b> the balance is automatically zeroed when the weight falls below a predefined threshold.</p> <p>This setting is not available for approved balances.</p>	Active   Inactive*
Automatic zero threshold	<p>Defines the threshold of the <b>Automatic zero</b>.</p> <p>This setting is only available if <b>Automatic zero</b> is set to <b>Active</b>.</p>	Numeric

Tare Mode	<p>Defines the tare mode.</p> <p><b>None:</b> No automatic tare.</p> <p><b>Automatic tare:</b> The balance stores automatically the first stable weight as the tare weight.</p> <p><b>Preset tare:</b> Allows you to enter manually a numerical entry of a fixed tare weight.</p>	None*   Automatic tare   Preset tare
Automatic tare threshold	<p>Defines the threshold of the option <b>Tare Mode</b>.</p> <p>This value defines the minimum weight that must be applied to the weighing pan so that it is automatically stored as the tare weight. If the weight is below the limits, it is not automatically transferred to the tare memory.</p> <p>Instead of entering the weight, the lightest tare container can be placed on the weighing pan and the button  subsequently pressed. The applied weight is directly taken over as a limit.</p> <p>This setting is only available if <b>Tare Mode</b> is set to <b>Automatic tare</b>.</p>	Numeric
Preset tare value	<p>Defines a weight value for the pretare function.</p> <p>Instead of entering the value, the respective tare container can be placed on the weighing pan and the button  subsequently pressed. The weight is directly taken over as pretare value.</p> <p>This setting is only available if <b>Tare Mode</b> is set to <b>Preset tare</b>.</p>	Numeric
Automatic result	<p>Automatically generates a weighing result after a threshold is reached.</p> <p><b>None:</b> No automatic result will be generated.</p> <p><b>Without sample tare:</b> After a weight value that reached the threshold is being removed from the weighing pan, the balance is not being tared.</p>	None*   Without sample tare
Automatic result threshold	<p>Defines the threshold of the <b>Automatic result</b>.</p> <p>The result is automatically added to the <b>Results list</b> only if the weight of the sample is larger than the defined threshold.</p> <p>This setting is only available if <b>Automatic result</b> is set to <b>Active</b>.</p>	Numeric
Weight trigger	<p>Defines the behaviour of the <b>Automatic result threshold</b>.</p> <p><b>Exceeding:</b> The weighing result is generated when the weight exceeds the defined threshold.</p> <p><b>Falling below:</b> The weighing result is generated when the weight falls below the defined threshold.</p> <p>This setting is only available if <b>Automatic result</b> is set to <b>Without sample tare</b>.</p>	Exceeding*   Falling below
Automatic tare after result	<p>If set to <b>Active</b>, the balance is automatically tared when a result is added to the <b>Results list</b>.</p>	Active   Inactive*

\* Factory setting

When using **Automatic result**, make sure that the **Reference average weight** of one piece is larger than the **Automatic result threshold**.

#### See also

 [Creating a method "Piece Counting" ▶ Page 52](#)

## 6.2.7.6 Print / Export

Parameter	Description	Values
Strip printout and data export	Defines the content of the printout and/or export, as well as which printing/exporting actions are performed automatically when the task is complete. This section contains several settings that are described in the table <b>Strip printout and data export</b> below.	
Label printout for task	Defines the template of the task label to be printed, i.e., which data is included on the label and in which format. This section contains several settings that are described in the table <b>Label printout for task</b> below.	
Label printout for weighing item	Defines the template of the weighing item label to be printed, i.e., which data is included on the label and in which format. This section contains several settings that are described in the table <b>Label printout for weighing item</b> below.	
Label cutting	Defines if the labels should be cut after printing. <b>Per label:</b> Each label is cut once printed. <b>Per task:</b> The labels are cut when the task is complete. This setting is only relevant if the connected label printer can cut labels.	Off*   Per label   Per task

\* Factory setting

### 6.2.7.6.1 Strip printout and data export

#### Automatic data output

Parameter	Description	Values
Strip printer	Activates/Deactivates automatic printing of the <b>Results list</b> on a strip printer when the <b>Complete</b> button is tapped. The data to be transmitted to the printer can be defined in the section <b>Template settings</b> .	Active   Inactive*
Results export	Activates/Deactivates the automatic data export to a file server or USB storage device when the <b>Complete</b> button is tapped.	Active   Inactive*
Weight value	Activates/Deactivates the option to automatically send the weighing value over USB or Ethernet when tapping <b>Add result</b> .	Active   Inactive*

\* Factory setting

#### Strip printout template

This menu item can be used to define which information is printed by the strip printer.

Each individual parameter can be set to **Inactive** or **Active** via the corresponding check box. To enable or disable all parameters at once, proceed as follows:

- To disable all check boxes at once, tap  **Deselect all**.
  - ➔ All parameters are set to **Inactive**.
- To enable all check boxes at once, tap  **Select all**.
  - ➔ All parameters are set to **Active**.

## Template settings

Parameter	Description	Values
Header and Footer	Defines the header and/or footer to be printed.	Title   Title text   Date/time   User   Signature   Separating lines   Group titles
Balance information	Defines which information about the balance is printed.	Balance type   Balance ID   Balance serial number   Software version
Quality information	Defines which quality information is printed.	Tolerance profile   Adjustment date/time   Routine test name   Routine test last execution date   Routine test result   GWP Approved state   Level state   MinWeigh state
Task information	Defines which information about the task is printed.	Method name   Method comment   Task IDs   Automatic result settings   Count   Sum   Average   Minimum   Maximum   Standard deviation   Relative standard deviation   PCS below -Tolerance   PCS above +Tolerance
Weighing item information	Defines which information about the weighing items is printed.	Show excluded weighing items   Result state   Result IDs   GWP Approved state   Level state   MinWeigh state   Tolerance state   Target and tolerances   Reference PCS   Reference average weight
Result detail information	Defines which information related to the result of the measurement is printed.	Weight   Tare weight   Gross weight   Info weight   Date/time   Stability

### 6.2.7.6.2 Label printout for task

Parameter	Description	Values
Automatic label printout for task	When set to <b>Active</b> , the task label is automatically printed when tapping <b>Complete</b> .	Active   Inactive*
Copies	Defines how many copies of the label are printed.	Numeric
Used template	Chooses the label template.	Available labels are shown below.

\* Factory setting

## Field settings

The content of each label field can be defined individually.

Parameter	Description	Values
Label field 1	Defines which information appears in each label field. The number of label fields depends on the selected template.	Available entries depend on the method settings.

## Barcode settings

The content of each barcode field can be defined individually. This section is only available when the selected **Used template** contains at least one 2D code.

Parameter	Description	Values
Delimiter	Defines the delimiter between the barcode entries. This setting is only available when the selected <b>Used template</b> contains several 2D codes.	TAB*   Form feed   Carriage return   Space   User defined
Barcode field 1	Defines which information appears in each barcode. The number of the barcode fields depends on the selected template.	Available entries depend on the method settings.

\* Factory setting

### 6.2.7.6.3 Label printout for weighing item

Parameter	Description	Values
Automatic label printout for weighing item	When set to <b>Active</b> , the weighing item label is automatically printed when tapping <b>Add result</b> .	Active   Inactive*
Copies	Defines how many copies of the label are printed.	Numeric
Used template	Chooses the label template.	Available labels are shown below.

\* Factory setting

## Field settings

The content of each label field can be defined individually.

Parameter	Description	Values
Label field 1	Defines which information appears in each label field. The number of label fields depends on the selected template.	Available entries depend on the method settings.

## Barcode settings







The content of each barcode field can be defined individually. This section is only available when the selected **Used template** contains at least one 2D code.

Parameter	Description	Values
Delimiter	Defines the delimiter between the barcode entries. This setting is only available when the selected <b>Used template</b> contains several 2D codes.	TAB*   Form feed   Carriage return   Space   User defined
Barcode field 1	Defines which information appears in each barcode. The number of the barcode fields depends on the selected template.	Available entries depend on the method settings.

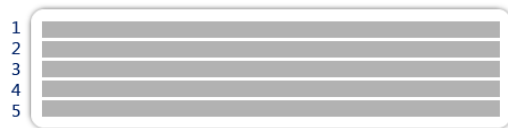
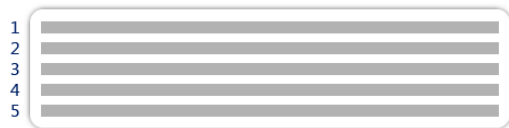
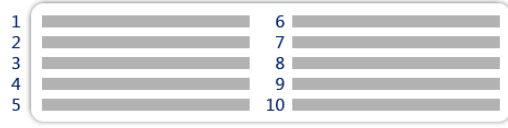
\* Factory setting

### 6.2.7.6.4 Available labels

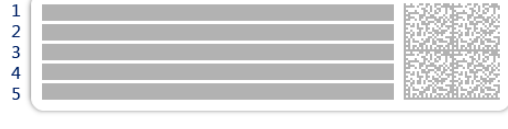
The following label layouts can be selected:

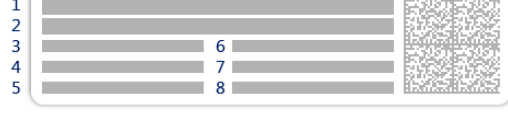
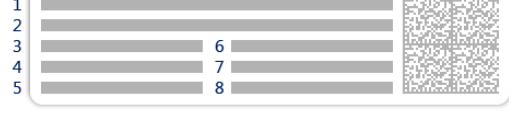
 <p>1 2 3 4 5</p> <p>5 large fields</p>	 <p>1 2 3 4 5</p> <p>5 small fields</p>
 <p>1 2 3 4 5</p> <p>6 7 8 9 10</p> <p>10 small fields</p>	 <p>1 2 3</p> <p>1D barcode with 3 large fields</p>
 <p>1 2 3</p> <p>1D barcode with 3 small fields</p>	 <p>1 2 3</p> <p>4 5 6</p> <p>1D barcode with 6 small fields</p>
 <p>1 2 3 4 5</p> <p>2D barcode with 5 large fields</p>	 <p>1 2 3 4 5</p> <p>2D barcode with 5 small fields</p>
 <p>1 2 3 4 5</p> <p>6 7 8</p> <p>2D barcode with 2 large fields and 6 small fields</p>	 <p>1 2 3 4 5</p> <p>6 7 8</p> <p>2D barcode with 8 small fields</p>

## 6.2.8 Settings: method "Automated dosing"

The settings described in this section are only available for automatic balances. Which settings are available depends on which products are installed on your balance:

- Q3 dosing module
- QLX3 liquid module
- QS3 sample changer

Navigation: **Methods** > **Methods list** > **my automated dosing** > **Edit**

Edit method - my automated dosing	
General	Method type: Automated dosing
Dosing	Method name: my automated dosing
ID format	Comment: <i>Enter here</i>
Weighing	
Weighing item	Lock method: <input type="checkbox"/>
Automation	
Print / Export	
Close	Save

The settings of the method **Automated dosing** are grouped as follows:

- **General**
- **Dosing**
- **ID format**
- **Weighing**
- **Weighing item**, only available for the method **Automated dosing**
- **Weighing items**, only available for the method **Automated dosing (itemized)**
- **Automation**
- **Print / Export**

### See also

- [Creating a method "Automated dosing" ▶ Page 54](#)
- [Editing a method ▶ Page 63](#)

### 6.2.8.1 General

The **Method type** is defined in the wizard while creating the method and cannot be changed.

Parameter	Description	Values
Method name	Defines the name of the method.	Text (1...22 characters)
Comment	The method can be described with a comment.	Text (0...128 characters)
Lock method	Locks the method to prevent further editing.	Active   Inactive*

\* Factory setting

### 6.2.8.2 Dosing

Parameter	Description	Values
HeightDetect	Defines if the height of the vessel opening is detected automatically using the optical sensor of the Q3 dosing module.	Active*   Inactive



Allow fine adjustment	Enables/Disables the possibility to manually apply fine adjustment on the dosing height after <b>HeightDetect</b> has been performed. This setting is only available when <b>HeightDetect</b> is set to <b>Active</b> .	Active   Inactive*
Safe position	This option moves the dosing head to a safe position after each dosing operation and prevents it from touching the vessel. This position is approximately 15 mm above the dosing position. This setting is only available if <b>HeightDetect</b> is set to <b>Inactive</b> . If <b>HeightDetect</b> is set to <b>Active</b> , the <b>Safe position</b> is automatically used.	Active*   Inactive
Number of samples	Defines the number of samples. This setting is only available if a sample changer is connected to the balance.	Numeric (30*   1...300)

\* Factory setting

For more information about setting up the height of the dosing head, see [Setting the height of the dosing head ▶ Page 97].

#### See also

[Creating a method "Automated dosing" ▶ Page 54](#)

### 6.2.8.3 ID format

#### Task IDs

Parameter	Description	Values
Number of task IDs	Defines the number of task IDs. If the <b>Number of task IDs</b> is larger than 0, the settings <b>Task ID</b> , <b>Task description</b> and <b>Prefix/Default value</b> are available for every single task ID.	0   1*   2   3
Task ID 1	Defines the naming type of the task ID. <b>Manual with default:</b> The value of the task ID can be entered manually at method execution time. <b>Automatic timestamp:</b> The system provides a value created from a prefix with the current date and time appended.	Manual with default*   Automatic timestamp
Task description	Allows to define a label for each task ID field.	Text (0...32 characters)
Default value	Defines a default value for the task ID. The value of the task ID can be changed manually while executing the method. This setting is only available when the corresponding <b>Task ID</b> is set to <b>Manual with default</b> .	Text (0...32 characters)
Prefix	Defines a prefix for the task ID. This setting is only available is the corresponding <b>Task ID</b> is set to <b>Automatic timestamp</b> .	Text (0...32 characters)

\* Factory setting

#### Result IDs

Parameter	Description	Values
Number of result IDs	Defines the number of result IDs. If the <b>Number of result IDs</b> is larger than 0, the settings <b>Result ID</b> , <b>Result description</b> and <b>Prefix/Default value</b> are available for every single result ID.	0   1*   2   3

Result ID 1	<p>Defines the naming type of the result ID.</p> <p><b>Manual with default:</b> The value for the <b>Result ID</b> can be entered manually at method execution time.</p> <p><b>Automatic counter:</b> The system provides a value created from a prefix with an unique number (counter) appended.</p> <p><b>From RFID tag:</b> The value for the <b>Result ID</b> is copied from the dosing head data.</p>	Manual with default*   Automatic counter   From RFID tag
Result description	Allows to define a label for each result ID.	Text (0...32 characters)
Default value	<p>Defines a default value for the result ID. The value of the result ID can be changed manually while executing the method.</p> <p>This setting is only available when the corresponding <b>Result ID</b> is set to <b>Manual with default</b>.</p>	Text (0...32 characters)
Prefix	<p>Defines a prefix for the result ID.</p> <p>This setting is only available if the corresponding <b>Result ID</b> is set to <b>Automatic counter</b>.</p>	Text (0...32 characters)
RFID tag field	<p>Defines which field of the RFID tag will be stored in the specified <b>Result ID</b>.</p> <p>This setting is only available if the corresponding result ID is set to <b>From RFID tag</b>.</p>	Substance   Lot name

\* Factory setting

#### 6.2.8.4 Weighing

Parameter	Description	Values
Show info weight	When set to <b>Active</b> , a secondary weight is displayed on the weighing screen.	Active   Inactive*
Info unit	<p>Defines the unit of the <b>Info weight</b>.</p> <p>This setting is only available if <b>Show info weight</b> is set to <b>Active</b>.</p>	The available units depend on the balance model.

\* Factory setting

#### Weighing settings

Parameter	Description	Values
Tolerance profile	A tolerance profile stores all the necessary balance settings needed for a certain weighing method. It is possible to create different tolerance profiles for different weighing methods.	Tolerance profiles are created by the user for specific balances and applications.
Tolerance profile (liquid)	When weighing liquids, a maximum of four digits can be used for the weight. Otherwise, the balance will not be able to reach a stable result. If you are using a balance with more than 4 digits, set up a specific tolerance profile to use when weighing liquids, with appropriate value of <b>Display readability</b> .	Tolerance profiles are created by the user for specific balances and applications.

\* Factory setting

## Statistics

Parameter	Description	Values
Activate statistics	<p>If <b>Activate statistics</b> is set to <b>Active</b>, the following statistics will be calculated:</p> <p><b>Count:</b> Number of items used for the statistics</p> <p><b>Sum:</b> sum of all value (decimal places and unit according to the method settings)</p> <p><b>Minimum:</b> smallest value (decimal places and unit according to the method settings)</p> <p><b>Maximum:</b> largest value (decimal places and unit according to the method setting)</p> <p><b>Range:</b> difference between the largest and smallest values (decimal places and unit according to the method settings)</p> <p><b>Average:</b> The values are summed up and divided by the number of values, rounded to 1 digit more than the configured decimal places in the associated tolerance profile (unit according to the method settings).</p> <p><b>Standard deviation:</b> standard deviation rounded to 1 digit more than the configured decimal places in the associated tolerance profile (unit according to the method settings)</p> <p><b>Relative standard deviation:</b> relative standard deviation (rounded to 2 decimal places, in %)</p> <p>The statistical values are calculated and displayed as soon as a result is added or updated.</p>	Active   Inactive*

\* Factory setting

## Electrostatic

Parameter	Description	Values
Ionizer	Defines whether the ionizer is activated/deactivated.	Active   Inactive*
Detection	Activates or deactivates electrostatic detection (StaticDetect). This setting is not available if a QS3 sample changer is installed on the balance.	Active   Inactive*
Threshold	<p>Defines the maximum acceptable weighing error due to electrostatic charges.</p> <p>If the measured approximate weighing error is smaller or equal to the detection threshold, the StaticDetect state is <b>OK</b>.</p> <p>If the measured approximate weighing error is larger than the detection threshold, the StaticDetect state is <b>Not OK</b>.</p> <p>This setting is only available if <b>Detection</b> is set to <b>Active</b>.</p>	Numeric
Show weighing error	<p>Displays the weighing error or not.</p> <p><b>Active:</b> If the StaticDetect value is above the threshold, the effective approximate weighing error is displayed.</p> <p>This setting is only available if <b>Detection</b> is <b>Active</b>.</p>	Active*   Inactive

\* Factory setting

## See also

[Creating a method "Automated dosing" ▶ Page 54](#)

### 6.2.8.5 Weighing item / Weighing items

A target weight with tolerance limits can be defined for the method. The method **Automated dosing** includes a single item in **Weighing item**, whereas several items can be defined for the method **Automated dosing (itemized)** in **Weighing items**.

Parameter	Description	Values
Sample ID	Defines the name of the sample. This setting is only available for methods containing several weighing items (itemized).	Text (0...32 characters)
Substance	Defines the name of the substance that is to be dosed. The user can write the name manually. Alternatively, tap the button  to use the data stored on the dosing head. <b>Note</b> The name of the substance on the dosing head must be exactly the same as the name of the substance used as setting in the method.	Text (0...20 characters)
Unit	Defines the unit of the weighing result.	The available units depend on the balance model.
Target weight	Defines the target weight. The target weight will be shown in the weighing-in aid of the balance (SmartTrac). When a target weight including tolerances is defined, the SmartTrac indicates if the current display weight is in tolerance or not.	Numeric
-Tolerance	Defines the lower tolerance limit. This setting is only available if a <b>Target weight</b> is defined.	Numeric
+Tolerance	Defines the upper tolerance limit. This setting is only available if a <b>Target weight</b> is defined.	Numeric

\* Factory setting

#### See also

 [Creating a method "Automated dosing" ▶ Page 54](#)

### 6.2.8.6 Automation

Parameter	Description	Values
Barcode data target	If a barcode reader is connected to the balance, this option defines how the data is to be processed. <b>Keyboard Input:</b> The data is written in the currently open input window. If no input window is open, the data is ignored. <b>Target weight value:</b> The barcode data is interpreted as a value for the target weight. <b>Task ID 1:</b> The received barcode data is treated as identification text for this task ID. <b>Result ID 1:</b> The received barcode data is treated as identification text for this result ID. The available items in the drop-down menu depend on the <b>Number of task IDs</b> and <b>Number of result IDs</b> specified for the method. Make sure that the characters of the scanned barcode are compatible with the format of the field where they should be inserted.	Keyboard Input*   Target weight value   Task ID 1   Result ID 1   ...

## Weighing automation

Parameter	Description	Values
Automatic task completion	<b>Active:</b> the balance automatically completes a running task after the result of the last weighing item has been added to the <b>Results list</b> . This setting is only available if the method is using multiple weighing items.	Active   Inactive*

\* Factory setting

### 6.2.8.7 Print / Export

Parameter	Description	Values
Strip printout and data export	Defines the content of the printout and/or export, as well as which printing/exporting actions are performed automatically when the task is complete. This section contains several settings that are described in the table <b>Strip printout and data export</b> below.	
Label printout for task	Defines the template of the task label to be printed, i.e., which data is included on the label and in which format. This section contains several settings that are described in the table <b>Label printout for task</b> below.	
Label printout for weighing item	Defines the template of the weighing item label to be printed, i.e., which data is included on the label and in which format. This section contains several settings that are described in the table <b>Label printout for weighing item</b> below.	
Label cutting	Defines if the labels should be cut after printing. <b>Per label:</b> Each label is cut once printed. <b>Per task:</b> The labels are cut when the task is complete. This setting is only relevant if the connected label printer can cut labels.	Off*   Per label   Per task

\* Factory setting

#### 6.2.8.7.1 Strip printout and data export

##### Automatic data output

Parameter	Description	Values
Strip printer	Activates/Deactivates automatic printing of the <b>Results list</b> on a strip printer when the <b>Complete</b> button is tapped. The data to be transmitted to the printer can be defined in the section <b>Template settings</b> .	Active   Inactive*
Results export	Activates/Deactivates the automatic data export to a file server or USB storage device when the <b>Complete</b> button is tapped.	Active   Inactive*
Weight value	Activates/Deactivates the option to automatically send the weighing value over USB or Ethernet when tapping <b>Add result</b> .	Active   Inactive*

\* Factory setting

##### Strip printout template

This menu item can be used to define which information is printed by the strip printer.

Each individual parameter can be set to **Inactive** or **Active** via the corresponding check box. To enable or disable all parameters at once, proceed as follows:

- To disable all check boxes at once, tap  **Deselect all**.

→ All parameters are set to **Inactive**.

2 To enable all check boxes at once, tap  **Select all**.

→ All parameters are set to **Active**.

### Template settings

Parameter	Description	Values
Header and Footer	Defines the header and/or footer to be printed.	Title   Title text   Date/time   User   Signature   Separating lines   Group titles
Balance information	Defines which information about the balance is printed.	Balance type   Balance ID   Balance serial number   Software version
Quality information	Defines which quality information is printed.	Tolerance profile   Tolerance profile (liquid)   Adjustment date/time   Routine test name   Routine test last execution date   Routine test result   GWP Approved state   Level state   MinWeigh state
Task information	Defines which information about the task is printed.	Method name   Method comment   Task IDs   Count   Sum   Average   Minimum   Maximum   Range   Standard deviation   Relative standard deviation   Average dosing time
Dosing head information	Defines which information about the dosing head is printed.	Substance   Lot ID   Expiry date   Filling date   Label and value 1   Label and value 2   Label and value 3   Molar mass   Purity   Liquid density   Dosing head type   Dosing head ID
Weighing item information	Defines which information about the weighing items is printed.	Show excluded weighing items   Result state   Result IDs   Sample position   GWP Approved state   Level state   MinWeigh state   Tolerance state   Target and tolerances
Result detail information	Defines which information related to the result of the measurement is printed.	Weight   Tare weight   Gross weight   Info weight   Date/time   Dosing duration   Stability

### 6.2.8.7.2 Label printout for task

Parameter	Description	Values
Automatic label printout for task	When set to <b>Active</b> , the task label is automatically printed when tapping <b>Complete</b> .	Active   Inactive*
Copies	Defines how many copies of the label are printed.	Numeric
Used template	Chooses the label template.	Available labels are shown below.

\* Factory setting

#### Field settings

The content of each label field can be defined individually.

Parameter	Description	Values
Label field 1	Defines which information appears in each label field. The number of label fields depends on the selected template.	Available entries depend on the method settings.

#### Barcode settings

The content of each barcode field can be defined individually. This section is only available when the selected **Used template** contains at least one 2D code.

Parameter	Description	Values
Delimiter	Defines the delimiter between the barcode entries. This setting is only available when the selected <b>Used template</b> contains several 2D codes.	TAB*   Form feed   Carriage return   Space   User defined
Barcode field 1	Defines which information appears in each barcode. The number of the barcode fields depends on the selected template.	Available entries depend on the method settings.

\* Factory setting

### 6.2.8.7.3 Label printout for weighing item

Parameter	Description	Values
Automatic label printout for weighing item	When set to <b>Active</b> , the weighing item label is automatically printed when tapping <b>Add result</b> .	Active   Inactive*
Copies	Defines how many copies of the label are printed.	Numeric
Used template	Chooses the label template.	Available labels are shown below.

\* Factory setting

#### Field settings

The content of each label field can be defined individually.

Parameter	Description	Values
Label field 1	Defines which information appears in each label field. The number of label fields depends on the selected template.	Available entries depend on the method settings.

#### Barcode settings

The content of each barcode field can be defined individually. This section is only available when the selected **Used template** contains at least one 2D code.







Parameter	Description	Values
Delimiter	Defines the delimiter between the barcode entries. This setting is only available when the selected <b>Used template</b> contains several 2D codes.	TAB*   Form feed   Carriage return   Space   User defined

Barcode field 1	Defines which information appears in each barcode. The number of the barcode fields depends on the selected template.	Available entries depend on the method settings.
-----------------	---	--

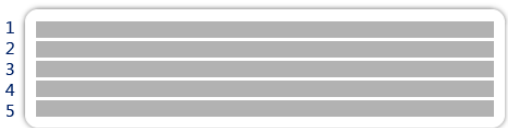
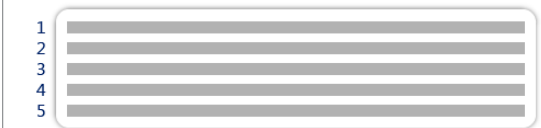
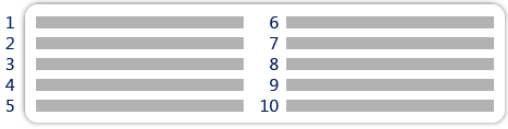
\* Factory setting

#### 6.2.8.7.4 Available labels

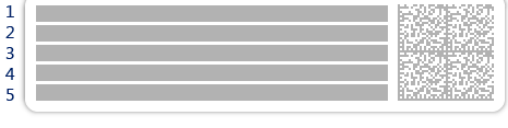
The following label layouts can be selected:

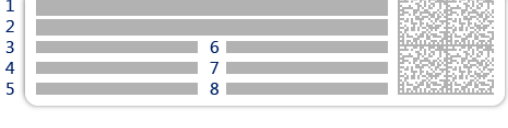
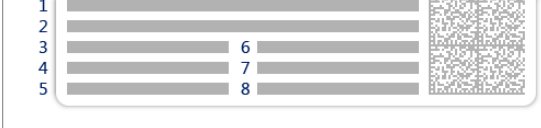
 <p>1 2 3 4 5</p> <p>5 large fields</p>	 <p>1 2 3 4 5</p> <p>5 small fields</p>
 <p>1 2 3 4 5</p> <p>6 7 8 9 10</p> <p>10 small fields</p>	 <p>1 2 3</p> <p>1D barcode with 3 large fields</p>
 <p>1 2 3</p> <p>1D barcode with 3 small fields</p>	 <p>1 2 3</p> <p>4 5 6</p> <p>1D barcode with 6 small fields</p>
 <p>1 2 3 4 5</p> <p>2D barcode with 5 large fields</p>	 <p>1 2 3 4 5</p> <p>2D barcode with 5 small fields</p>
 <p>1 2 3 4 5</p> <p>6 7 8</p> <p>2D barcode with 2 large fields and 6 small fields</p>	 <p>1 2 3 4 5</p> <p>6 7 8</p> <p>2D barcode with 8 small fields</p>

#### 6.2.9 Settings: method "Automated solution prep."

The settings described in this section are only available for automatic balances. Which settings are available depends on which products are installed on your balance:

- Q3 dosing module
- QLX3 liquid module
- QS3 sample changer



The settings of the method **Automated solution prep.** are grouped as follows:

- ☰ **General**
- 📄 **Solution**
- 📄 **ID format**
- ⚙️ **Weighing**
- ⚙️ **Weighing item**, only available for the method **Automated solution prep.**
- ⚙️ **Weighing items**, only available for the method **Automated solution prep. (itemized)**
- ⚙️ **Automation**
- 🖨️ **Print / Export**

**See also**

- 🔗 [Creating a method "Automated solution prep."](#) ▶ Page 59
- 🔗 [Editing a method](#) ▶ Page 63

**6.2.9.1 General**

The **Method type** is defined in the wizard while creating the method and cannot be changed.

Parameter	Description	Values
Method name	Defines the name of the method.	Text (1...22 characters)
Comment	The method can be described with a comment.	Text (0...128 characters)
Lock method	Locks the method to prevent further editing.	Active   Inactive*

\* Factory setting

**6.2.9.2 Solution**

Parameter	Description	Values
HeightDetect	Defines if the height of the vessel opening is detected automatically using the optical sensor of the Q3 dosing module.	Active*   Inactive
Allow fine adjustment	Enables/Disables the possibility to manually apply fine adjustment on the dosing height after <b>HeightDetect</b> has been performed.  This setting is only available when <b>HeightDetect</b> is set to <b>Active</b> .	Active   Inactive*

Safe position	This option moves the dosing head to a safe position after each dosing operation and prevents it from touching the vessel. This position is approximately 15 mm above the dosing position. This setting is only available if <b>HeightDetect</b> is set to <b>Inactive</b> . If <b>HeightDetect</b> is set to <b>Active</b> , the <b>Safe position</b> is automatically used.	Active*   Inactive
Number of samples	Defines the number of samples. This setting is only available if a sample changer is connected to the balance.	Numeric (30*   1... 300)

\* Factory setting

For more information about setting up the height of the dosing head, see [Setting the height of the dosing head ► Page 97].

## Solution

Parameter	Description	Values
Type	Defines the type of solution to be prepared. <b>Dissolve</b> : A solute is dissolved in a solvent. <b>Dilute solution</b> : An initial solution is diluted using a solvent.	Dissolve*   Dilute solution
Concentration unit	Defines the concentration unit of the solution.	µg/g*   mg/g   g/g   ppm
Volumetric conc. unit	Defines the volumetric concentration unit of the solution. This setting is only available if the <b>Type</b> of the <b>Solution</b> is set to <b>Dissolve</b> .	None*   mol/l   mmol/l   µg/ml   mg/ml   g/ml   g/l
Target conc. type	Defines which type of concentration is used for the calculation of the target weight. <b>Gravimetric</b> : The target weight is calculated based on a concentration expressed in units of weight ( <b>Concentration unit</b> ). <b>Volumetric</b> : The target weight is calculated based on a concentration expressed in units of volume ( <b>Volumetric conc. unit</b> ). This setting is only available if <b>Volumetric conc. unit</b> is set to other than <b>None</b> .	Gravimetric*   Volumetric
Initial solution conc.	Defines the concentration of the initial solution. This setting is only available if the <b>Type</b> of the <b>Solution</b> is set to <b>Dilute solution</b> .	Numeric
Use density from dosing head	When enabled, the calculation of the volumetric concentration will be based on the liquid density stored in the dosing head. This setting is only available if <b>Volumetric conc. unit</b> is set to other than <b>None</b> and <b>Target conc. type</b> is set to <b>Gravimetric</b> .	Active   Inactive*
Check for overflow	After weighing <b>Component 1</b> , the quantity of <b>Component 2</b> is adjusted to reach the target concentration. If the actual weight of <b>Component 1</b> is more than 30% larger than the <b>Target weight</b> , the user is notified of a possible overflow, when this setting is enabled.	Active*   Inactive
Production date	Defines the production date. <b>Current date</b> : The production date is set automatically to the date when the weighing task is started. <b>Manual input</b> : The production date can be entered manually when starting the weighing task.	None*   Current date   Manual input

Expiry date	Defines the expiry date of the substance. <b>Period:</b> The expiry date is set automatically when starting the weighing task (expiry date = date when starting the weighing task + number of days defined in the field <b>Period</b> . <b>Manual input:</b> The expiry date can be entered manually when starting the weighing task.	None*   Period   Manual input
Period	Defines the period of the expiry date. This setting is only available if <b>Expiry date</b> is set to <b>Period</b> .	Numeric (1 day*   1...9999 days)

\* Factory setting

### Component 1

Parameter	Description	Values
Weighing type	Select how the corresponding component is weighed. <b>Automated dosing:</b> the corresponding component is dosed automatically <b>Manual weighing:</b> the corresponding component is weighed manually	Automated dosing*   Manual weighing

\* Factory setting

### See also

 [Creating a method "Automated solution prep." ▶ Page 59](#)

## 6.2.9.3 ID format

### Task IDs

Parameter	Description	Values
Number of task IDs	Defines the number of task IDs. If the <b>Number of task IDs</b> is larger than 0, the settings <b>Task ID</b> , <b>Task description</b> and <b>Prefix/Default value</b> are available for every single task ID.	0   1*   2   3
Task ID 1	Defines the naming type of the task ID. <b>Manual with default:</b> The value of the task ID can be entered manually at method execution time. <b>Automatic timestamp:</b> The system provides a value created from a prefix with the current date and time appended.	Manual with default*   Automatic timestamp
Task description	Allows to define a label for each task ID field.	Text (0...32 characters)
Default value	Defines a default value for the task ID. The value of the task ID can be changed manually while executing the method. This setting is only available when the corresponding <b>Task ID</b> is set to <b>Manual with default</b> .	Text (0...32 characters)
Prefix	Defines a prefix for the task ID. This setting is only available is the corresponding <b>Task ID</b> is set to <b>Automatic timestamp</b> .	Text (0...32 characters)

\* Factory setting

### Result IDs

Parameter	Description	Values
Number of result IDs	Defines the number of result IDs. If the <b>Number of result IDs</b> is larger than 0, the settings <b>Result ID</b> , <b>Result description</b> and <b>Prefix/Default value</b> are available for every single result ID.	0   1*   2   3

Result ID 1	<p>Defines the naming type of the result ID.</p> <p><b>Manual with default:</b> The value for the <b>Result ID</b> can be entered manually at method execution time.</p> <p><b>Automatic counter:</b> The system provides a value created from a prefix with an unique number (counter) appended.</p> <p><b>From RFID tag:</b> The value for the <b>Result ID</b> is copied from the dosing head data.</p>	Manual with default*   Automatic counter   From RFID tag
Result description	Allows to define a label for each result ID.	Text (0...32 characters)
Default value	<p>Defines a default value for the result ID. The value of the result ID can be changed manually while executing the method.</p> <p>This setting is only available when the corresponding <b>Result ID</b> is set to <b>Manual with default</b>.</p>	Text (0...32 characters)
Prefix	<p>Defines a prefix for the result ID.</p> <p>This setting is only available if the corresponding <b>Result ID</b> is set to <b>Automatic counter</b>.</p>	Text (0...32 characters)
RFID tag field	<p>Defines which field of the RFID tag will be stored in the specified <b>Result ID</b>.</p> <p>This setting is only available if the corresponding result ID is set to <b>From RFID tag</b>.</p>	Component 1 - Substance*   Component 1 - Lot name   Component 2 - Substance   Component 2 - Lot name

\* Factory setting

#### 6.2.9.4 Weighing

Parameter	Description	Values
Show info weight	When set to <b>Active</b> , a secondary weight is displayed on the weighing screen.	Active   Inactive*
Info unit	<p>Defines the unit of the <b>Info weight</b>.</p> <p>This setting is only available if <b>Show info weight</b> is set to <b>Active</b>.</p>	The available units depend on the balance model.

\* Factory setting

#### Weighing settings

Parameter	Description	Values
Tolerance profile	A tolerance profile stores all the necessary balance settings needed for a certain weighing method. It is possible to create different tolerance profiles for different weighing methods.	Tolerance profiles are created by the user for specific balances and applications.
Tolerance profile (liquid)	When weighing liquids, a maximum of four digits can be used for the weight. Otherwise, the balance will not be able to reach a stable result. If you are using a balance with more than 4 digits, set up a specific tolerance profile to use when weighing liquids, with appropriate value of <b>Display readability</b> .	Tolerance profiles are created by the user for specific balances and applications.

\* Factory setting

#### Electrostatic

Parameter	Description	Values
Ionizer	Defines whether the ionizer is activated/deactivated.	Active   Inactive*
Detection	<p>Activates or deactivates electrostatic detection (StaticDetect).</p> <p>This setting is not available if a QS3 sample changer is installed on the balance.</p>	Active   Inactive*

Threshold	<p>Defines the maximum acceptable weighing error due to electrostatic charges.</p> <p>If the measured approximate weighing error is smaller or equal to the detection threshold, the StaticDetect state is <b>OK</b>.</p> <p>If the measured approximate weighing error is larger than the detection threshold, the StaticDetect state is <b>Not OK</b>.</p> <p>This setting is only available if <b>Detection</b> is set to <b>Active</b>.</p>	Numeric
Show weighing error	<p>Displays the weighing error or not.</p> <p><b>Active:</b> If the StaticDetect value is above the threshold, the effective approximate weighing error is displayed.</p> <p>This setting is only available if <b>Detection</b> is <b>Active</b>.</p>	Active*   Inactive

\* Factory setting

### See also

[Creating a method "Automated solution prep."](#) ▶ Page 59

## 6.2.9.5 Weighing item / Weighing items

The method **Automated solution prep.** includes a single item in **Weighing item**, whereas several items can be defined for the method **Automated solution prep. (itemized)** in **Weighing items**.

Parameter	Description	Values
Sample ID	<p>Defines the name of the sample.</p> <p>This setting is only available for methods containing several weighing items (itemized).</p>	Text (0...32 characters)

### Solution

Parameter	Description	Values
Target concentration	<p>Defines the target concentration of the solution.</p> <p>The units used to express the target concentration are either based on a weight (<b>Concentration unit</b>) or a volume (<b>Volumetric conc. unit</b>), as defined by <b>Target conc. type</b>.</p> <p>This setting is only available if the <b>Type</b> of <b>Solution</b> is set to <b>Dissolve</b>.</p>	Numeric
Dilution factor	<p>Defines the factor by which the concentration of the initial solution should be reduced.</p> <p>This setting is only available if the <b>Type</b> of <b>Solution</b> is set to <b>Dilute solution</b>.</p>	Numeric
±Conc. tolerance	<p>Defines the tolerance on the concentration of the solution.</p>	Numeric (1.0%*   0.001...100%)
Target weight	<p>Defines the total target weight for the solution.</p> <p>This setting is only available if the <b>Type</b> of <b>Solution</b> is set to <b>Dissolve</b>.</p> <p>The target of this method specified as <b>Target weight</b> if <b>Volumetric conc. unit</b> is set to <b>None</b> or <b>Target conc. type</b> is set to <b>Gravimetric</b>.</p>	Numeric
Target volume	<p>Defines the total target volume for the solution.</p> <p>This setting is only available if the <b>Type</b> of <b>Solution</b> is set to <b>Dissolve</b>.</p> <p>The target of this method specified as <b>Target volume</b> if <b>Volumetric conc. unit</b> is not set to <b>None</b> and <b>Target conc. type</b> is set to <b>Volumetric</b>.</p>	Numeric

Density	Defines the liquid density to be used for the calculation of the volumetric concentration. This setting is only available if <b>Volumetric conc. unit</b> is set to other than <b>None</b> and <b>Use density from dosing head</b> is set to <b>Inactive</b> .	Numeric (1.0000 g/ml*   0.01... 10 g/ml)
Component unit	Defines the weighing unit of <b>Component 1</b> .	List of available units

### Component 1

Parameter	Description	Values
Substance	Defines the name of the substance that is to be dosed. The user can write the name manually. Alternatively, tap the button  to use the data stored on the dosing head. <b>Note</b> The name of the substance on the dosing head must be exactly the same as the name of the substance used as setting in the method.	Text (0...20 characters)
Target weight	Shows the amount of <b>Component 1</b> required to obtain the desired solution. <b>Dissolve</b> : calculated based on the <b>Target concentration</b> and <b>Target weight</b> of the solution. <b>Dilute solution</b> : calculated based on the <b>Dilution factor</b> and the <b>Target weight</b> of the solution.	Numeric
-Tolerance	Defines the lower tolerance limit.	Numeric
+Tolerance	Defines the upper tolerance limit.	Numeric

### Component 2

Parameter	Description	Values
Substance	Defines the name of the substance that is to be dosed. The user can write the name manually. Alternatively, tap the button  to use the data stored on the dosing head. <b>Note</b> The name of the substance on the dosing head must be exactly the same as the name of the substance used as setting in the method.	Text (0...20 characters)

### See also

 [Creating a method "Automated solution prep."](#) ▶ Page 59

### 6.2.9.6 Automation

Parameter	Description	Values
Barcode data target	<p>If a barcode reader is connected to the balance, this option defines how the data is to be processed.</p> <p><b>Keyboard Input:</b> The data is written in the currently open input window. If no input window is open, the data is ignored.</p> <p><b>Target weight value:</b> The barcode data is interpreted as a value for the target weight.</p> <p><b>Task ID 1:</b> The received barcode data is treated as identification text for this task ID.</p> <p><b>Result ID 1:</b> The received barcode data is treated as identification text for this result ID.</p> <p>The available items in the drop-down menu depend on the <b>Number of task IDs</b> and <b>Number of result IDs</b> specified for the method.</p> <p>Make sure that the characters of the scanned barcode are compatible with the format of the field where they should be inserted.</p>	Keyboard Input*   Target weight value   Task ID 1   Result ID 1   ...

#### Weighing automation

Parameter	Description	Values
Automatic task completion	<p><b>Active:</b> the balance automatically completes a running task after the result of the last weighing item has been added to the <b>Results list</b>.</p> <p>This setting is only available if the method is using multiple weighing items.</p>	Active   Inactive*

\* Factory setting

### 6.2.9.7 Print / Export

Parameter	Description	Values
Strip printout and data export	<p>Defines the content of the printout and/or export, as well as which printing/exporting actions are performed automatically when the task is complete.</p> <p>This section contains several settings that are described in the table <b>Strip printout and data export</b> below.</p>	
Label printout for task	<p>Defines the template of the task label to be printed, i.e., which data is included on the label and in which format.</p> <p>This section contains several settings that are described in the table <b>Label printout for task</b> below.</p>	
Label printout for weighing item	<p>Defines the template of the weighing item label to be printed, i.e., which data is included on the label and in which format.</p> <p>This section contains several settings that are described in the table <b>Label printout for weighing item</b> below.</p>	
Label cutting	<p>Defines if the labels should be cut after printing.</p> <p><b>Per label:</b> Each label is cut once printed.</p> <p><b>Per task:</b> The labels are cut when the task is complete.</p> <p>This setting is only relevant if the connected label printer can cut labels.</p>	Off*   Per label   Per task

\* Factory setting

## 6.2.9.7.1 Strip printout and data export

### Automatic data output

Parameter	Description	Values
Strip printer	Activates/Deactivates automatic printing of the <b>Results list</b> on a strip printer when the <b>Complete</b> button is tapped. The data to be transmitted to the printer can be defined in the section <b>Template settings</b> .	Active   Inactive*
Results export	Activates/Deactivates the automatic data export to a file server or USB storage device when the <b>Complete</b> button is tapped.	Active   Inactive*
Weight value	Activates/Deactivates the option to automatically send the weighing value over USB or Ethernet when tapping <b>Add result</b> .	Active   Inactive*

\* Factory setting

### Strip printout template

This menu item can be used to define which information is printed by the strip printer.

Each individual parameter can be set to **Inactive** or **Active** via the corresponding check box. To enable or disable all parameters at once, proceed as follows:

- 1 To disable all check boxes at once, tap  **Deselect all**.  
 ➔ All parameters are set to **Inactive**.
- 2 To enable all check boxes at once, tap  **Select all**.  
 ➔ All parameters are set to **Active**.

### Template settings

Parameter	Description	Values
Header and Footer	Defines the header and/or footer to be printed.	Title   Title text   Date/time   User   Signature   Separating lines   Group titles
Balance information	Defines which information about the balance is printed.	Balance type   Balance ID   Balance serial number   Software version
Quality information	Defines which quality information is printed.	Tolerance profile   Tolerance profile (liquid)   Adjustment date/time   Routine test name   Routine test last execution date   Routine test result   GWP Approved state   Level state   MinWeigh state
Task information	Defines which information about the task is printed.	Method name   Method comment   Task IDs   Expiry date   Production date



Dosing head information (component 1)	Defines which information about the dosing head of the component 1 is printed.	Substance   Lot ID   Expiry date   Filling date   Label and value 1   Label and value 2   Label and value 3   Molar mass   Purity   Liquid density   Dosing head type   Dosing head ID
Dosing head information (component 2)	Defines which information about the dosing head of the component 2 is printed.	Substance   Lot ID   Expiry date   Filling date   Label and value 1   Label and value 2   Label and value 3   Molar mass   Purity   Liquid density   Dosing head type   Dosing head ID
Weighing item information	Defines which information about the weighing items is printed.	Show excluded weighing items   Result state   Result IDs   Concentration   Volumetric concentration   Concentration tolerance state   Target concentration   Dilution factor   Concentration tolerance   Weight   Target weight   Density   Sample position   GWP   Approved state   Level state   MinWeigh state   Tolerance state (component 1)   Target and tolerances (component 1)   Target (component 2)
Result information (component 1)	Defines which information related to the result of the measurement of the component 1 is printed.	Weight   Tare weight   Gross weight   Info weight   Date/time   Dosing duration   Purity   Molar mass   Stability
Result information (component 2)	Defines which information related to the result of the measurement of the component 2 is printed.	Weight   Tare weight   Gross weight   Info weight   Date/time   Dosing duration   Stability

#### 6.2.9.7.2 Label printout for task

Parameter	Description	Values
Automatic label printout for task	When set to <b>Active</b> , the task label is automatically printed when tapping <b>Complete</b> .	Active   Inactive*
Copies	Defines how many copies of the label are printed.	Numeric

Used template	Chooses the label template.	Available labels are shown below.
---------------	-----------------------------	-----------------------------------

\* Factory setting

### Field settings

The content of each label field can be defined individually.

Parameter	Description	Values
Label field 1	Defines which information appears in each label field. The number of label fields depends on the selected template.	Available entries depend on the method settings.

### Barcode settings

The content of each barcode field can be defined individually. This section is only available when the selected **Used template** contains at least one 2D code.

Parameter	Description	Values
Delimiter	Defines the delimiter between the barcode entries. This setting is only available when the selected <b>Used template</b> contains several 2D codes.	TAB*   Form feed   Carriage return   Space   User defined
Barcode field 1	Defines which information appears in each barcode. The number of the barcode fields depends on the selected template.	Available entries depend on the method settings.

\* Factory setting

### 6.2.9.7.3 Label printout for weighing item

Parameter	Description	Values
Automatic label printout for weighing item	When set to <b>Active</b> , the weighing item label is automatically printed when tapping <b>Add result</b> .	Active   Inactive*
Copies	Defines how many copies of the label are printed.	Numeric
Used template	Chooses the label template.	Available labels are shown below.

\* Factory setting

### Field settings

The content of each label field can be defined individually.

Parameter	Description	Values
Label field 1	Defines which information appears in each label field. The number of label fields depends on the selected template.	Available entries depend on the method settings.

### Barcode settings







The content of each barcode field can be defined individually. This section is only available when the selected **Used template** contains at least one 2D code.

Parameter	Description	Values
Delimiter	Defines the delimiter between the barcode entries. This setting is only available when the selected <b>Used template</b> contains several 2D codes.	TAB*   Form feed   Carriage return   Space   User defined
Barcode field 1	Defines which information appears in each barcode. The number of the barcode fields depends on the selected template.	Available entries depend on the method settings.

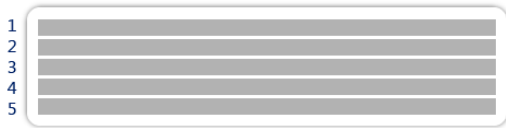
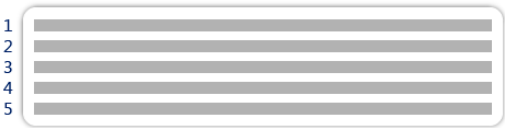
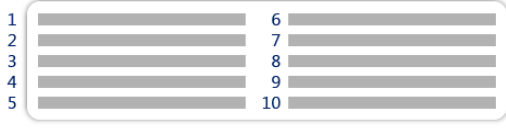
\* Factory setting

### 6.2.9.7.4 Available labels

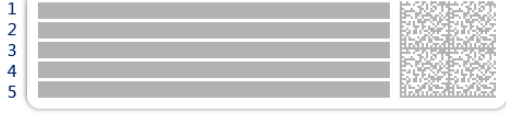
The following label layouts can be selected:

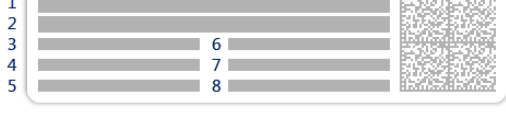
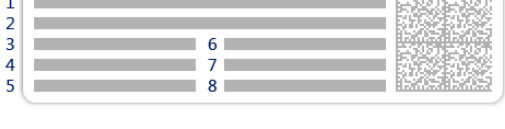
 <p>5 large fields</p>	 <p>5 small fields</p>
 <p>10 small fields</p>	 <p>1D barcode with 3 large fields</p>
 <p>1D barcode with 3 small fields</p>	 <p>1D barcode with 6 small fields</p>
 <p>2D barcode with 5 large fields</p>	 <p>2D barcode with 5 small fields</p>
 <p>2D barcode with 2 large fields and 6 small fields</p>	 <p>2D barcode with 8 small fields</p>

## 6.3 Test weights settings

### 6.3.1 Settings: individual test weight

Navigation: ▼ Methods > Tests > Test weights > my weight 1 > Edit

Parameter	Description	Values
Test weight name	Defines the name of the test weight.	Text (1...22 characters)
Test weight ID	Defines the test weight ID.	Text (1...22 characters)
Nominal weight	Defines the approximate, rounded value of the <b>Actual weight</b> .	Numeric

Weight class	Defines the weight class according to OIML or ASTM. Alternatively, a customized tolerance class can be created with <b>Own</b> .	E1   E2   F1   F2   M1   M2   M3   ASTM000   ASTM00   ASTM0   ASTM1   ASTM2   ASTM3   ASTM4   ASTM5   ASTM6   ASTM7   Own*
Actual weight	Defines the actual weight. The actual weight is a specific weight with a specific Conventional Mass Value (CMV) from the weight calibration certificate.	Numeric
Next calibration date	Defines the next date for calibration.	Date
Certificate	If the certificate of the test weight is available, set to <b>Active</b> and fill in the additional information related to the certificate (see below).	Active   Inactive*
Certificate ID	Defines the certificate ID. This setting is only available if <b>Certificate ID</b> is set to <b>Active</b> .	Text (1...22 characters)
Certificate date	Defines the certificate date. This setting is only available if <b>Certificate ID</b> is set to <b>Active</b> .	Date
Weight set ID	Defines the weight set ID.	Text (1...22 characters)

\* Factory setting

### 6.3.2 Settings: combined test weight

Navigation: **Methods** > **Tests** > **Test weights** > **my weight 1+2** > **Edit**

Parameter	Description	Values
Test weight name	Defines the name of the test weight.	Text (1...22 characters)
Nominal weight	Shows the sum of the nominal weights of all the individual weights included in this combined weight.	Numeric
Minimum weight class	Defines the minimum weight class according to OIML or ASTM. The customized tolerance class <b>Own</b> can also be selected. When choosing the weights that compose the combined weight, only the individual weights with a class better or equal to the selected <b>Minimum weight class</b> are shown.	E1   E2   F1   F2   M1   M2   M3   ASTM000   ASTM00   ASTM0   ASTM1   ASTM2   ASTM3   ASTM4   ASTM5   ASTM6   ASTM7   Own*
Weights	Displays a list of the available individual test weights. A total of two or three individual test weights can be selected. Only the individual weights with a class better or equal to the selected <b>Minimum weight class</b> are shown.	List of individual test weights

\* Factory setting

## 6.4 Tests settings

### 6.4.1 Settings: Eccentricity

Navigation: **Methods** > **Tests** > **my eccentricity test** > **Edit**

#### 1. Name and type

Parameter	Description	Values
Test type	The test type has been pre-defined and cannot be changed in this menu.	Available test types

Name	Defines the name of the test.	Text (1...22 characters)
Test activated	Enables/disables the test.	Active*   Inactive
Show preparation instructions	If activated, a predefined preparatory instruction is displayed in the test sequence.	Active*   Inactive
Automatic print	When activated, the test results are immediately printed on the enabled strip printer after the test result has been calculated.	Active   Inactive*

\* Factory setting

## 2. Test specification

Parameter	Description	Values
Result calculation	Select whether the nominal weight or the conventional mass value (CMV) is used for the result calculation.  <b>On nominal weight:</b> Nominal value of a weight with a specific weight class.  <b>On actual weight (CMV):</b> Conventional mass value (CMV) of a weight from the weight calibration certificate.	On nominal weight*   On actual weight (CMV)

\* Factory setting

### Test point

Parameter	Description	Values
Nominal weight	Defines the nominal value of the weight that will be used for the test.	Numeric
Weight class	Defines the weight class according to OIML or ASTM. Alternatively, a customized tolerance class can be created with <b>Own</b> .	E1   E2   F1   F2   M1   M2   M3   ASTM000   ASTM00   ASTM0   ASTM1   ASTM2   ASTM3   ASTM4   ASTM5   ASTM6   ASTM7   Own*

\* Factory setting

### Eccentricity limits

Parameter	Description	Values
Control limit	Defines the error tolerance of a process with respect to its set value. Exceeding the <b>Control limit</b> is a violation of quality requirements and therefore requires a correction of the process.  Result if the <b>Control limit</b> is exceeded: The test failed, the balance is out of specification.	Numeric
Warning limit	Defines the upper or lower limit that, if exceeded or not reached, makes more stringent process monitoring necessary. The <b>Warning limit</b> must be smaller than the <b>Control limit</b> .  Result if the <b>Warning limit</b> is exceeded: The test is passed, but the difference is higher than expected.	Numeric

## 3. Test weights

A configured test weight can be selected. For information on test weights definition and settings, see [Test weights ▶ Page 65] and [Test weights settings ▶ Page 201].

#### 4. Error management

Parameter	Description	Values
Block balance	Defines the behavior of the balance if a test has failed. <b>Active:</b> The balance will be blocked after a specified number of failed tests. In this case, the balance cannot be used anymore until a user with the appropriate right unblocks the balance. <b>Inactive:</b> Blocking is not activated.	Active   Inactive*
Allowed number of retries	Defines the maximum allowed retries until the balance will be blocked. This setting is only available if <b>Block balance</b> is set to <b>Active</b> .	Numeric (3*   0...9)

\* Factory setting

#### 5. Test planning

Parameter	Description	Values
Planning type	Specifies the schedule for the test to be performed. <b>Manually:</b> The test is performed manually. <b>Daily:</b> A task is generated every day at the specified time. <b>Weekly:</b> A task is generated at least once a week. Additional days can be selected if required. <b>Monthly:</b> A task is generated every month at the specified day and time. <b>Quarterly:</b> A task is generated every three months at the specified time. <b>Annually:</b> A task is generated once a year at the specified time.	Manually*   Daily   Weekly   Monthly   Quarterly   Annually
Start time	Defines the time when the test is due. This setting is only available if <b>Planning type</b> is not set to <b>Manually</b> .	Time

\* Factory setting

#### Notification

This section does not appear when **Planning type** is set to **Manually**.

Parameter	Description	Values
(x) hours before test	Defines the number of hours before a notification informs about the upcoming planned test.	Different values depending on the selected frequency (Planning type).
Notification every (x) hours	Defines the time interval before the next notification is issued.	Different values depending on the selected frequency (Planning type).

#### Preferred days

This section only appears when **Planning type** is set to **Weekly**.

Parameter	Description	Values
Preferred days	Defines the preferred weekday for the execution of the test.	Monday*   Tuesday*   Wednesday*   Thursday*   Friday*   Saturday   Sunday

\* Factory setting

## Preferred day for execution

This section only appears when **Planning type** is set to **Monthly**.

Parameter	Description	Values
Day of the week	Defines the preferred day for execution of the test. If <b>None</b> is selected, the test will be scheduled for a month after the last execution.	None*   Monday   Tuesday   Wednesday   Thursday   Friday   Saturday   Sunday
Week of the month	Defines on which week of the month the test is performed. This setting is only available if <b>Day of the week</b> is not set to <b>None</b> .	First*   Second   Third   Fourth

\* Factory setting

## 6. Printing

Parameter	Description	Values
Header and Footer	Defines the header and/or footer to be printed.	Title   Title text   Date/time   User   Signature   Separating lines   Group titles
Balance information	Defines which information about the balance is printed.	Balance type   Balance ID   Balance serial number   Software version
Test summary	Defines which information about the test summary is printed.	Test type   Test name   Test result
Test details	Defines which test details are printed.	Test trigger   Leveling at start   Temperature   Preparation instructions   Test start (date / time)   Test end (date / time)   User name
Tare specification	Defines which information about the tare specification is printed. This section is only available for tests using a tare weight.	Tare name   Min. tare weight
Test weight	Defines which information about the test weight is printed.	Test weight ID   Weight class   Nominal weight   Actual weight   Weight set ID   Certificate ID   Certificate date   Next calibration date   Weight type   Minimum weight class   Used nominal weights   Used actual weights
Test limits	Defines which information about the test limits is printed.	Warning limit   Control limit
Measurements / Results	Defines which information about the measurements and the results is printed.	Weight   Deviation   State   Level state   Zero / Tare   Center deviation

## See also

- [Defining an individual test weight ▶ Page 65](#)
- [Defining a combined test weight ▶ Page 66](#)
- [Creating a new test ▶ Page 67](#)

## 6.4.2 Settings: Repeatability test

≡ Navigation: ▼ Methods > 📄 Tests > 📄 my repeatability test > ✎ Edit

### 1. Name and type

Parameter	Description	Values
Test type	The test type has been pre-defined and cannot be changed in this menu.	Available test types
Name	Defines the name of the test.	Text (1...22 characters)
Test activated	Enables/disables the test.	Active*   Inactive
Show preparation instructions	If activated, a predefined preparatory instruction is displayed in the test sequence.	Active*   Inactive
Automatic print	When activated, the test results are immediately printed on the enabled strip printer after the test result has been calculated.	Active   Inactive*

\* Factory setting

### 2. Test specification

Parameter	Description	Values
Result calculation	Select whether the nominal weight or the conventional mass value (CMV) is used for the result calculation. <b>On nominal weight:</b> Nominal value of a weight with a specific weight class. <b>On actual weight (CMV):</b> Conventional mass value (CMV) of a weight from the weight calibration certificate.	On nominal weight*   On actual weight (CMV)
Number of repetitions	Defines the number of weight measurements of a series.	Numeric (10*   2...15)

\* Factory setting

### Tare

This section only appears when **Test type** is set to **Repeatab. - Tare - 1 TP**.

Parameter	Description	Values
Tare name	Defines a name for the tare weight.	Text (1...22 characters)
Minimum tare weight	Defines the minimum weight for the tare container. The test is only continued if a tare container with at least this weight is placed on the balance.	Numeric

\* Factory setting

### Test point

Parameter	Description	Values
Nominal weight	Defines the nominal value of the weight that will be used for the test.	Numeric



Weight class	Defines the weight class according to OIML or ASTM. Alternatively, a customized tolerance class can be created with <b>Own</b> .	E1   E2   F1   F2   M1   M2   M3   ASTM000   ASTM00   ASTM0   ASTM1   ASTM2   ASTM3   ASTM4   ASTM5   ASTM6   ASTM7   Own*
--------------	--	--

\* Factory setting

### Test limits

Parameter	Description	Values
Control limit	Defines the error tolerance of a process with respect to its set value. Exceeding the <b>Control limit</b> is a violation of quality requirements and therefore requires a correction of the process. The minimum value is 40% of the balance readability. Result if the <b>Control limit</b> is exceeded: The test failed, the balance is out of specification.	Numeric
Warning limit	Defines the upper or lower limit that, if exceeded or not reached, makes more stringent process monitoring necessary. The <b>Warning limit</b> must be smaller than the <b>Control limit</b> . Result if the <b>Warning limit</b> is exceeded: The test is passed, but the difference is higher than expected.	Numeric

### 3. Test weights

A configured test weight can be selected. For information on test weights definition and settings, see [Test weights ▶ Page 65] and [Test weights settings ▶ Page 201].

### 4. Error management

Parameter	Description	Values
Block balance	Defines the behavior of the balance if a test has failed. <b>Active</b> : The balance will be blocked after a specified number of failed tests. In this case, the balance cannot be used anymore until a user with the appropriate right unblocks the balance. <b>Inactive</b> : Blocking is not activated.	Active   Inactive*
Allowed number of retries	Defines the maximum allowed retries until the balance will be blocked. This setting is only available if <b>Block balance</b> is set to <b>Active</b> .	Numeric (3*   0...9)

\* Factory setting

### 5. Test planning

Parameter	Description	Values
Planning type	Specifies the schedule for the test to be performed. <b>Manually</b> : The test is performed manually. <b>Daily</b> : A task is generated every day at the specified time. <b>Weekly</b> : A task is generated at least once a week. Additional days can be selected if required. <b>Monthly</b> : A task is generated every month at the specified day and time. <b>Quarterly</b> : A task is generated every three months at the specified time. <b>Annually</b> : A task is generated once a year at the specified time.	Manually*   Daily   Weekly   Monthly   Quarterly   Annually

Start time	Defines the time when the test is due. This setting is only available if <b>Planning type</b> is not set to <b>Manually</b> .	Time
------------	--	------

\* Factory setting

### Notification

This section does not appear when **Planning type** is set to **Manually**.

Parameter	Description	Values
(x) hours before test	Defines the number of hours before a notification informs about the upcoming planned test.	Different values depending on the selected frequency (Planning type).
Notification every (x) hours	Defines the time interval before the next notification is issued.	Different values depending on the selected frequency (Planning type).

### Preferred days

This section only appears when **Planning type** is set to **Weekly**.

Parameter	Description	Values
Preferred days	Defines the preferred weekday for the execution of the test.	Monday*   Tuesday*   Wednesday*   Thursday*   Friday*   Saturday   Sunday

\* Factory setting

### Preferred day for execution

This section only appears when **Planning type** is set to **Monthly**.

Parameter	Description	Values
Day of the week	Defines the preferred day for execution of the test. If <b>None</b> is selected, the test will be scheduled for a month after the last execution.	None*   Monday   Tuesday   Wednesday   Thursday   Friday   Saturday   Sunday
Week of the month	Defines on which week of the month the test is performed. This setting is only available if <b>Day of the week</b> is not set to <b>None</b> .	First*   Second   Third   Fourth

\* Factory setting

## 6. Printing

Parameter	Description	Values
Header and Footer	Defines the header and/or footer to be printed.	Title   Title text   Date/time   User   Signature   Separating lines   Group titles
Balance information	Defines which information about the balance is printed.	Balance type   Balance ID   Balance serial number   Software version

Test details	Defines which test details are printed.	Test trigger   Leveling at start   Temperature   Preparation instructions   Test start (date / time)   Test end (date / time)   User name
Tare specification	Defines which information about the tare specification is printed. This section is only available for tests using a tare weight.	Tare name   Min. tare weight
Test weight	Defines which information about the test weight is printed. This section is available for the following test types: <ul style="list-style-type: none"> <li>• <b>Repeatab. - 1 TP</b></li> <li>• <b>Repeatab. - Tare - 1 TP</b></li> </ul>	Test weight ID   Weight class   Nominal weight   Actual weight   Weight set ID   Certificate ID   Certificate date   Next calibration date   Weight type   Minimum weight class   Used nominal weights   Used actual weights
Test weight	Defines which information about the test weight is printed. This section is available for the following test types: <ul style="list-style-type: none"> <li>• <b>Auto. Repeat. - Tare - 1 TP</b></li> </ul>	Nominal weight   Dosing head type   Dosing head ID
Test limits	Defines which information about the test limits is printed.	Warning limit   Control limit
Measurements / Results	Defines which information about the measurements and the results is printed.	Weight   State   Level state   Zero / Tare

#### See also

- [🔗 Defining an individual test weight ▶ Page 65](#)
- [🔗 Defining a combined test weight ▶ Page 66](#)
- [🔗 Creating a new test ▶ Page 67](#)

### 6.4.3 Settings: Sensitivity test

☰ Navigation: ▼ Methods > 📄 Tests > 📄 my sensitivity test > ✎ Edit

#### 1. Name and type

Parameter	Description	Values
Test type	The test type has been pre-defined and cannot be changed in this menu.	Available test types
Name	Defines the name of the test.	Text (1...22 characters)
Test activated	Enables/disables the test.	Active*   Inactive
Show preparation instructions	If activated, a predefined preparatory instruction is displayed in the test sequence.	Active*   Inactive
Automatic print	When activated, the test results are immediately printed on the enabled strip printer after the test result has been calculated.	Active   Inactive*

\* Factory setting

## 2. Test specification

Parameter	Description	Values
Result calculation	Select whether the nominal weight or the conventional mass value (CMV) is used for the result calculation. <b>On nominal weight:</b> Nominal value of a weight with a specific weight class. <b>On actual weight (CMV):</b> Conventional mass value (CMV) of a weight from the weight calibration certificate.	On nominal weight*   On actual weight (CMV)

\* Factory setting

### Tare

This section only appears when the option **Test type** is set to **Sensitivity - Tare - 1 TP** or **Sensitivity - Tare - 2 TP**.

Parameter	Description	Values
Tare name	Defines a name for the tare weight.	Text (1...22 characters)
Minimum tare weight	Defines the minimum weight for the tare container. The test is only continued if a tare container with at least this weight is placed on the balance.	Numeric

### Test point

Depending on the selected test, the following options can be defined for one or two test points:

Parameter	Description	Values
Nominal weight	Defines the nominal value of the weight that will be used for the test.	Numeric
Weight class	Defines the weight class according to OIML or ASTM. Alternatively, a customized tolerance class can be created with <b>Own</b> .	E1   E2   F1   F2   M1   M2   M3   ASTM000   ASTM00   ASTM0   ASTM1   ASTM2   ASTM3   ASTM4   ASTM5   ASTM6   ASTM7   Own*
Control limit	Defines the error tolerance of a process with respect to its set value. Exceeding the <b>Control limit</b> is a violation of quality requirements and therefore requires a correction of the process. Result if the <b>Control limit</b> is exceeded: The test failed, the balance is out of specification.	Numeric
Warning limit	Defines the upper or lower limit that, if exceeded or not reached, makes more stringent process monitoring necessary. The <b>Warning limit</b> must be smaller than the <b>Control limit</b> . Result if the <b>Warning limit</b> is exceeded: The test is passed, but the difference is higher than expected.	Numeric

\* Factory setting

## 3. Test weights

A configured test weight can be selected. For information on test weights definition and settings, see [Test weights ▶ Page 65] and [Test weights settings ▶ Page 201].

#### 4. Error management

Parameter	Description	Values
Block balance	Defines the behavior of the balance if a test has failed. <b>Active:</b> The balance will be blocked after a specified number of failed tests. In this case, the balance cannot be used anymore until a user with the appropriate right unblocks the balance. <b>Inactive:</b> Blocking is not activated.	Active   Inactive*
Allowed number of retries	Defines the maximum allowed retries until the balance will be blocked. This setting is only available if <b>Block balance</b> is set to <b>Active</b> .	Numeric (3*   0...9)

\* Factory setting

#### 5. Test planning

Parameter	Description	Values
Planning type	Specifies the schedule for the test to be performed. <b>Manually:</b> The test is performed manually. <b>Daily:</b> A task is generated every day at the specified time. <b>Weekly:</b> A task is generated at least once a week. Additional days can be selected if required. <b>Monthly:</b> A task is generated every month at the specified day and time. <b>Quarterly:</b> A task is generated every three months at the specified time. <b>Annually:</b> A task is generated once a year at the specified time.	Manually*   Daily   Weekly   Monthly   Quarterly   Annually
Start time	Defines the time when the test is due. This setting is only available if <b>Planning type</b> is not set to <b>Manually</b> .	Time

\* Factory setting

#### Notification

This section does not appear when **Planning type** is set to **Manually**.

Parameter	Description	Values
(x) hours before test	Defines the number of hours before a notification informs about the upcoming planned test.	Different values depending on the selected frequency (Planning type).
Notification every (x) hours	Defines the time interval before the next notification is issued.	Different values depending on the selected frequency (Planning type).

#### Preferred days

This section only appears when **Planning type** is set to **Weekly**.

Parameter	Description	Values
Preferred days	Defines the preferred weekday for the execution of the test.	Monday*   Tuesday*   Wednesday*   Thursday*   Friday*   Saturday   Sunday

\* Factory setting

## Preferred day for execution

This section only appears when **Planning type** is set to **Monthly**.

Parameter	Description	Values
Day of the week	Defines the preferred day for execution of the test. If <b>None</b> is selected, the test will be scheduled for a month after the last execution.	None*   Monday   Tuesday   Wednesday   Thursday   Friday   Saturday   Sunday
Week of the month	Defines on which week of the month the test is performed. This setting is only available if <b>Day of the week</b> is not set to <b>None</b> .	First*   Second   Third   Fourth

\* Factory setting

## 6. Printing

Parameter	Description	Values
Header and Footer	Defines the header and/or footer to be printed.	Title   Title text   Date/time   User   Signature   Separating lines   Group titles
Balance information	Defines which information about the balance is printed.	Balance type   Balance ID   Balance serial number   Software version
Test summary	Defines which information about the test summary is printed.	Test type   Test name   Test result
Test details	Defines which test details are printed.	Test trigger   Leveling at start   Temperature   Preparation instructions   Test start (date / time)   Test end (date / time)   User name
Tare specification	Defines which information about the tare specification is printed. This section is only available for tests using a tare weight.	Tare name   Min. tare weight
Test weight	Defines which information about the test weight is printed.	Test weight ID   Weight class   Nominal weight   Actual weight   Weight set ID   Certificate ID   Certificate date   Next calibration date   Weight type   Minimum weight class   Used nominal weights   Used actual weights
Test limits	Defines which information about the test limits is printed.	Warning limit   Control limit
Measurements / Results	Defines which information about the measurements and the results is printed.	Weight   Deviation   State   Level state   Zero / Tare

### See also

- [Defining an individual test weight ▶ Page 65](#)
- [Defining a combined test weight ▶ Page 66](#)
- [Creating a new test ▶ Page 67](#)

## 6.5 Adjustments settings

Navigation: ▼ Methods > ⚙ Adjustments > ⚙ Internal adjustment > ✎ Edit

### 1. Strategy

Parameter	Description	Values
Strategy	Defines the type of adjustment to be performed. When <b>Strategy</b> is set to <b>No adjustment</b> or <b>External adjustment</b> , no other settings are available. For approved balances, this setting is set to <b>Internal adjustment</b> and cannot be edited.	Internal adjustment*   External adjustment   No adjustment
Automatic print	When activated, the adjustment results are immediately printed on the enabled strip printer after the result has been calculated.	Active   Inactive*

\* Factory setting

### 2. Specification

Parameter	Description	Values
"As found" test	At the start of the adjustment sequence, an internal sensitivity test is automatically performed to evaluate the current status. The test results are displayed and recorded.	Active   Inactive*
"As left" test	When the adjustment is complete, an internal sensitivity test is automatically performed. The test results are displayed and recorded.	Active   Inactive*

\* Factory setting

### Limits

These settings only appear when one of the options "**As found**" test or "**As left**" test is activated.

Parameter	Description	Values
Control limit	Defines the error tolerance of a process with respect to its set value. Exceeding the <b>Control limit</b> is a violation of quality requirements and therefore requires a correction of the process. Result if the <b>Control limit</b> is exceeded: The adjustment failed, the balance is out of specification.	Numeric (0.1%*   0.001...100%)
Warning limit	Defines the upper or lower limit that, if exceeded or not reached, makes more stringent process monitoring necessary. The <b>Warning limit</b> must be smaller than the <b>Control limit</b> . Result if the <b>Warning limit</b> is exceeded: The adjustment is passed, but the difference is higher than expected.	Numeric (0.001...100%)

\* Factory setting

### 3. Error management

Parameter	Description	Values
Block balance	Defines the behavior of the balance if the adjustment has failed. <b>Active:</b> The balance will be blocked after the adjustment has failed. In this case, the balance can not be used anymore until a user with the appropriate right unblocks the balance. <b>Inactive:</b> The balance will not be blocked.	Active   Inactive*

\* Factory setting

## 4. Planning

Parameter	Description	Values
Start after leveling	Defines if the internal adjustment starts after leveling.	Active   Inactive*
Start after temperature change	Defines if the internal adjustment starts automatically after a temperature change of 1°C. For approved balances, this setting is set to <b>Internal adjustment</b> and cannot be edited. This restriction does not apply to balances of type /AC.	Active*   Inactive
Schedule	Defines when the adjustment is being performed. It is possible to define between one and three start times per day. It can also be defined on which day(s) the adjustment is being performed.	Inactive   1 start time*   2 start times   3 start times
Start time 1	Defines the start time for the execution of the task. The number of start times to be defined is specified by <b>Schedule</b> .	Time
Preferred days	Defines the days for the scheduled adjustments. This setting is only available if <b>Schedule</b> is not set to <b>Inactive</b> .	Monday   Tuesday   Wednesday   Thursday   Friday   Saturday   Sunday

\* Factory setting

## 5. Printing

Parameter	Description	Values
Header and Footer	Defines the header and/or footer to be printed.	Title   Title text   Date/time   User   Signature   Separating lines   Group titles
Balance information	Defines which information about the balance is printed.	Balance type   Balance ID   Balance serial number   Software version
Adjustment summary	Defines which information about the adjustment summary is printed.	Adjustment type   Adjustment status   Balance adjusted
Adjustment details	Defines which adjustment details are printed.	Trigger   Cell temperature   Level state   Date/time   User name
Adjustment weight	Defines which information about the adjustment weight is printed. This section is only available if an external weight is used for the adjustment.	Test weight ID   Weight class   Nominal weight   Actual weight   Weight set ID   Certificate ID   Certificate date   Next calibration date   Weight type   Minimum weight class   Used nominal weights   Used actual weights
Adjustment limits	Defines which information about the adjustment limits is printed. This section is only available for internal adjustments.	Warning limit   Control limit
Measurements / Results	Defines which information about the measurements and the results is printed. The settings available in this section depends on the adjustment strategy.	Correction   Test deviation "as found"   Test deviation "as left"   Test result "as found"   Test result "as left"



**See also**

- [🔗 Defining an individual test weight ▶ Page 65](#)
- [🔗 Defining a combined test weight ▶ Page 66](#)
- [🔗 Editing an "Internal adjustment" ▶ Page 74](#)
- [🔗 Editing an "External adjustment" ▶ Page 75](#)

## 7 Maintenance

To guarantee the functionality of the balance and the accuracy of the weighing results, a number of maintenance actions must be performed by the user.

The appropriate maintenance interval depends on your standard operating procedure (SOP).

### 7.1 Maintenance tasks

Maintenance action	Recommended interval	Remarks
Performing an adjustment	<ul style="list-style-type: none"><li>• Daily</li><li>• After cleaning</li><li>• After leveling</li><li>• After changing the location</li></ul>	see "Adjustments"
Performing routine tests (eccentricity test, repeatability test, sensitivity test). METTLER TOLEDO recommends to at least perform a sensitivity test.	<ul style="list-style-type: none"><li>• After cleaning</li><li>• After assembling the balance</li><li>• After a software update</li><li>• Depending on your internal regulations (SOP)</li></ul>	see "Tests"
Cleaning	<ul style="list-style-type: none"><li>• After every use</li><li>• After changing the substance</li><li>• Depending on the degree of pollution</li><li>• Depending on your internal regulations (SOP)</li></ul>	see "Cleaning"
Updating the software	<ul style="list-style-type: none"><li>• Depending on your internal regulations (SOP).</li><li>• After a new software release.</li></ul>	see "Software update"

#### See also

[Adjustments](#) ▶ Page 74

[Tests](#) ▶ Page 66

[Cleaning](#) ▶ Page 216

[Software update](#) ▶ Page 220

### 7.2 Cleaning

#### 7.2.1 Disassembling for cleaning



#### **CAUTION**

##### **Injury due to sharp objects or broken glass**

Instrument components, e.g., glass, can break and lead to injuries.

- Always proceed with focus and care.

- 1 Open the top door (1) and pull it all the way back, outside of the rails of the side doors. Shortly before the top door drops out, you can feel a slight resistance. Just keep pulling a little bit tighter.

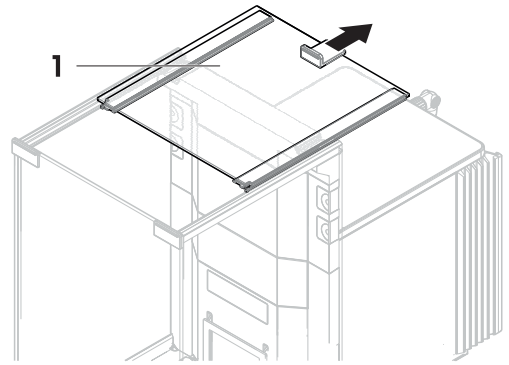

- 2 Hold the side doors (2) and push down the lever (3) to release them.
- 3 Carefully remove both side doors (2).

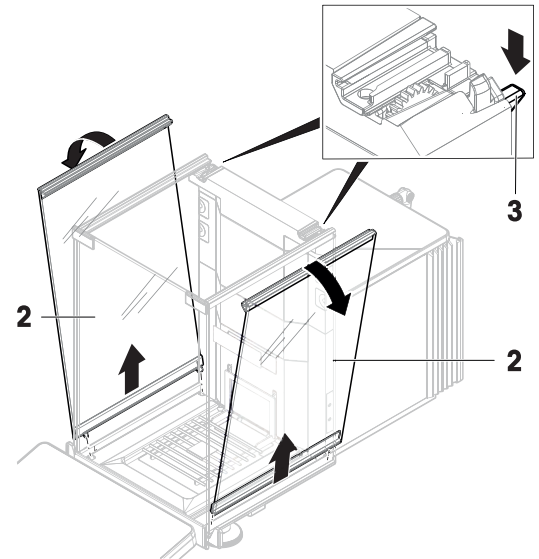

- 4 Tilt the front panel (4) to the front and remove it.

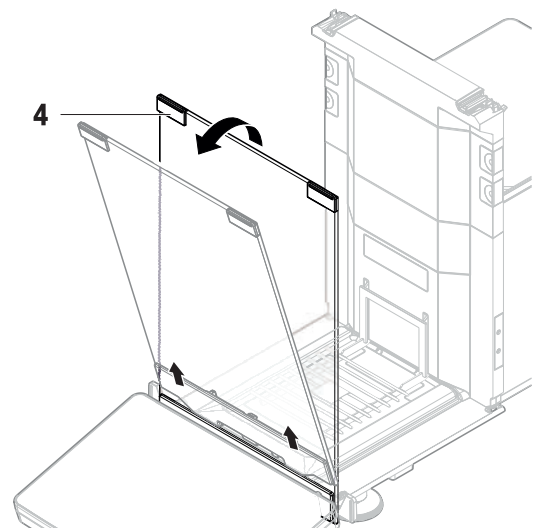

- 5 Carefully lift the weighing pan (5) to unhook it and pull it out.
  - 6 Remove the drip tray (6).
  - 7 Store all removed components in a safe place.
- ➔ The balance is ready for cleaning.

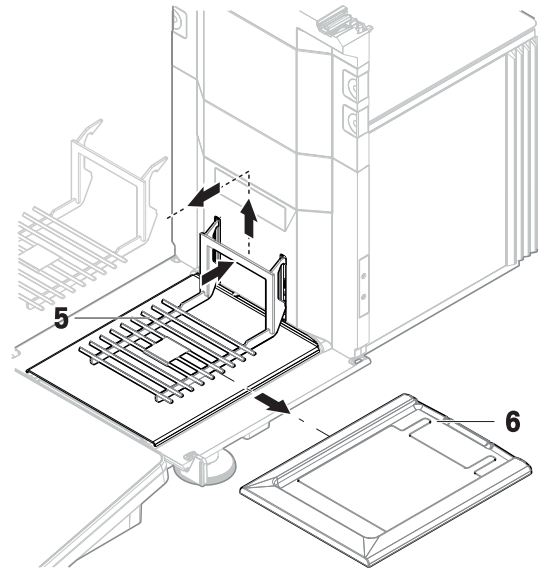

## 7.2.2 Cleaning agents

In the following table, cleaning tools and cleaning agents recommended by METTLER TOLEDO are listed. Pay attention to the concentration of the agents specified in the table.

		Tools				Cleaning agents						
		Paper tissue	Brush	Dishwasher	Water	Acetone	Ethanol (70%)	Isopropanol (70%)	Hydrochloric acid (3-10%)	Sodium hydroxide (0.2-1.0 M)	Peracetic acid (2-3%)	
Around the balance	Balance housing	✓	R	—	R	—	R	✓	R	R	R	
	Feet	✓	R	—	R	—	R	✓	R	R	R	
Balance terminal	Terminal	✓	R	—	✓	PR	R	R	R	R	R	
	Display	✓	—	—	✓	PR	R	R	R	R	R	
	Terminal cover	✓	R	—	✓	—	R	R	R	PR	PR	
Balance draft shield	Glass panels	✓	R	R	R	PR	✓	✓	R	R	R	
	Non-removable handles and frames	✓	R	—	R	PR	✓	✓	R	R	R	
Weighing area	Weighing pan	R	R	✓	R	R	✓	✓	R	R	R	
	Drip tray	R	R	✓	R	R	✓	✓	—	—	R	

### Legend

- ✓ Best recommendation by METTLER TOLEDO; can be used without limitation.
- R Recommended by METTLER TOLEDO; can be used without limitation.
- PR Partially recommended by METTLER TOLEDO: individual resistance to acid and alkali must be evaluated, including dependence to the time exposure.

- Not recommend. High risk for damage.

### 7.2.3 Cleaning the balance



#### NOTICE

##### Damage to the instrument due to inappropriate cleaning methods

If liquid enters the housing, it can damage the instrument. The surface of the instrument can be damaged by certain cleaning agents, solvents, or abrasives.

- 1 Do not spray or pour liquid on the instrument.
- 2 Only use the cleaning agents specified in the Reference Manual (RM) of the instrument or the guide "8 Steps to a Clean Balance".
- 3 Only use a lightly moistened, lint-free cloth or a tissue to clean the instrument.
- 4 Wipe off any spills immediately.



For further information on cleaning a balance, consult "8 Steps to a Clean Balance".

► [www.mt.com/lab-cleaning-guide](http://www.mt.com/lab-cleaning-guide)

#### Cleaning around the balance

- Remove any dirt or dust around the balance and avoid further contaminations.

#### Cleaning the terminal

- Clean the terminal with a damp cloth or a tissue and a mild cleaning agent.

#### Cleaning the removable parts

- Clean the removed part with a damp cloth or a tissue and a mild cleaning agent or clean in a dishwasher up to 80 °C.





#### Cleaning the balance

- 1 Disconnect the balance from the AC/DC adapter.
- 2 Use a lint-free cloth moistened with a mild cleaning agent to clean the surface of the balance.
- 3 Remove powder or dust with a disposable tissue first.
- 4 Remove sticky substances with a damp lint-free cloth and a mild solvent, e.g., isopropanol or ethanol 70%.

### 7.2.4 Putting into operation after cleaning

- 1 Reassemble the balance.
  - 2 Check that the draft shield doors (top, sides) open and close normally.
  - 3 Check if the terminal is connected to the balance.
  - 4 Reconnect the balance to the AC/DC adapter.
  - 5 Check the level status, level the balance if necessary.
  - 6 Respect the warm-up time specified in the "Technical Data".
  - 7 Perform an internal adjustment.
  - 8 Perform a routine test according to the internal regulations of your company. METTLER TOLEDO recommends performing a sensitivity test after cleaning the balance.
  - 9 Press **→0←** to zero the balance.
- ➔ The balance is ready to be used.

#### See also

-  Leveling the balance ▶ Page 33
-  Technical Data ▶ Page 225
-  Performing an internal adjustment ▶ Page 33
-  Performing a "Sensitivity test" ▶ Page 72

## 7.3 Service

Regular servicing by an authorized service technician ensures reliability for years to come. Contact your METTLER TOLEDO representative for details about the available service options.

## 7.4 Software update

Search for software:

▶ [www.mt.com/labweighing-software-download](http://www.mt.com/labweighing-software-download)

Contact a METTLER TOLEDO service representative if you need support updating the software. METTLER TOLEDO recommends saving the data on a storage device before updating the software.

☰ **Navigation:** ▶ **Balance menu** >  **Maintenance** >  **Software update**

#### See also

-  Exporting and importing settings ▶ Page 91

### 7.4.1 Updating the software

- A USB storage device containing the software installer (zip file format) is connected to the balance.
- 1 Tap  **Software update**.
- 2 Select **Update software** and tap **→Next**.
  - ➔ An update wizard opens and will lead you step-by-step through the procedure.

### 7.4.2 Restoring the software to the previous version

The current software version can be rolled back to the previous software version.

- 1 Tap  **Software update**.
- 2 Select **Restore the software to the previous version**. and tap **→ Next**.
  - ➔ An update wizard opens and will lead you step-by-step through the procedure.

### 7.4.3 Putting into operation after software update

- 1 Press  to switch on the balance.
  - 2 Check the level status, level the balance if necessary.
  - 3 Perform an internal adjustment.
  - 4 Perform a routine test according to the internal regulations of your company.
  - 5 Press **→0←** to zero the balance.
- ➔ The balance is ready to be used.

#### See also

-  Leveling the balance ▶ Page 33
-  Performing an internal adjustment ▶ Page 33

## 8 Troubleshooting

Possible errors with their cause and remedy are described in the following chapter. If there are errors that cannot be corrected through these instructions, contact METTLER TOLEDO.

### 8.1 Error messages

Error message	Possible cause	Diagnostic	Remedy
<b>Balance reset failed</b>	Communication failure	–	Disconnect the power cable and reconnect after a few seconds.
<b>The system has no valid date and time set</b>	Low battery	–	Connect to the power outlet and let the battery charge for two to three days.
<b>Weight cannot be determined</b>	Data signal problems of electronics.	–	Disconnect the power cable and reconnect after a few seconds.
	Bad connection between the terminal and the platform.	Check the cable for damage (kinked, twisted or broken pins).	Replace the terminal cable.
	A device error has occurred.	Check if a device error is listed in the service menu, see [Service menu ▶ Page 124]. Tap <b>Device errors</b> .	Note the error code and contact your METTLER TOLEDO service representative.
<b>Cannot start adjustment</b>	Initial zero was not reached when the balance was switched on.	–	Disconnect the power cable and reconnect after a few seconds.
<b>Preventive performance optimization</b>	The balance memory (RAM) is full.	–	Complete the current task. Disconnect the power cable and reconnect after a few seconds.
<b>HeightDetect error No vessel could be detected.</b>	The sample vessel opening is too low.	–	Use a different ErgoClip, see the Reference Manual of the Q3 dosing module.
	The sample vessel is not in the center of the weighing pan.	–	Position the sample vessel in the center of the weighing pan.
	Reflections from the sample vessel surface prevent the optical sensor to detect the vial.	–	Try a different sample vessel (other size, geometry, surface, material, or color).  Disable <b>HeightDetect</b> and set the dosing position manually, see [Absolute Dosing position ▶ Page 98].

Error message	Possible cause	Diagnostic	Remedy
<b>Dosing head coupling error</b>	The dosing module (rotation pin) cannot mechanically couple with the dosing head because dirt on the dosing head.	–	Clean the coupling area of the dosing head.
	The dosing module (rotation pin) cannot mechanically couple with the dosing head because the rotation pin is deformed.	–	Contact your METTLER TOLEDO service representative.
<b>Dosing head blocked</b>	The powder in the dosing head formed clogs and prevents the dosing pin from moving.	Remove the dosing head and try to rotate or push the dosing pin using a T6 Torx screwdriver.  <b>i Note</b> When pushing the dosing pin, powder might come out of the dosing head.	Turn the dosing head upside down and shake it to loosen the powder.  To avoid compacting the powder in the dosing head, turn off the tapper. See [Managing the dosing head data ▶ Page 99].  If dosing head is still blocked, replace it.
<b>Powder dosing stopped</b>	The powder does not flow freely towards the dispensing mechanism of the dosing head.	–	Turn the dosing head upside down and shake it to loosen the powder.  To increase the flow of powder, turn on the tapper. See [Managing the dosing head data ▶ Page 99].
<b>Liquid dosing stopped</b>	The flow of liquid in the dosing head is too low.	There is not enough liquid in the bottle.	Fill the bottle.
	The liquid dosing head is partially or fully blocked.	–	Clean the micro dosing valve of the QH001 or QH002 dosing head. Replace the dosing head.
	The environment is unstable.	–	Provide a stable weighing environment.
<b>RFID tag error</b>	The dosing head is not properly attached to the dosing module.	Check if the dosing head is properly attached.	Attach the dosing head properly.
	The RFID tag is dirty.	Check for impurities.	Clean and try again.
	The dosing head data is corrupted.	Try to access the dosing head data. See [Managing the dosing head data ▶ Page 99].  If the data cannot be accessed, the dosing head is defective.	Replace the dosing head.
	The dosing head is defective.	Check with another dosing head.	Replace the dosing head.



**See also**

 Service menu ▶ Page 124

## 8.2 Error symptoms

Error symptom	Possible cause	Diagnostic	Remedy
The display is dark.	The instrument is on standby.	–	Switch on the instrument.
	There is no power.	Check the connection to the AC/DC adapter and the power outlet.	Connect the platform to the power outlet. See "Connecting the balance".
	The terminal is not connected to the instrument.	Check the terminal cable connection.	Connect the terminal cable to the instrument.
	The terminal cable is defective.	Check the cable for damage (kinked, twisted or broken pins).	Replace the terminal cable.
	The wrong AC/DC adapter is connected to the instrument.	Check it, see "Technical Data".	Use the correct AC/DC adapter.
	The AC/DC adapter is defective.	–	Replace the AC/DC adapter.
The value on the display oscillates.	Vibrations on the weighing bench, e.g., building vibrations, foot traffic	Place a beaker with water on the weighing bench. Vibrations cause ripples on the water surface.	Protect the weighing location against vibrations, e.g. with an absorber. Find a different weighing location.
	Draft due to untight draft shield and/or open window.	Check the draft shield for gaps.	Fix the draft shield. Close the window.
	The weighing sample is electrostatically charged.	Check if the weighing result is stable when using a test weight.	Increase the air humidity in the weighing chamber. Use an ionizer. See "Accessories".
	The location is not suitable for weighing.	–	Follow the requirements for the location. See "Selecting the location".
	Something is touching the weighing pan.	Check for touching parts or dirt.	Remove touching parts. Clean the balance.
The value on the display is drifting towards plus or minus.	The weighing sample absorbs moisture or evaporates moisture.	Check if the weighing result is stable when using a test weight.	Cover the weighing sample.
	The weighing sample is electrostatically charged.	Check if the weighing result is stable when using a test weight.	Increase the air humidity in the weighing chamber. Use an ionizer. See "Accessories".
	The weighing sample is warmer or colder than the air in the weighing chamber.	Check if the weighing result is stable when using an acclimatized test weight.	Bring the sample to room temperature.

Error symptom	Possible cause	Diagnostic	Remedy
	The balance has not yet warmed up.	–	Let the balance warm up. Adequate warm-up time is specified in the "General data".
The display shows overload or underload.	The wrong weighing pan is installed.	Slightly lift or press the weighing pan to see if the weight appears on the display.	Install the proper weighing pan.
	No weighing pan is installed.	–	Install the proper weighing pan.
	Incorrect zero point at power on.	–	Disconnect the power cable and reconnect after a few seconds.
	The balance is not adjusted.	–	Perform an internal adjustment. See "Internal adjustment".
The front panel of the draft shield is not at a 90° angle to the platform.	The draft shield front panel is not perfectly adjusted.	–	Contact your METTLER TOLEDO service representative to adjust the front panel.
The draft shield side doors are not fully closed.	The draft shield side doors are not perfectly adjusted.	–	Contact your METTLER TOLEDO service representative to adjust the side doors.
The user interface responds slowly.	Too many results are included in the <b>Results list</b> of a task.	Check the <b>Results list</b> of every running and pending task.	Complete all tasks: For each task in the list of <b>Tasks</b> , select the task, tap <b>Continue task</b> , and tap <b>Complete</b> .

### 8.3 Putting into operation after fixing an error

After troubleshooting, perform the following steps to put the balance into operation:

- Ensure that the balance is completely reassembled and cleaned.
- Reconnect the balance to the AC/DC adapter.

## 9 Technical Data

### 9.1 General data

#### Power supply

AC/DC adapter (model no. FSP060-DHAN3):	Input: 100 – 240 V AC $\pm$ 10%, 50 – 60 Hz, 1.8 A Output: 12 V DC, 5 A, LPS, SELV
AC/DC adapter (model no. FSP060-DIBAN2):	Input: 100 – 240 V AC $\pm$ 10%, 50 – 60 Hz, 1.5 A Output: 12 V DC, 5 A, LPS, SELV
Cable for AC/DC adapter:	3-core, with country-specific plug
Balance power consumption:	12 V DC $\pm$ 10%, 2.25 A
Polarity:	

#### Protection and standards

Overvoltage category:	II
Degree of pollution:	2
Standards for safety and EMC:	See Declaration of Conformity
Range of application:	Use only indoors in dry locations

#### Environmental conditions

The limit values apply when the balance is used under the following environmental conditions:

Height above mean sea level:	Up to 5000 m
Ambient temperature:	+10 – +30 °C
Temperature change, max.:	5 °C/h
Relative humidity:	30 – 70%, non-condensing
Acclimatization time:	At least <b>8 hours</b> after placing the instrument in the same location where it will be put into operation.
Warm-up time:	At least <b>120 minutes</b> after connecting the balance to the power supply. When switched on from standby, the instrument is ready for operation immediately.

The balance can be used under the following environmental conditions. However, the weighing performances of the balance may be outside the limit values:

Ambient temperature:	+5 °C – +40 °C
Relative humidity:	20% to max. 80% at 31 °C, decreasing linearly to 50% at 40 °C, non-condensing

The balance can be disconnected and stored in its packaging under the following conditions:

Ambient temperature:	-25 – +70 °C
Relative humidity:	10 – 90%, non-condensing

#### Environmental conditions for comparators

Comparators need to be used under the following environmental conditions to reach the specified performances:

Air speed, max.:	0.15 m/s
------------------	----------

## 9.2 Explanatory notes for the METTLER TOLEDO AC/DC adapter

The certified external AC/DC adapter complies to the requirements for Class II double insulated equipment. It is not provided with a protective earth connection but with a functional earth connection for EMC purposes. This earth connection **is not** a safety feature. Further information about the compliance of our products can be found in the "Declaration of Conformity" delivered with every product.

In case of testing with regard to the European Directive 2001/95/EC, the AC/DC adapter and the instrument have to be handled as Class II double insulated equipment.

Consequently, a grounding test is not required. It is not necessary to carry out a grounding test between the earth connector of the power plug and any exposed part of the metallic housing of the instrument.

Because the instrument is sensitive to static charges, a leakage resistor of 10 k $\Omega$  is connected between the earth connector (1) and the negative pole (2) of the AC/DC adapter. The arrangement is shown in the equivalent circuit diagram. This resistor is not part of the electrical safety arrangement and does not require testing at regular intervals.

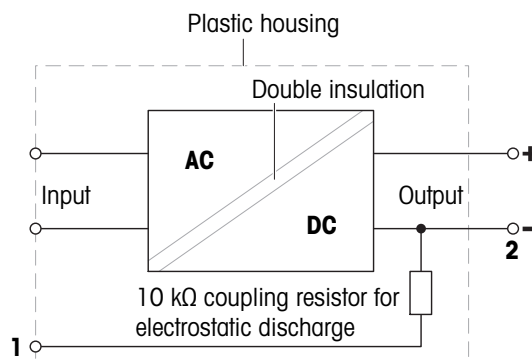

## 9.3 Model-specific data

### 9.3.1 XPR analytical balances

	XPR106DUH	XPR226DR	XPR226CDR
<b>Limit values</b>			
Capacity	120 g	220 g	220 g
Nominal load	100 g	200 g	200 g
Readability	0.005 mg	0.01 mg	0.01 mg
Capacity of fine range	41 g	121 g	121 g
Readability in fine range	0.002 mg	0.005 mg	0.005 mg
Repeatability (at nominal load)	0.02 mg	0.025 mg	0.025 mg
Repeatability (at 5% load)	0.005 mg	0.01 mg	0.01 mg
Repeatability, automated (at 5% load) ≡	0.003 mg	0.005 mg	0.0045 mg
Repeatability ABA (5 cycles at nominal load)	–	–	0.02 mg
Repeatability ABA (5 cycles at 5% load)	–	–	0.005 mg
Linearity deviation	0.1 mg	0.1 mg	0.1 mg
Eccentricity deviation (at test load)	0.12 mg (50 g)	0.2 mg (100 g)	0.2 mg (100 g)
Sensitivity offset (at nominal load) ▲	0.3 mg	0.4 mg	0.4 mg
Sensitivity temperature drift	0.0001%/°C	0.0001%/°C	0.0001%/°C
<b>Typical values</b>			
Repeatability (at 5% load)	0.003 mg	0.004 mg	0.004 mg
Repeatability, automated (at 5% load) ≡	0.002 mg	0.0035 mg	0.003 mg
Repeatability ABA (5 cycles at nominal load)	–	–	0.012 mg
Repeatability ABA (5 cycles at 5% load)	–	–	0.003 mg
Linearity deviation	0.03 mg	0.03 mg	0.03 mg
Eccentricity deviation (at test load)	0.04 mg (50 g)	0.06 mg (100 g)	0.06 mg (100 g)
Sensitivity offset (at nominal load) ▲	0.15 mg	0.25 mg	0.25 mg
Minimum weight (USP, tolerance = 0.10%) ▼	6 mg	8 mg	8 mg
Minimum weight (tolerance = 1%) ▼	0.6 mg	0.8 mg	0.8 mg
Minimum weight automated (USP, tolerance = 0.10%) ▼	4 mg	6 mg	6 mg
Minimum weight automated (tolerance = 1%) ▼	0.4 mg	0.6 mg	0.6 mg
Settling time	2.5 s	2 s	5 s
<b>Dimensions and other specifications</b>			
Balance dimensions (W × D × H)	195 × 485 × 215 mm	195 × 485 × 292 mm	195 × 485 × 292 mm
Weighing pan dimensions (W × D)	64 × 56 mm	78 × 73 mm	78 × 73 mm
Usable height of draft shield	159 mm	235 mm	235 mm
Balance weight	9 kg	9.4 kg	9.4 kg
<b>Weights for routine testing</b>			
Weights (OIML class)	100 g (F2) / 5 g (F2)	200 g (F2) / 10 g (F2)	200 g (F2) / 10 g (F2)
Weights (ASTM class)	100 g (ASTM 1) / 5 g (ASTM 1)	200 g (ASTM 1) / 10 g (ASTM 1)	200 g (ASTM 1) / 10 g (ASTM 1)

≡ with closed doors

▲ after adjustment with internal weight

▼ determined at 5% load, k = 2

	XPR105	XPR205
<b>Limit values</b>		
Capacity	120 g	220 g
Nominal load	100 g	200 g
Readability	0.01 mg	0.01 mg
Capacity of fine range	–	–
Readability in fine range	–	–
Repeatability (at nominal load)	0.03 mg	0.03 mg
Repeatability (at 5% load)	0.015 mg	0.015 mg
Repeatability, automated (at 5% load) ≡	0.007 mg	0.007 mg
Repeatability ABA (5 cycles at nominal load)	–	–
Repeatability ABA (5 cycles at 5% load)	–	–
Linearity deviation	0.1 mg	0.1 mg
Eccentricity deviation (at test load)	0.12 mg (50 g)	0.2 mg (100 g)
Sensitivity offset (at nominal load) ▲	0.3 mg	0.4 mg
Sensitivity temperature drift	0.0001%/°C	0.0001%/°C
<b>Typical values</b>		
Repeatability (at 5% load)	0.007 mg	0.007 mg
Repeatability, automated (at 5% load) ≡	0.005 mg	0.005 mg
Repeatability ABA (5 cycles at nominal load)	–	–
Repeatability ABA (5 cycles at 5% load)	–	–
Linearity deviation	0.03 mg	0.03 mg
Eccentricity deviation (at test load)	0.04 mg (50 g)	0.06 mg (100 g)
Sensitivity offset (at nominal load) ▲	0.15 mg	0.25 mg
Minimum weight (USP, tolerance = 0.10%) ▼	14 mg	14 mg
Minimum weight (tolerance = 1%) ▼	1.4 mg	1.4 mg
Minimum weight automated (USP, tolerance = 0.10%) ▼	10 mg	10 mg
Minimum weight automated (tolerance = 1%) ▼	1 mg	1 mg
Settling time	2 s	2 s
<b>Dimensions and other specifications</b>		
Balance dimensions (W × D × H)	195 × 485 × 292 mm	195 × 485 × 292 mm
Weighing pan dimensions (W × D)	78 × 73 mm	78 × 73 mm
Usable height of draft shield	235 mm	235 mm
Balance weight	9.4 kg	9.4 kg
<b>Weights for routine testing</b>		
Weights (OIML class)	100 g (F2) / 5 g (F2)	200 g (F2) / 10 g (F2)
Weights (ASTM class)	100 g (ASTM 1) / 5 g (ASTM 1)	200 g (ASTM 1) / 10 g (ASTM 1)

≡ with closed doors

▲ after adjustment with internal weight

▼ determined at 5% load, k = 2

<b>Limit values</b>	
Capacity	220 g
Nominal load	200 g
Readability	0.1 mg
Capacity of fine range	121 g
Readability in fine range	0.01 mg
Repeatability (at nominal load)	0.06 mg
Repeatability, automated (at 5% load) ≡	0.007 mg
Repeatability (at 5% load)	0.015 mg
Repeatability ABA (5 cycles at nominal load)	–
Repeatability ABA (5 cycles at 5% load)	–
Linearity deviation	0.15 mg
Eccentricity deviation (at test load)	0.25 mg (100 g)
Sensitivity offset (at nominal load) ▲	0.5 mg
Sensitivity temperature drift	0.0001%/°C
<b>Typical values</b>	
Repeatability (at 5% load)	0.007 mg
Repeatability, automated (at 5% load) ≡	0.005 mg
Repeatability ABA (5 cycles at nominal load)	–
Repeatability ABA (5 cycles at 5% load)	–
Linearity deviation	0.03 mg
Eccentricity deviation (at test load)	0.08 mg (100 g)
Sensitivity offset (at nominal load) ▲	0.3 mg
Minimum weight (USP, tolerance = 0.10%) ▼	14 mg
Minimum weight (tolerance = 1%) ▼	1.4 mg
Minimum weight automated (USP, tolerance = 0.10%) ▼	10 mg
Minimum weight automated (tolerance = 1%) ▼	1 mg
Settling time	1.5 s
<b>Dimensions and other specifications</b>	
Balance dimensions (W × D × H)	195 × 485 × 292 mm
Weighing pan dimensions (W × D)	78 × 73 mm
Usable height of draft shield	235 mm
Balance weight	9.4 kg
<b>Weights for routine testing</b>	
Weights (OIML class)	200 g (F2) / 10 g (F2)
Weights (ASTM class)	200 g (ASTM 1) / 10 g (ASTM 1)

≡ with closed doors

▲ after adjustment with internal weight

▼ determined at 5% load, k = 2

	XPR305DR	XPR204
<b>Limit values</b>		
Capacity	320 g	220 g
Nominal load	300 g	200 g
Readability	0.1 mg	0.1 mg
Capacity of fine range	121 g	–
Readability in fine range	0.01 mg	–
Repeatability (at nominal load)	0.08 mg	0.07 mg
Repeatability, automated (at 5% load) ≡	0.04 mg	0.045 mg
Repeatability (at 5% load)	0.06 mg	0.05 mg
Repeatability ABA (5 cycles at nominal load)	–	–
Repeatability ABA (5 cycles at 5% load)	–	–
Linearity deviation	0.3 mg	0.2 mg
Eccentricity deviation (at test load)	0.25 mg (100 g)	0.3 mg (100 g)
Sensitivity offset (at nominal load) ▲	1 mg	0.6 mg
Sensitivity temperature drift	0.0001%/°C	0.0001%/°C
<b>Typical values</b>		
Repeatability (at 5% load)	0.02 mg	0.04 mg
Repeatability, automated (at 5% load) ≡	0.015 mg	0.04 mg
Repeatability ABA (5 cycles at nominal load)	–	–
Repeatability ABA (5 cycles at 5% load)	–	–
Linearity deviation	0.1 mg	0.06 mg
Eccentricity deviation (at test load)	0.08 mg (100 g)	0.1 mg (100 g)
Sensitivity offset (at nominal load) ▲	0.6 mg	0.4 mg
Minimum weight (USP, tolerance = 0.10%) ▼	40 mg	82 mg
Minimum weight (tolerance = 1%) ▼	4 mg	8.2 mg
Minimum weight automated (USP, tolerance = 0.10%) ▼	41 mg	82 mg
Minimum weight automated (tolerance = 1%) ▼	4.1 mg	8.2 mg
Settling time	1.5 s	1.5 s
<b>Dimensions and other specifications</b>		
Balance dimensions (W × D × H)	195 × 485 × 292 mm	195 × 485 × 292 mm
Weighing pan dimensions (W × D)	78 × 73 mm	78 × 73 mm
Usable height of draft shield	235 mm	235 mm
Balance weight	9.4 kg	9.4 kg
<b>Weights for routine testing</b>		
Weights (OIML class)	200 g (F2) / 10 g (F2)	200 g (F2) / 10 g (F2)
Weights (ASTM class)	200 g (ASTM 1) / 10 g (ASTM 1)	200 g (ASTM 1) / 10 g (ASTM 1)

≡ with closed doors

▲ after adjustment with internal weight

▼ determined at 5% load, k = 2



### 9.3.2 XPR analytical balances in use with MCP-R pipette calibration module

	XPR106DUHR	XPR105DUHR
<b>Limit values</b>		
Capacity	120 g	120 g
Nominal load	100 g	100 g
Readability	0.005 mg	0.1 mg
Capacity of fine range	41 g	41 g
Readability in fine range	0.002 mg	0.01 mg
Repeatability (at nominal load)	0.02 mg	0.1 mg
Repeatability (at 5% load)	0.005 mg	0.02 mg
Repeatability, automated (at 5% load) ≡	–	–
Repeatability ABA (5 cycles at nominal load)	–	–
Repeatability ABA (5 cycles at 5% load)	–	–
Linearity deviation	0.1 mg	0.2 mg
Eccentricity deviation (at test load)	0.12 mg (50 g)	0.3 mg (50 g)
Sensitivity offset (at nominal load) ▲	0.3 mg	0.5 mg
Sensitivity temperature drift	0.0001%/°C	0.00015%/°C
<b>Typical values</b>		
Repeatability (at 5% load)	0.003 mg	0.01 mg
Repeatability, automated (at 5% load) ≡	–	–
Repeatability ABA (5 cycles at nominal load)	–	–
Repeatability ABA (5 cycles at 5% load)	–	–
Linearity deviation	0.03 mg	0.06 mg
Eccentricity deviation (at test load)	0.04 mg (50 g)	0.1 mg (50 g)
Sensitivity offset (at nominal load) ▲	0.15 mg	0.3 mg
Minimum weight (USP, tolerance = 0.10%) ▼	6 mg	20 mg
Minimum weight (tolerance = 1%) ▼	0.6 mg	2 mg
Minimum weight automated (USP, tolerance = 0.10%) ▼	–	–
Minimum weight automated (tolerance = 1%) ▼	–	–
Settling time	4.3 s	4 s
<b>Dimensions and other specifications</b>		
Balance dimensions (W × D × H)	195 × 485 × 215 mm	195 × 456 × 292 mm
Weighing pan dimensions (W × D)	64 × 56 mm	78 × 73 mm
Usable height of draft shield	159 mm	235 mm
Balance weight	9 kg	8.6 kg
<b>Weights for routine testing</b>		
Weights (OIML class)	100 g (F2) / 5 g (F2)	100 g (F2) / 5 g (F2)
Weights (ASTM class)	100 g (ASTM 1) / 5 g (ASTM 1)	100 g (ASTM 1) / 5 g (ASTM 1)

≡ with closed doors

▲ after adjustment with internal weight

▼ determined at 5% load, k = 2

## 9.4 Dimensions

### 9.4.1 XPR analytical balances, full-height draft shield

**Models:** XPR225DU, XPR226DR, XPR226CDR, XPR105, XPR205, XPR305DR, XPR204

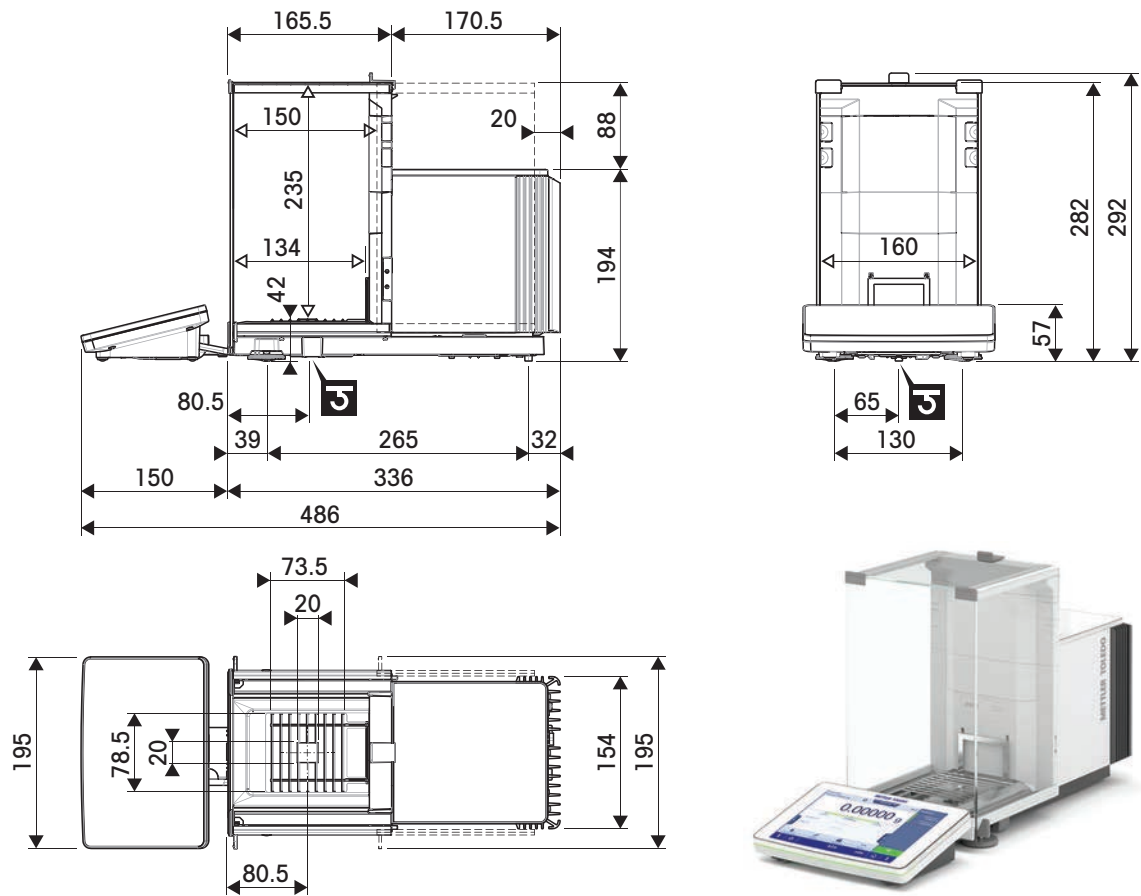

	Outer dimensions [mm]
	Clear dimensions [mm]
	Position of the weighing hook axle

## 9.4.2 XPR analytical balances, half-height draft shield

### 9.4.2.1 Readability 0.002 mg

Models: XPR106DUH, XPR106DUHR

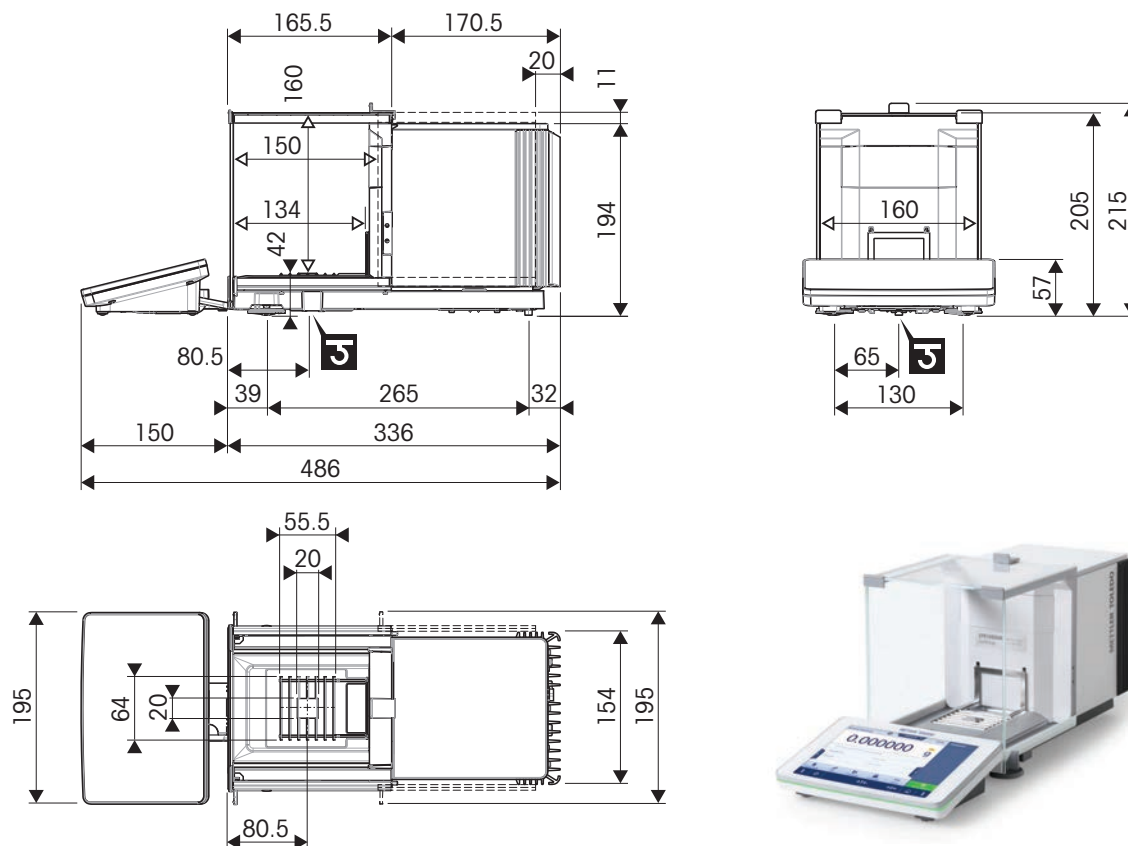

	Outer dimensions [mm]
	Clear dimensions [mm]
	Position of the weighing hook axle

### 9.4.2.2 Readability 0.01 mg

Models: XPR105DUHR

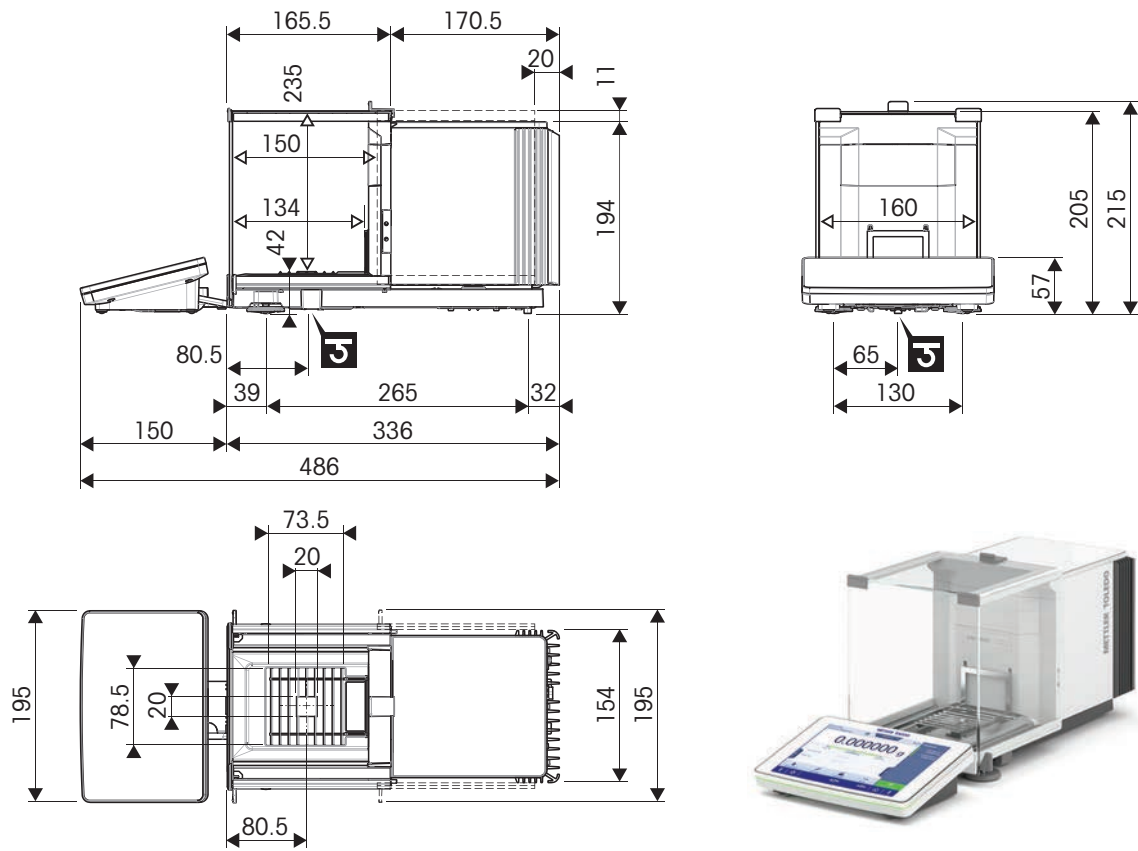

	Outer dimensions [mm]
	Clear dimensions [mm]
	Position of the weighing hook axle

## 10 Disposal

In conformance with the European Directive 2012/19/EU on Waste Electrical and Electronic Equipment (WEEE), this equipment may not be disposed of in domestic waste. This also applies to countries outside the EU, per their specific requirements.

Please dispose of this equipment in accordance with local regulations at the collecting point specified for electrical and electronic equipment. If you have any questions, please contact the responsible authority or the distributor from which you purchased this equipment. Should this equipment be passed on to other parties, the content of this directive must also be passed on to the other party.



## 11 Accessories and Spare Parts

### 11.1 Accessories

Accessories are additional components that could help you in your workflow.

Some accessories are not compatible with all balances. For more information about accessory compatibility, please contact your METTLER TOLEDO sales representative.

#### 11.1.1 XPR analytical balance, full-height draft shield

	Description	Order no.
<b>Weighing pans</b>		
	SmartGrid cover	11106709
	Single-use aluminium weighing pans, 10 units	11106711
<b>ErgoClips</b>		
	ErgoClip filter holder	30460844
	ErgoClip flask, small	30460854
	ErgoClip syringe	30460859
	ErgoClip tube	30460853



ErgoClip Stand

11140170



ErgoClip Titration Basket

11106883

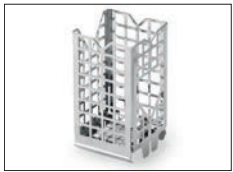

ErgoClip Basket

11106747

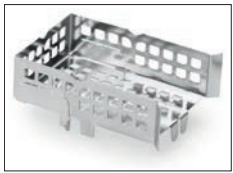

ErgoClip Weighing Boat

11106748



ErgoClip Round-Bottom Flask

11106746

### Pipette calibration



SmartTrap beaker 50 ml, > 20 - 2000 µl

30215436



Evaporation trap 100 ml

30460847

### Dosing components



Q3 dosing module

30418661

Must be installed by a METTLER TOLEDO service technician.



QLX3 liquid module

Must be installed by a METTLER TOLEDO service technician.

30418658



QL3 pump

30418660



QLL standard kit for bottles

- QL001 liquid dosing head
- 250 ml bottle, pressure resistant
- Bottle cap (GL45) with tube connector and dosing head support
- Spare parts for QLL standard kit

30008318



QLL standard kit for small bottles

- QL001 liquid dosing head
- 25 ml bottle, pressure resistant
- Stand for bottle
- Bottle cap (GL25) with tube connector
- Spare parts for QLL standard kit small

30237340



QLL advanced kit for bottles

- QL003 liquid dosing head
- 250 ml bottle, pressure resistant
- Bottle cap (GL45) with tube connector and dosing head support
- Spare parts for QLL standard kit

30521817



QS3 sample changer

Must be installed by a METTLER TOLEDO service technician.

30418662

### Antistatic kits



Ionizer module

30460823



Compact ionizer (USB) with mounting adapter

30499860



	Compact ionizer with stand (USB)	30499859
	Additional compact ionizer (USB) for Compact ionizer with stand (30499859)	30496446
	Integrable antistatic kit standard Including one pair of multiple-point electrodes and power supply. Must be installed by a METTLER TOLEDO service technician.	30521821

**Filling-process control**



	LV12 automatic feeder	30374389
	Door left draft shield LV1x	30460841
	Door right draft shield LV1x	30460840

**Filter kits**





	Filter kit	30460857
--	------------	----------

**Density determination**

	Density kit	30460852
--	-------------	----------

	Sinker 10 mL	210260
	Calibrated Sinker 10mL	210672
	Calibrated Thermometer	11132685

### Printers

	<p>CLS-631 label printer (RS232C/USB-A)</p> <p>Label and ink ribbon kit</p> <p>The NetCom Kit might be needed for this printer. Contact your local METTLER TOLEDO service representative.</p>	<p>11141820</p> <p>30004309</p>
	<p>P-52RUE dot matrix printer RS232C, USB and Ethernet connections, simple print-outs</p> <p>Paper roll (length: 20 m), set of 5 pcs</p> <p>Paper roll (length: 13 m), self-adhesive, set of 3 pcs</p> <p>Ribbon cartridge, black, set of 2 pcs</p>	<p>30237290</p> <p>00072456</p> <p>11600388</p> <p>00065975</p>
	<p>P-56RUE thermal printer with RS232C, USB and Ethernet connections, simple print-outs, date and time</p> <p>Paper roll, white (length: 27 m), set of 10 pcs</p> <p>Paper roll, white, self-adhesive (length: 13 m), set of 10 pcs</p>	<p>30094673</p> <p>30094723</p> <p>30094724</p>
	<p>P-58RUE thermal printer with RS232C, USB and Ethernet connections, simple print-outs, date and time, label printing, balance applications, e.g., statistics, formulation, totaling</p> <p>Paper roll, white (length: 27 m), set of 10 pcs</p> <p>Paper roll, white, self-adhesive (length: 13 m), set of 10 pcs</p> <p>Paper roll, white, self-adhesive labels (550 labels), set of 6 pcs</p> <p>Dimension of the label 56×18 mm</p>	<p>30094674</p> <p>30094723</p> <p>30094724</p> <p>30094725</p>

### Anti-theft devices



Anti-theft cable with lock

11600361

### RFID readers / writers / cards



EasyScan USB  
Reads and writes RFID tags.

30416173



SmartScan  
Must be installed by a METTLER TOLEDO service technician.

30459915



Smart Tag  
Set of 50 pieces  
Set of 200 pieces

30101517

30101518

### Hands-free accessories

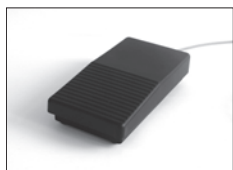

Foot switch, optional switch for remote operation (USB connection)

30312558



ErgoSens, optical sensor for remote operation (USB connection)

30300915

### Barcode readers



Corded USB barcode reader

30417466

### Cables for RS232C interfaces



USB-RS232C cable (to connect the instrument via RS232C to a USB port)

64088427

### Wireless interfaces



Bluetooth RS232C serial adapter ADP-BT-S

30086494

For wireless connection between:

- instrument and computer (depending on the instrument model)
- printer and instrument



Bluetooth USB adapter for wireless connection to P-5x printer (additional Bluetooth RS232C serial adapter 30086494 required)

30416089

### Weighing tables



Weighing table

11138042

### Software



LabX Balance Express

11153120

Stand-alone system, includes one balance license.



LabX Balance Server

11153121

Client server system, includes one balance license.



LabX 1 Balance instrument license

11153220

Single additional instrument license for Express or Server edition.



SQC license

30539260

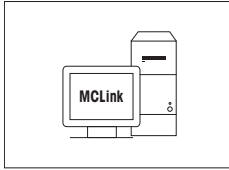

### MC Link mass calibration software

MC Link license – 1 Instrument	30208285
MC Link Upgrade Multi Place	30208289
MC Link Option – Barcode Package	30212767
MC Link Option – Audit Trail	30208283
MC Link Validation Handbook	30212634
MC Link Remote Installation Service	30212635

### Adjustment weights



OIML / ASTM Weights (with calibration certificate)  
▶ [www.mf.com/weights](http://www.mf.com/weights)

### Various



EasyHub USB

30468768



SmartPrep, single-use funnel for quick and easy sample preparation. For flask sizes 10/19, 12/21, 14/23. 50 pcs

30061260

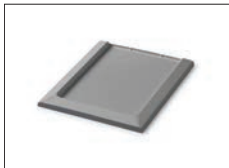

Drip tray, gray







30460856









Terminal cable, extended, length: 4.5 m



30300920

## 11.1.2 XPR analytical balance, half-height draft shield

	Description	Order no.
<b>ErgoClips</b>		
	ErgoClip vial	30521808
<b>Antistatic kits</b>		
	Ionizer module	30460823
	Compact ionizer (USB) with mounting adapter	30499860
	Compact ionizer with stand (USB)	30499859
	Additional compact ionizer (USB) for Compact ionizer with stand (30499859)	30496446
	Integrable antistatic kit small Including one pair of multiple-point electrodes and power supply. Must be installed by a METTLER TOLEDO service technician.	30521822
<b>Dosing components</b>		
	Q3 dosing module Must be installed by a METTLER TOLEDO service technician.	30418661

	Q3 module mounting kit	30521816
	QL3 pump	30418660
	<p>QLL standard kit for bottles</p> <ul style="list-style-type: none"> <li>• QL001 liquid dosing head</li> <li>• 250 ml bottle, pressure resistant</li> <li>• Bottle cap (GL45) with tube connector and dosing head support</li> <li>• Spare parts for QLL standard kit</li> </ul>	30008318
	<p>QLL standard kit for small bottles</p> <ul style="list-style-type: none"> <li>• QL001 liquid dosing head</li> <li>• 25 ml bottle, pressure resistant</li> <li>• Stand for bottle</li> <li>• Bottle cap (GL25) with tube connector</li> <li>• Spare parts for QLL standard kit small</li> </ul>	30237340
	<p>QLL advanced kit for bottles</p> <ul style="list-style-type: none"> <li>• QL003 liquid dosing head</li> <li>• 250 ml bottle, pressure resistant</li> <li>• Bottle cap (GL45) with tube connector and dosing head support</li> <li>• Spare parts for QLL standard kit</li> </ul>	30521817
	<p>QS3 sample changer</p> <p>Must be installed by a METTLER TOLEDO service technician.</p>	30418662

## Printers

	P-52RUE dot matrix printer RS232C, USB and Ethernet connections, simple print-outs	30237290
	Paper roll (length: 20 m), set of 5 pcs	00072456
	Paper roll (length: 13 m), self-adhesive, set of 3 pcs	11600388
	Ribbon cartridge, black, set of 2 pcs	00065975
	P-56RUE thermal printer with RS232C, USB and Ethernet connections, simple print-outs, date and time	30094673
	Paper roll, white (length: 27 m), set of 10 pcs	30094723
	Paper roll, white, self-adhesive (length: 13 m), set of 10 pcs	30094724



P-58RUE thermal printer with RS232C, USB and Ethernet connections, simple print-outs, date and time, label printing, balance applications, e.g., statistics, formulation, totaling

30094674

Paper roll, white (length: 27 m), set of 10 pcs

30094723

Paper roll, white, self-adhesive (length: 13 m), set of 10 pcs

30094724

Paper roll, white, self-adhesive labels (550 labels), set of 6 pcs

30094725

Dimension of the label 56×18 mm

### Anti-theft devices



Anti-theft cable with lock

11600361

### RFID readers / writers / cards



EasyScan USB  
Reads and writes RFID tags.

30416173



Smart Tag

Set of 50 pieces

30101517

Set of 200 pieces

30101518

### Hands-free accessories

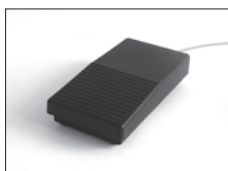

Foot switch, optional switch for remote operation (USB connection)

30312558



ErgoSens, optical sensor for remote operation (USB connection)

30300915

### Barcode readers



Corded USB barcode reader

30417466



### Cables for RS232C interfaces



USB-RS232 cable (to connect the instrument via RS232C to a USB port)

64088427

### Wireless interfaces



Bluetooth RS232C serial adapter ADP-BT-S

30086494

For wireless connection between:

- instrument and computer (depending on the instrument model)
- printer and instrument



Bluetooth USB adapter for wireless connection to P-5x printer (additional Bluetooth RS232 serial adapter 30086494 required)

30416089

### Weighing tables



Weighing table

11138042

### Software



LabX Balance Express

11153120

Stand-alone system, includes one balance license.



LabX Balance Server

11153121

Client server system, includes one balance license.



LabX 1 Balance instrument license

11153220

Single additional instrument license for Express or Server edition.



SQC license

30539260

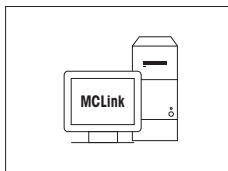

### MC Link mass calibration software

MC Link license – 1 Instrument	30208285
MC Link Upgrade Multi Place	30208289
MC Link Option – Barcode Package	30212767
MC Link Option – Audit Trail	30208283
MC Link Validation Handbook	30212634
MC Link Remote Installation Service	30212635

### Adjustment weights



OIML / ASTM Weights (with calibration certificate)  
▶ [www.mt.com/weights](http://www.mt.com/weights)

### Various



EasyHub USB

30468768



SmartPrep, single-use funnel for quick and easy sample preparation. For flask sizes 10/19, 12/21, 14/23. 50 pcs

30061260



Terminal cable, extended, length: 4.5 m

30300920

## 11.2 Spare parts

Spare parts are parts that are delivered with the original instrument but that can be replaced, if needed, without the help of a service technician.

### 11.2.1 Weighing chamber, full-height draft shield

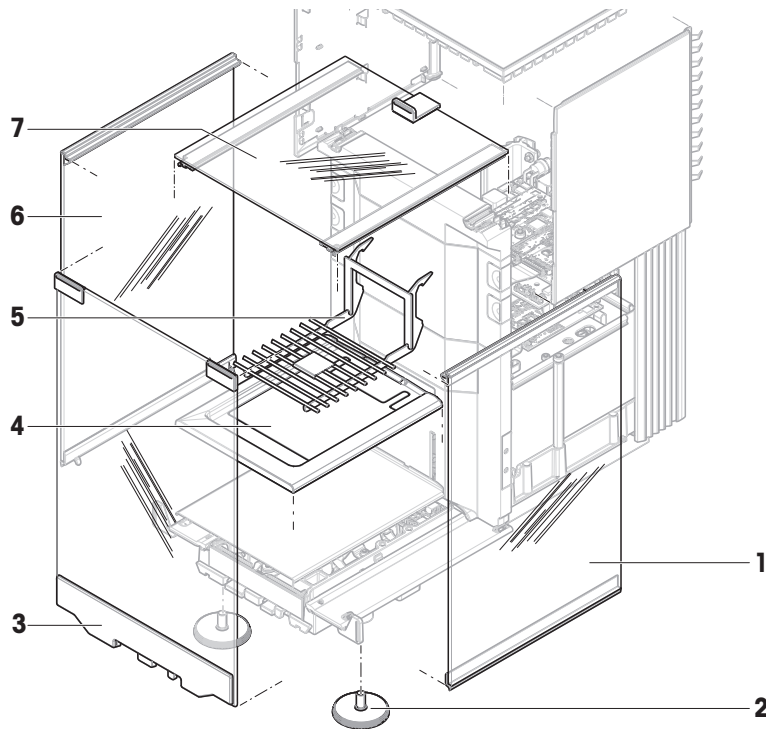

	Order no.	Designation	Remarks
1	30459875	Door right high draft shield	–
2	30460287	Leveling feet, set	Including: 2 leveling feet
3	30459877	Panel front high draft shield	–
4	30460281	Drip tray StaticDetect	–
5	30460285	Weighing pan SmartGrid XPR XSR	–
6	30459874	Door left high draft shield	–
7	30459876	Door top draft shield	–

## 11.2.2 Weighing chamber, half-height draft shield

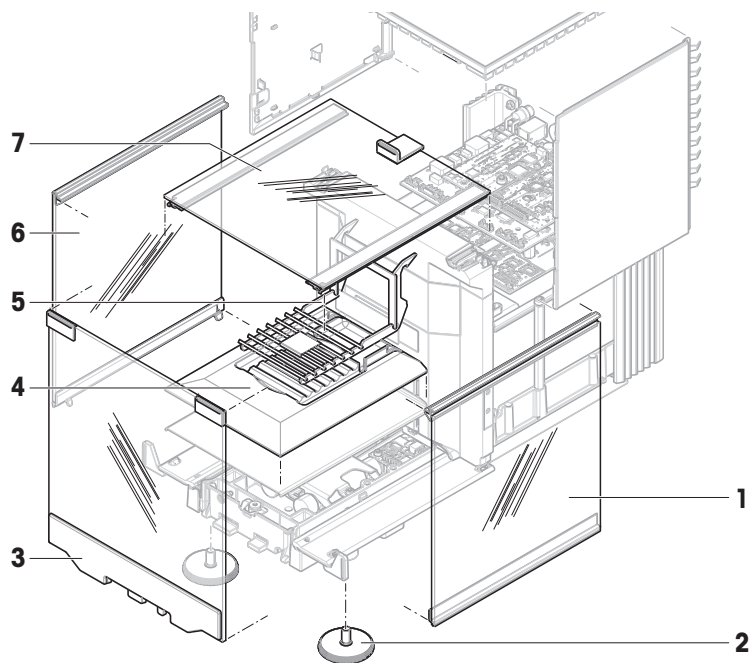

	Order no.	Designation	Remarks
<b>1</b>	30459909	Door right low draft shield	—
<b>2</b>	30460287	Leveling feet, set	Including: 2 leveling feet
<b>3</b>	30459910	Panel front low draft shield	—
<b>4</b>	30542016	Drip tray StaticDetect XPR106	—
<b>5</b>	30460284	Weighing pan SmartGrid XPR	—
<b>6</b>	30459908	Door left low draft shield	—
<b>7</b>	30459876	Door top draft shield	—

### 11.2.3 Miscellaneous

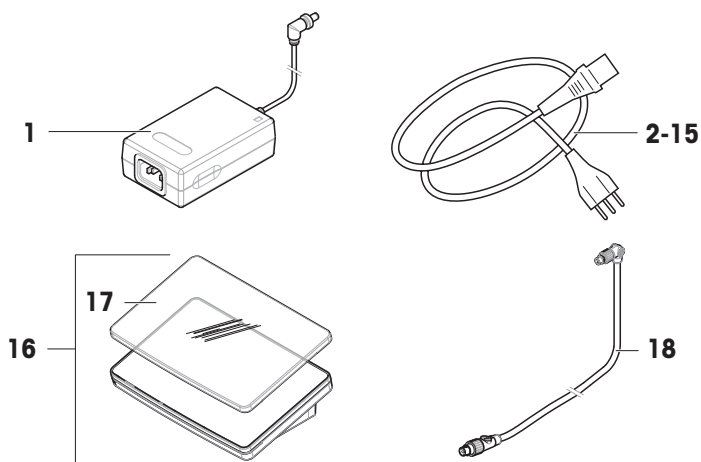

	Order no.	Designation	Remarks
<b>1</b>	30388323	AC/DC adapter	Output: 12 V DC, 5 A
<b>2</b>	88751	Power cable AU	–
<b>3</b>	30015268	Power cable BR	–
<b>4</b>	87920	Power cable CH	–
<b>5</b>	30047293	Power cable CN	–
<b>6</b>	87452	Power cable DK	–
<b>7</b>	87925	Power cable EU	–
<b>8</b>	89405	Power cable GB	–
<b>9</b>	225297	Power cable IL	–
<b>10</b>	11600569	Power cable IN	–
<b>11</b>	87457	Power cable IT	–
<b>12</b>	11107881	Power cable JP	–
<b>13</b>	11107880	Power cable TH, PE	–
<b>14</b>	88668	Power cable US	–
<b>15</b>	89728	Power cable ZA	–
<b>16</b>	30134389	Terminal PRAT	Including: protective cover
<b>17</b>	30125377	Protective cover, terminal	For terminal (PRAT, PRPT)
<b>18</b>	30416123	Cable, terminal	–

## 11.2.4 Packaging

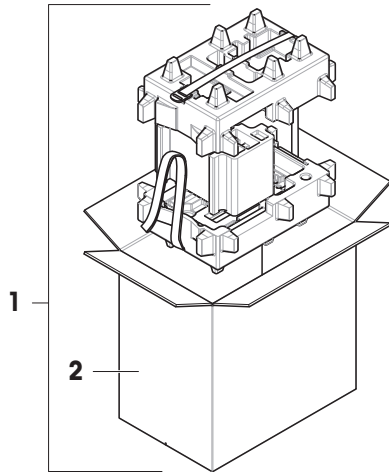

	<b>Order no.</b>	<b>Designation</b>	<b>Remarks</b>
<b>1</b>	30460297	Packaging	Including: Export box, inner protection material
<b>2</b>	30460298	Export box	Excluding: Inner protection material

## 12 Appendix

### 12.1 Approved balances

#### 12.1.1 Definitions

##### Approved balances

Approved balances are balances that are subject to the local, legal requirements of "non-automatic weighing instruments", as defined in OIML R76. For approved balances, the net weighing results must comply with a higher level of control. Approved balances are used, for example, for legal metrology, for weight-based trading, or for determination of mass for the application of laws. The term "approved balance" includes legal-for-trade (LFT) balances, certified balances, and registered balances.

The restrictions and special behaviors of these balances are described in the present section as well as in specific balance settings throughout the manual.

To identify approved balances, the characters /M or /A are appended to the model names.

##### Actual scale interval, **d**

The value **d** represents the "actual scale interval". According to OIML R76-1 [T.3.2.2], it represents the difference between two consecutive indicated values. In some countries, the value **d** is defined as the "scale division" or the "scale division interval". In practice, it is often referred to as the "readability".

##### Verification scale interval, **e**

The value **e** represents the "verification scale interval" [OIML R76-1: T.3.2.3]. This value is used for the classification and verification of an instrument. It represents the absolute accuracy of the instrument and is relevant in the context of market surveillance.

The minimum value of the verification scale interval is 1 mg. [OIML R76-1: 3.2]

#### 12.1.2 Descriptive markings

The descriptive markings of the instrument are on the model label, according to OIML R76-1 [7.1.4]:

- **Min**: minimum capacity
- **Max**: maximum capacity (referred to as "capacity" in this document)
- **e**: verification scale interval
- **d**: actual scale interval

The type label also contains those descriptive markings, as well as other metrological characteristics and limits of the instrument.

#### 12.1.3 Restrictions on zeroing and taring

##### Zeroing the balance

- When switching on the balance, an initial zero is performed. If the load is more than 20% of the balance capacity during the initial zero, the zeroing is not possible and no weighing value is displayed. [OIML R76-1: T.2.7.2.4 and 4.5.1]
- During operation, the range for which a zero can be performed is  $\pm 2\%$  of the balance capacity. [OIML R76-1: 4.5.1]

##### Taring the balance

- It is not possible to tare the balance if the gross weight is negative. [OIML R76-1: 4.6.4]

#### 12.1.4 Factory method: General Weighing

All balances are delivered with a factory method named **General Weighing**. For approved balances:

- The factory method cannot be deleted.
- The unit of the factory method **General Weighing** is set to **g** and cannot be edited.

- When switching on the balance, the factory method is shown on the weighing screen, regardless of which method was running when the balance was switched off.
- For the tolerance profile used by the factory method, the setting **Display readability** is set to **1d** and cannot be edited.

### 12.1.5 Representation of weighing results

The representation of weighing results from approved balances follows rules with respect to the weighing units, the weight value, and the indicator of the type of weight. These rules are described in the following paragraphs.

#### Unit

- A reduced set of units is available for selection.
- Units defined by the user (**Custom unit**) are restricted to characters that cannot be confused with other standard units. The following values are not allowed (uppercase and lowercase letters):
  - all common units, abbreviation or full name, for example, g, gram, kg, ct, oz, etc.
  - c, ca, car, cm, crt, cart, kt, gr, mgr, ugr, kgr, gra, mgra, ugra, kgra, grm, mgrm, ugrm, kgrm, mgram, ugram, kgram, k, kilo, to, tn, sh, tael, dram, dr, lboz, gramme, tonne, livre, once, lbt, cwt, dwt
  - all common units starting with the letter "o", where the "o" is replaced by the number "0", for example, Oz, Ozl, etc.
  - all common units where the letter "s" is added at the end

#### Weighing result

If the actual scale interval is smaller than the verification scale interval ( $d < e$ ), the digits that are smaller than **e**, are called non-verified digits. For balances showing up to four digits ( $d \geq 0.1$  mg), the non-verified digits are marked. For example, a weight of 100 mg placed on a balance with  $e = 1$  mg and  $d = 0.1$  mg would be printed as 100.[0] mg. [OIML R76-1: 3.4.1, 3.4.2]

- primary weight value on the main weighing screen: the non-verified digits are grayed out
- secondary weight value (**Info weight**) on the main weighing screen: the non-verified digits are grayed out
- **Results list**, detailed view: the non-verified digits are in brackets
- **Alibi memory**: the non-verified digits are in brackets
- Printout: the non-verified digits are in brackets
- Data export: no special marking

If custom units are used, the non-verified digits are not marked.

The depiction of the weight values does not affect the accuracy of the weighing results. That is consistent with legal metrology requirements.

#### Indicator for weighing result

The type of weighing result, such as **Net weight**, **Tare weight**, or **Gross weight**, is marked according to OIML R76-1 [T.5.2, T.5.3, 4.6.5, 4.6.11, 4.7].

Indicator	Main weighing screen	Results list	Printout
<b>Net weight</b>	Net	<b>Net weight</b>	<b>N</b>
<b>Tare weight</b>	–	<b>Tare weight</b>	<b>T</b>
<b>Preset tare weight</b>	–	<b>Preset tare weight</b>	<b>PT</b>
<b>Gross weight</b>	–	<b>Gross weight</b>	<b>G</b> <sup>1</sup>
Calculated weight	*	*	*
Unstable weight	o	<b>D</b>	<b>D</b>

<sup>1</sup> If only the gross weight is included on the printout, the indicator **G** is omitted.



### Printout examples

The following examples refer to a balance with **e** = 1 mg and **d** = 0.1 mg. The tare or preset tare value is 200 mg, the gross weight is 743.2 mg and the net weight is 543.2 mg.

- with manual tare:

N	543. [2] mg
T	200. [0] mg
G	743. [2] mg

- with preset tare:

N	* 543. [2] mg
PT	200.0 mg
G	743. [2] mg

### 12.1.6 MT-SICS

The following commands are not available for approved balances:

- **CO**
  - It is not possible to change the adjustment type.
- **TI**
  - It is not possible to do an immediate tare. [OIML R76-1: 4.6.8]
- **ZI**
  - It is not possible to do an immediate zero. [OIML R76-1: 4.5.6]

### 12.1.7 Reference

OIML R 76-1 Edition 2006 (E), Non-automatic weighing instruments, Part 1: Metrological and technical requirements – Tests



# Index

## A

AC/DC adapter	226
acclimatization	
time	32, 225
adjustment	23, 74
external	75
internal	74
setting	213
alibi memory	107
altitude	225
approved balance	124, 253
assemble	
balance	29
draft shield	29
automated dosing	
create a method	54
perform	55
setting	182
automated solution preparation	
create a method	59
setting	190, 191
automatic feeder	49, 130, 169

## B

balance information	109
barcode reader	80, 122
delete	85
below-the-balance weighing	36
block	
balance	96
Bluetooth	121
printer	78, 122
brightness	118

## C

certified balance	
see approved balance	253
clone	
method	63
combined test weight	66
command	
MT-SICS	86, 123
web service	88, 123
compliance information	11
convention	9

create	
eccentricity test	67
method	39
repeatability test	67
sensitivity test	67
user	94
user group	94

## D

delete	
device	85
method	64
RFID reader	85
task	64
density determination	
create a method	46
perform	46
setting	158
device	
barcode reader	80, 122
delete	85
edit setting	85
ErgoSens	84, 122
foot switch	83, 122
peripheral	121
printer	76, 77, 78, 122
pump	84, 122
RFID reader	44, 81, 99, 122
disposal	235
door	
handle	17
open	19
optical sensor	18
release lever	19
setting	116
dosing head	
copy data	99
data fields	99
edit data	55, 99
position	97
unlock	97
draft shield	16
assemble	29
drip tray	16

<b>E</b>			
EasyScan			
see RFID reader	81		
eccentricity test	68		
create	67		
setting	202		
edit			
method	63		
environmental condition	26, 225		
ErgoSens	84, 122		
delete	85		
Ethernet	121		
EULA	32		
external			
adjustment	75		
device	121		
<b>F</b>			
foot switch	83, 122		
delete	85		
<b>G</b>			
general weighing			
create a method	40		
perform	40		
setting	125		
<b>H</b>			
HeightDetect	98		
history	106		
humidity	225		
<b>I</b>			
install			
barcode reader	80		
draft shield	29		
ErgoSens	84		
foot switch	83		
printer	76, 78		
pump	84		
put into operation	31		
RFID reader	81		
site	26		
terminal	28		
interface			
Bluetooth	121		
Ethernet	121		
internal			
adjustment	74		
interval weighing			
create a method	43		
perform	43		
setting	146		
<b>L</b>			
LabX	85, 86, 123		
legal-for-trade balance			
see approved balance	253		
level			
balance	33		
indicator	21		
leveling aid	33, 106		
leveling feet	17		
leveling aid	33, 106		
leveling feet	17		
LFT balance			
see approved balance	253		
light			
StatusLight	118		
location	26		
log in	32, 96		
log out	96		
LV12	49, 130, 169		
<b>M</b>			
main weighing screen	21		
memory			
alibi	107		
method	22		
clone	63		
create	39		
delete	64		
edit	63		
perform	39		
type	39		
module cover	18		
MT-SICS	86, 123		
<b>O</b>			
optical sensor			
door	18		
HeightDetect	98		
SmartSens	18		
overview			
balance	15		

terminal	19	reset	
type label	20	password	95
<b>P</b>		RFID	
pack		reader	44, 81, 99, 122
balance	35	Smart Tag	44, 81
password		tag	99
log in	32	<b>S</b>	
new user	94	safety information	12
reset	95	sample changer	
perform a method		adjust	103
automated dosing	55	control	101
density determination	46	move position	101
general weighing	40	sensitivity test	72
interval weighing	43	create	67
piece counting	52	setting	209
simple formulation	42	service	
SQC	48, 50	LabX	86, 123
titration	45	MT-SICS	86, 123
piece counting		web	88, 123
create a method	52	setting	
perform	52	adjustment	213
setting	173	automated dosing	182
position		automated solution preparation	190, 191
dosing head	97	density determination	158
HeightDetect	98	eccentricity test	202
sample changer	101	general weighing	125
pressure		interval weighing	146
pump	100	piece counting	173
print		repeatability test	206
result	76, 78	sensitivity test	209
test page	77, 79	simple formulation	136
printer	76, 77, 78, 122	SQC	165
delete	85	test	202
install	76, 78	titration	149
test	77, 79	simple formulation	
pump	84, 122	create a method	42
pressure	100	perform	42
<b>R</b>		setting	136
release lever		Smart Tag	44, 81
door	19	SmartGrid	16
removable clip	17	SmartScan	
repeatability test	70	see RFID reader	83
create	67	SmartSens	18
setting	206	SmartTrac	21
		software	
		version	9

sound	
terminal	118
SQC	
create a method	47
perform	48, 50
setting	165
standby	19, 33
StaticDetect	16
StatusLight	18, 118
store	
balance	35
switch on/off	32, 33
symbol	9
warning	12

## T

---

tare	19, 34
task	64
temperature	225
acclimatization time	225
warm-up time	225
terminal	18
brightness	118
install	28
overview	19
sound	118
StatusLight	118
test	22, 66
create	67
eccentricity	68
repeatability	70
sensitivity	72
setting	202
test weight	65, 66
setting	201
time	
acclimatization	32, 225
warm up	32, 225
titration	
create a method	44
perform	45
setting	149
transport	
long distance	35
short distance	35
type label	
overview	20

## U

---

unlock	
balance	96
unpack	
balance	26
USB	
printer	76, 122
see device	121
user	
create	94
delete	94
group	94
management	93
name	32

## W

---

warm up	
time	32, 225
warning symbol	12
web service	88, 123
weighing aid	
SmartTrac	21
weighing pan	16
weighing screen	21
weight	
test weight	65

## Z

---

zero	19, 34
initial	124



## To protect your product's future:

METTLER TOLEDO Service assures the quality, measuring accuracy and preservation of value of this product for years to come.

Please request full details about our attractive terms of service.

► [www.mt.com/service](http://www.mt.com/service)

[www.mt.com/excellence-analytical](http://www.mt.com/excellence-analytical)

For more information

**Mettler-Toledo GmbH**

Im Langacher 44  
8606 Greifensee, Switzerland  
[www.mt.com/contact](http://www.mt.com/contact)

Subject to technical changes.  
© 11/2024 METTLER TOLEDO. All rights reserved.  
30419844I en



30419844