

METTLER TOLEDO

Table of Contents

1	Introduction	3
1.1	Further documents and information	3
1.2	Explanation of conventions and symbols used	3
1.3	Acronyms and abbreviations	4
2	Safety Information	5
2.1	Definition of signal words and warning symbols	5
2.2	Product-specific safety notes	5
3	Design and Function	7
3.1	Overview	7
3.1.1	Balance	7
3.1.2	Operation keys	8
3.1.3	Display	9
3.2	Basic principles for operation	9
4	Installation and Putting into Operation	12
4.1	Selecting the location	12
4.2	Unpacking the balance	12
4.3	Installing components	13
4.4	Connecting the balance	13
4.5	Setting up the balance	14
4.5.1	Switching on the balance	14
4.5.2	Leveling the balance	14
4.5.3	Setting date and time	16
4.5.4	Adjusting the balance	17
4.5.4.1	Adjustment with internal weight	17
4.5.4.2	Adjustment with external weight	17
4.6	Performing a simple weighing	18
4.7	Transporting, packing, and storing	21
4.7.1	Transporting over short distances	21
4.7.2	Transporting over long distances	21
4.7.3	Packing and storing	22
4.8	Weighing below the balance	22
5	The Menu	23
5.1	Menu overview	23
5.2	Description of menu topics	24
5.2.1	Main menu	24
5.2.2	Basic menu	24
5.2.3	Advanced menu	25
5.2.4	Interface menu	27
6	Applications	32
6.1	Application piece counting	32
6.2	Application dynamic weighing	34
7	Communication with Peripheral Devices	36
7.1	PC-Direct function	36
8	Maintenance	38
8.1	Maintenance tasks	38
8.2	Performing routine tests	38
8.3	Cleaning	38
8.3.1	Cleaning the glass draft shield	38
8.3.2	Cleaning the balance	39

8.3.3	Putting into operation after cleaning	39
9	Troubleshooting	41
9.1	Error messages.....	41
9.2	Error symptoms	42
9.3	Putting into operation after troubleshooting.....	45
10	Technical Data	46
10.1	General data.....	46
10.2	Model-specific data	47
10.2.1	Balances with readability of 0.1 mg.....	47
10.2.2	Balances with readability of 1 mg.....	49
10.2.3	Balances with readability of 10 mg.....	51
10.3	Dimensions	53
10.3.1	Balances with readability of 0.1 mg.....	53
10.3.2	Balances with readability of 1 mg.....	54
10.3.3	Balances with readability of 10 mg.....	55
10.4	Interface specification	56
10.4.1	RS232C interface.....	56
10.4.2	MT-SICS interface commands and functions.....	56
11	Accessories and Spare Parts	57
11.1	Accessories	57
11.2	Spare parts.....	60
11.2.1	LA balances, readability 0.1 mg	60
11.2.2	LA balances, readability 1 mg	61
11.2.3	LA balances, readability 10 mg	62
11.2.4	AC/DC adapter, universal	63
11.2.5	Packaging	64
11.2.5.1	Packaging for balances with readability of 0.1 mg	64
11.2.5.2	Packaging for balances with readability of 1 mg	65
11.2.5.3	Packaging for balances with readability of 10 mg	65
12	Disposal	67
13	Compliance Information	68
	Index	69

1 Introduction

Thank you for choosing a METTLER TOLEDO balance. The balance combines high performance with ease of use.

This document is based on the software version V 1.00.

EULA

The software in this product is licensed under the METTLER TOLEDO End User License Agreement (EULA) for Software.

When using this product you agree to the terms of the EULA.

▶ www.mt.com/EULA

1.1 Further documents and information

This document is available in other languages online.



▶ www.mt.com/LA-RM

Product page:

▶ www.mt.com/LA-balances

Instructions for cleaning a balance, "8 Steps to a Clean Balance":

▶ www.mt.com/lab-cleaning-guide

Search for software:

▶ www.mt.com/labweighing-software-download

Search for documents:

▶ www.mt.com/library

For further questions, please contact your authorized METTLER TOLEDO dealer or service representative.

▶ www.mt.com/contact

1.2 Explanation of conventions and symbols used

Conventions and symbols

Key and/or button designations and display texts are shown in graphic or bold text, e.g.,  **DATE**.

 **Note** For useful information about the product.



Refers to an external document.



This symbol indicates press key briefly (less than 1.5 s).



This symbol indicates press and hold key down (longer than 1.5 s).



This symbol indicates a flashing display.

Elements of instructions

In this manual, step-by-step instructions are presented as follows. The action steps are numbered and can contain prerequisites, intermediate results and results, as shown in the example. Sequences with less than two steps are not numbered.

- Prerequisites that must be fulfilled before the individual steps can be executed.
- 1 Step 1
 - ➔ Intermediate result
- 2 Step 2
 - ➔ Result

1.3 Acronyms and abbreviations

Original term	Explanation
AC	Alternating Current
ASTM	American Society for Testing and Materials
DC	Direct Current
EMC	Electromagnetic Compatibility
FCC	Federal Communications Commission
ID	Identification
LPS	Limited Power Source
MT-SICS	METTLER TOLEDO Standard Interface Command Set
OIML	Organisation Internationale de Métrologie Légale (International Organization of Legal Metrology)
RM	Reference Manual
SNR	Serial Number
SOP	Standard Operating Procedure
UM	User Manual
USB	Universal Serial Bus
USP	United States Pharmacopeia

2 Safety Information

Two documents named "User Manual" and "Reference Manual" are available for this instrument.

- The User Manual is available online in various languages.
- A printed version of the User Manual is delivered with the instrument.
- The Reference Manual is available online. This manual contains a full description of the instrument and its use.
- Keep both documents for future reference.
- Include both documents if you transfer the instrument to other parties.

Only use the instrument according to the User Manual and the Reference Manual. If you do not use the instrument according to these documents or if the instrument is modified, the safety of the instrument may be impaired and Mettler-Toledo GmbH assumes no liability.

2.1 Definition of signal words and warning symbols

Safety notes contain important information on safety issues. Ignoring the safety notes may lead to personal injury, damage to the instrument, malfunctions and false results. Safety notes are marked with the following signal words and warning symbols:

Signal words

DANGER	A hazardous situation with high risk, resulting in death or severe injury if not avoided.
WARNING	A hazardous situation with medium risk, possibly resulting in death or severe injury if not avoided.
CAUTION	A hazardous situation with low risk, resulting in minor or moderate injury if not avoided.
NOTICE	A hazardous situation with low risk, resulting in damage to the instrument, other material damage, malfunctions and erroneous results, or loss of data.

Warning symbols



General hazard



Notice

2.2 Product-specific safety notes

Intended use

This instrument is designed to be used by trained staff. The instrument is intended for weighing purposes.

Any other type of use and operation beyond the limits of use stated by Mettler-Toledo GmbH without consent from Mettler-Toledo GmbH is considered as not intended.

Responsibilities of the instrument owner

The instrument owner is the person holding the legal title to the instrument and who uses the instrument or authorizes any person to use it, or the person who is deemed by law to be the operator of the instrument. The instrument owner is responsible for the safety of all users of the instrument and third parties.

Mettler-Toledo GmbH assumes that the instrument owner trains users to safely use the instrument in their workplace and deal with potential hazards. Mettler-Toledo GmbH assumes that the instrument owner provides the necessary protective gear.

Safety notes



WARNING

Death or serious injury due to electric shock

Contact with parts that carry a live current can lead to death or injury.

- 1 Only use the METTLER TOLEDO power cable and AC/DC adapter designed for your instrument.
- 2 Connect the power cable to a grounded power outlet.
- 3 Keep all electrical cables and connections away from liquids and moisture.
- 4 Check the cables and the power plug for damage and replace them if damaged.



NOTICE

Damage to the instrument or malfunction due to the use of unsuitable parts

- Only use parts from METTLER TOLEDO that are intended to be used with your instrument.

3 Design and Function

3.1 Overview

3.1.1 Balance

0.1 mg

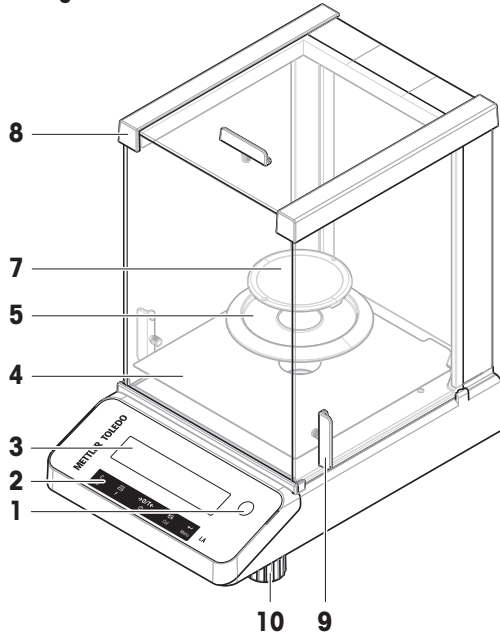

1 mg

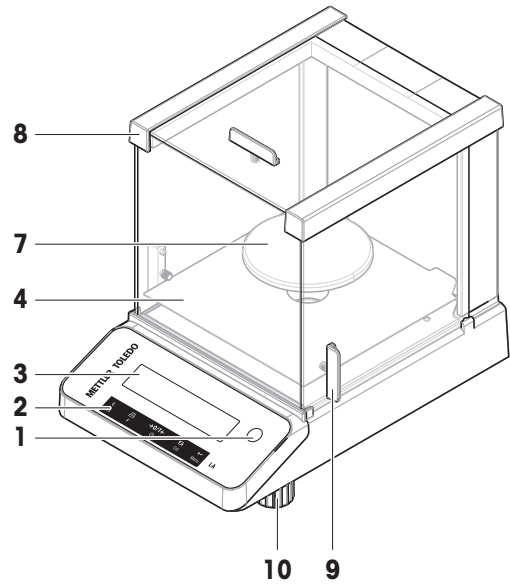

10 mg

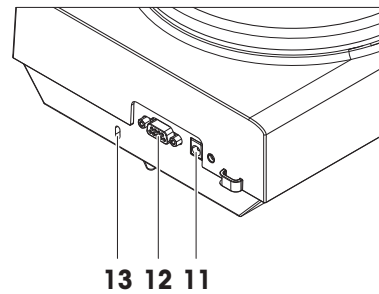
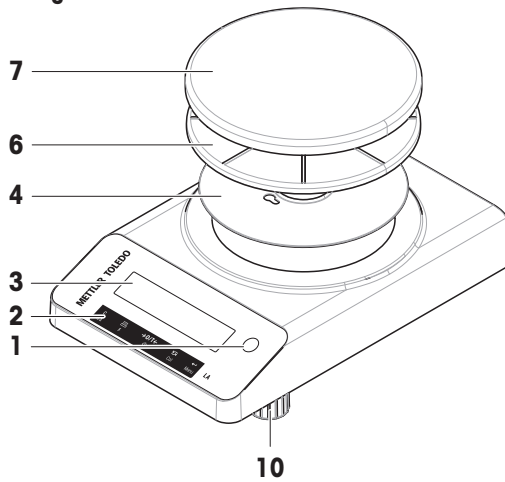

1	Level indicator	8	Draft shield
2	Operation keys	9	Door handle
3	Display	10	Leveling feet
4	Bottom plate	11	Socket for AC/DC adapter
5	Draft-protection element	12	RS232C serial interface
6	Weighing pan support	13	Slot for anti-theft purposes
7	Weighing pan		

3.1.2 Operation keys



No.	Key	Press briefly (less than 1.5 s)	Press and hold (longer than 1.5 s)
1	C ΔΔ	<ul style="list-style-type: none"> Cancel or leave menu without saving One step back in the menu Shortcut for changing the readability of the display (display increment function 1/10d) while simple weighing application is performed. <p>Note This function is not available for approved balances.</p>	<ul style="list-style-type: none"> Select the simple weighing application Exit application
2	 F	<ul style="list-style-type: none"> Print display value Transmit data To navigate backwards in the menu or menu selection Decrease parameters in menu or applications 	<ul style="list-style-type: none"> Open the application list for selecting an application
3	→0/T← ⏻	<ul style="list-style-type: none"> Zero/Tare Switch on 	<ul style="list-style-type: none"> Switch off into standby mode
4	 Cal	<ul style="list-style-type: none"> With entries, scroll down To navigate forward menu topics or menu selections To toggle between unit 1, recall value (if selected), unit 2 (if different from unit 1) and the application unit (if any) Increase parameters in menu or applications. 	<ul style="list-style-type: none"> Execute predefined adjustment procedure
5	↵ Menu	<ul style="list-style-type: none"> Enter or leave menu selection To enter application parameter digit and switch to next parameter digit To accept parameter in menu selection. 	<ul style="list-style-type: none"> Enter or leave menu (parameter settings) To store parameter To accept numeric inputs in applications.

3.1.3 Display

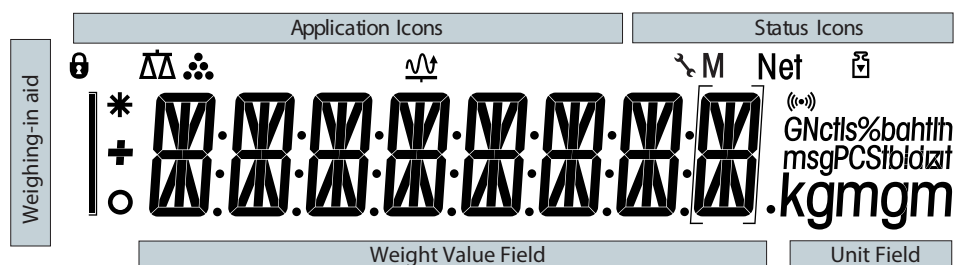

Application Icons			
	Application "Weighing"		Application "Dynamic weighing"
	Application "Piece counting"		Menu locked

While an application is running, the corresponding application icon appears at the top of the display.

Status Icons			
M	Indicates stored value (Memory)		Feedback for pressed keys
Net	Indicates Net weight values		Adjustments started

Weight Value Field and Weighing-in aid			
	Indicates negative values		Indicates calculated values
	Indicates unstable values		Brackets to indicate uncertified digits (approved models only)

Unit field						
GNctls%bahtlh msgPCStbdzft kgmgm	g	gram	ozt	troy ounce	tlh	Singapore taels
	kg	kilogram	GN	grain	tlt	Taiwan taels
	mg	milligram	dwt	pennyweight	tola	tola
	ct	carat	mom	momme	baht	baht
	lb	pound	msg	mesghal		
	oz	ounce	tlh	Hong Kong taels		

Note

The available units and the default unit are country specific.

3.2 Basic principles for operation

Selecting simple weighing or terminate application

- Press and hold until **WEIGH** appears on the display.
 - ➔ The balance returns to the simple weighing mode.

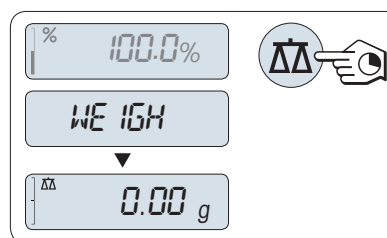

Note

How to perform simple weighing **see** Performing a simple weighing.

Selecting an application

- 1 Press and hold **F** until **APP.LIST** (application list).
➔ Last active application, e.g., **COUNT** appears on the display.
- 2 Select an application by multiple pressing ↻.
- 3 Press ↵ to execute selected application.

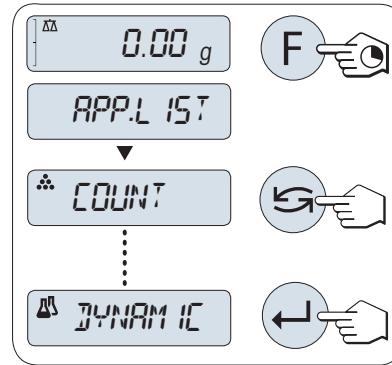

Available applications

Display	Remark	Description
COUNT	Piece counting	see Application "Piece Counting"
DYNAMIC	Dynamic weighing	see Application "Dynamic Weighing"

Entering the menu

- 1 Press and hold **Menu** to enter main menu.
➔ The first menu **BASIC** is displayed (except menu protection is active).
- 2 Press ↻ repeatedly to change menu.
- 3 Press ↵ to confirm the selection.

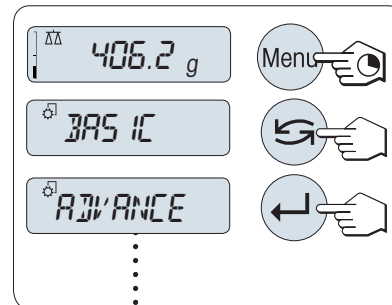

Selecting menu topics

- 1 Press ↻.
➔ The next menu topic appears in the display.
- 2 Press ↻ repeatedly, the balance switches to the next menu topic.

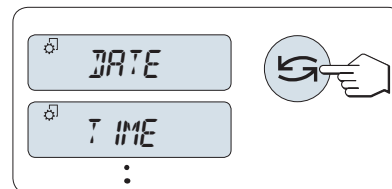

Changing settings in selected menu topic

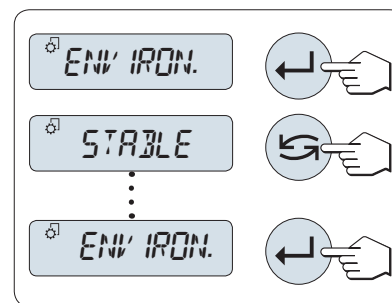

- 1 Press ↵.
➔ The display shows the current setting in the selected menu topic.
 - 2 Press ↻ repeatedly, the balance switches to the next selection.
➔ After the last selection, the first is shown again.
 - 3 Press ↵ to confirm the setting.
- To save the settings, see "Saving settings and closing the menu".



Changing settings in a submenu selection



The same procedure as for menu topics.

Input principle of numerical values

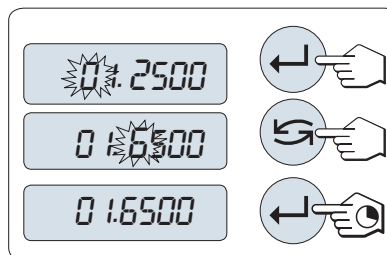
- 1 Press  to select a digit (cyclically from left to right) or a value (depending on the application).
➔ The selected digit or the selected value is blinking.
- 2 Press  to increase or **F** to decrease for changing blinking digits or values.
- 3 Press and hold  to confirm the value.



Saving settings and closing the menu

- 1 Press and hold **Menu** to leave menu topic.
➔ **SAVE:YES** appears on the display.
- 2 Press  to toggle between **SAVE:YES** and **SAVE:NO**.
- 3 Press  to execute **SAVE:YES**.
➔ Changes are saved.
- 4 Press  to execute **SAVE:NO**.
➔ Changes are not saved.

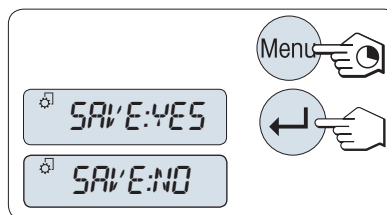

Cancel

- During menu operation
 - Press **C** for leaving menu topic or menu selection without saving (one step back in the menu).
- During application operation
 - Press **C** to cancel settings.
➔ The balance returns to the previous active application.

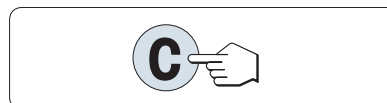

Note

If no entry is made within 30 seconds, the balance reverts to last active application mode. Changes are not saved. If changes are made, the balance asks **SAVE:NO**.

4 Installation and Putting into Operation

4.1 Selecting the location

A balance is a sensitive precision instrument. The location where it is placed will have a profound effect on the accuracy of the weighing results.

Requirements of the location

Place indoors on stable table



Avoid direct sunlight

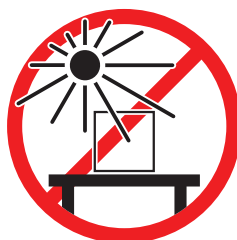

Ensure sufficient spacing

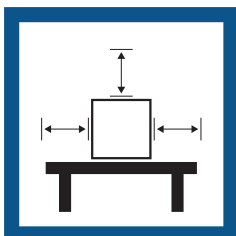

Avoid vibrations



Level the instrument



Avoid strong drafts



Provide adequate lighting

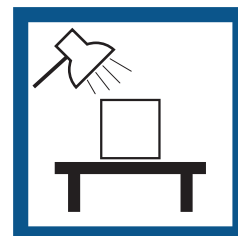

Avoid temperature fluctuations



Sufficient spacing for balances: > 15 cm all around the instrument

Take into account the environmental conditions. See "Technical Data".

See also

 General data ▶ Page 46

4.2 Unpacking the balance

Open the balance packaging. Check the balance for transport damage. Immediately inform a METTLER TOLEDO representative in the event of complaints or missing accessories.

Retain all parts of the packaging. This packaging offers the best possible protection for transporting the balance.

4.3 Installing components

Balances with draft shield

- 1 Fully open the side door (1).
- 2 Insert the bottom plate (2).
- 3 Only for balances with a readability of 0.1 mg: Place the draft-protection element (3) on top of the bottom plate (2).
- 4 Install the weighing pan (4).

Further information for cleaning the draft shield, **see** chapter "Cleaning the glass draft shield".

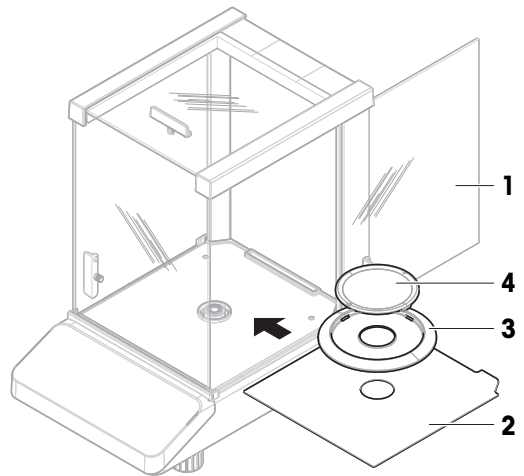

Balances without draft shield

- 1 Install the bottom plate (1).
- 2 Install the weighing pan support (2).
- 3 Install the weighing pan (3).

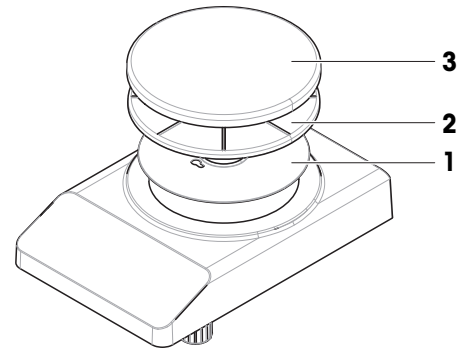

4.4 Connecting the balance



WARNING

Death or serious injury due to electric shock

Contact with parts that carry a live current can lead to death or injury.

- 1 Only use the METTLER TOLEDO power cable and AC/DC adapter designed for your instrument.
- 2 Connect the power cable to a grounded power outlet.
- 3 Keep all electrical cables and connections away from liquids and moisture.
- 4 Check the cables and the power plug for damage and replace them if damaged.



NOTICE

Damage to the AC/DC adapter due to overheating

If the AC/DC adapter is covered or in a container, it is not sufficiently cooled and will overheat.

- 1 Do not cover the AC/DC adapter.
- 2 Do not put the AC/DC adapter in a container.

- Install the cables so that they cannot be damaged or interfere with operation.

- Insert the power cable in a grounded power outlet that is easily accessible.

- 1 Connect the AC/DC adapter (1) to the connection socket on the back of your balance.
- 2 Connect the power cable (2) to the power socket.
 - ➔ The balance performs a display test (all segments in the display light up briefly), **WELCOME**, **Software version**, **Maximum load** and **Readability** appears briefly.
 - ➔ The balance is ready to be used.

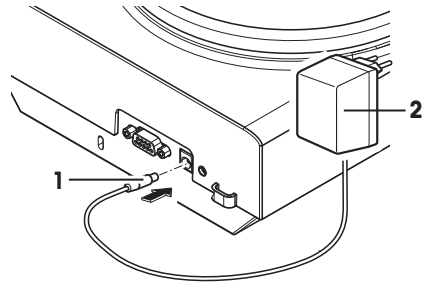

Note

Always connect the AC/DC adapter to the balance before connecting to the power.

Do not connect the instrument to a power outlet controlled by a switch. After switching on the instrument, it must warm up before giving accurate results.

See also

[General data](#) ▶ Page 46

4.5 Setting up the balance

4.5.1 Switching on the balance

Before using the balance, it must be warmed up in order to obtain accurate weighing results. To reach operating temperature, the balance must be connected to the power supply for at least 30 minutes (60 minutes for 0.1 mg models).

- The balance is connected to the power supply.
- The balance is in **STANDBY** mode. **MT.GREEN** appears on the display.
- Press .
- ➔ The balance is ready for weighing or for operation with the last active application.

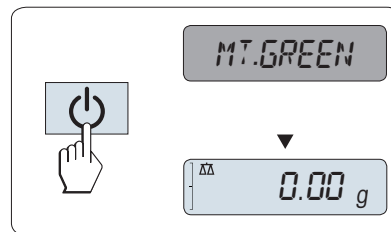

Approved balances

Standby mode is not possible with approved balances (only available in selected countries).

See also

[General data](#) ▶ Page 46

4.5.2 Leveling the balance

Exact horizontal and stable positioning are essential for repeatable and accurate weighing results.

There are two adjustable leveling feet to compensate for slight irregularities in the surface of the weighing bench.

The balance must be leveled and adjusted each time it is moved to a new location.

- 1 Position the balance at the selected location.
- 2 Align the balance horizontally.
- 3 Turning the two front leveling feet of the housing until the air bubble is in the middle of the glass.

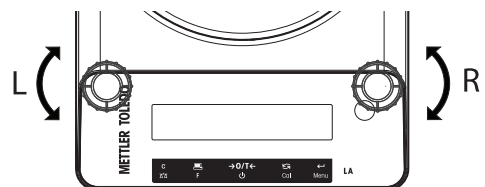

Example

Air bubble at 12 o'clock:



Turn both feet clockwise.



Air bubble at 3 o'clock:



Turn left foot clockwise, turn right foot counterclockwise.

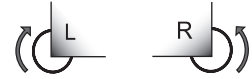

Air bubble at 6 o'clock:



Turn both feet counterclockwise.



Air bubble at 9 o'clock:



Turn left foot counterclockwise, turn right foot clockwise.



4.5.3 Setting date and time

When you put your new instrument into operation for the first time, you should enter the current date and time.

i Note

- These settings are retained even if you disconnect your instrument from the power supply.
- A reset of the instrument will not change these settings.
- Set the current date according to the date format **DATE.FRM** in the menu **ADVANCE..**
- Set the current time according to the time format **TIME.FRM** in the menu **ADVANCE..**

- 1 Press and hold **Menu** until menu **BASIC** appears on the display.
- 2 Press **←** to open menu **BASIC**.
→ **DATE** appears.
- 3 Press **←** to confirm.
- 4 **Set current date.** Press **←** to select day, month or year; press **↻** to set current day, month or year.
- 5 Press and hold **←** to confirm the settings.
→ **DATE** appears..
- 6 **Set current time.** Press **↻** to select **TIME**.
- 7 Press **←** to confirm.
→ **+1H** appears.
- 8 Select **SET.TIME** by pressing **↻**.
- 9 Press **←** to confirm.
- 10 Press **←** to select hours or minutes; press **↻** to set current hours or minutes.
- 11 Press and hold **←** to confirm the settings.
→ **TIME** appears.
- 12 Press and hold **←** to store the settings.
→ **SAVE:YES** appears.
- 13 Press **←** to confirm.

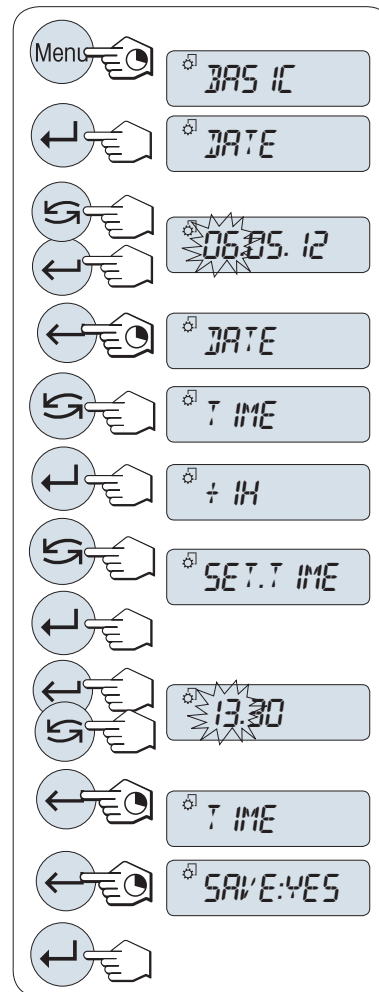

4.5.4 Adjusting the balance

To obtain accurate weighing results, the balance must be adjusted to match the gravitational acceleration at its location. This is also dependent on the ambient conditions. After reaching the operating temperature, it is important to adjust the balance in the following cases:

- Before the balance is used for the first time.
- If the balance has been disconnected from the power supply or in the event of power failure.
- After significant environmental changes, e.g., temperature, humidity, air draft or vibrations.
- At regular intervals during weighing service.

4.5.4.1 Adjustment with internal weight

This section only applies to balance models with an internal weight.

- The weighing pan is empty.
- Press and hold **CAL** to execute the internal adjustment.
 - ➔ The balance adjusts itself automatically.
- ➔ The adjusting is finished when the message **ADJ DONE** appears briefly on the display. The balance returns to the last active application and is ready for operation.

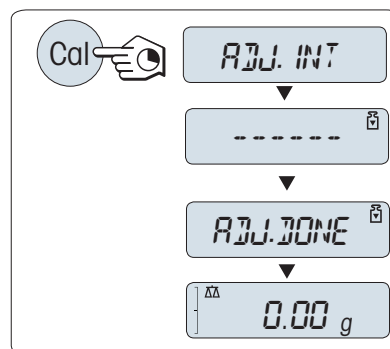

See also

- [Advanced menu](#) ▶ Page 25
- [Model-specific data](#) ▶ Page 47

4.5.4.2 Adjustment with external weight



NOTICE

Before adjusting the balance, it must be warmed up.

i Note

Because of certification legislation, the approved models cannot be adjusted with an external weight* (depending on selected countries' certification legislation).

* except OIML accuracy class I approved models.

- Required test weight is available.
 - The weighing pan is empty.
- 1 Press and hold **CAL** to execute external adjustment.
 - ➔ The required adjustment weight value flashes in the display.
 - 2 Place the test weight at the center of the weighing pan.
 - ➔ The balance adjusts itself automatically.
 - 3 When **0.00 g** is flashing, remove the test weight.
 - ➔ The adjustment is finished when the message **ADJ.DONE** appears briefly on the display. The balance returns to the last active application and is ready for operation.

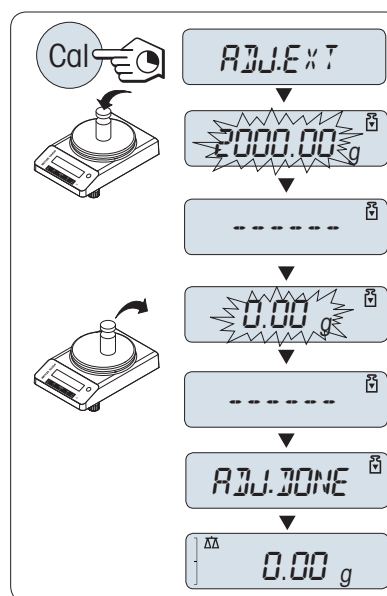

See also

- 🔗 Advanced menu ▶ Page 25
- 🔗 Model-specific data ▶ Page 47

4.6 Performing a simple weighing



The weighing application allows you to perform simple weighings.

If your balance is not in the weighing mode, press and hold the $\Delta\Delta$ key down until **WEIGH** appears in the display. Release the key. Your balance is in the weighing mode and set to zero.

- 1 Press **→0/←** to zero the balance.
- 2 Place the sample on the weighing pan.
- 3 Wait until the instability detector \circ disappears.
- 4 Read the result.

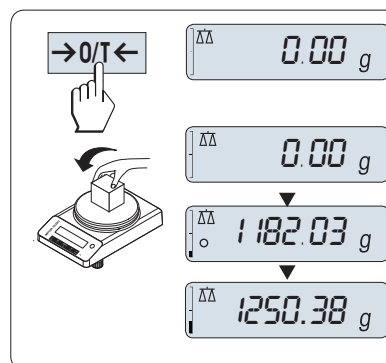

Zeroing

Use the $\rightarrow 0/T \leftarrow$ zeroing key before you start with a weighing.

- 1 Unload the balance.
- 2 Press $\rightarrow 0/T \leftarrow$ to zero the balance.
 - ➔ All weight values are measured in relation to this zero point.

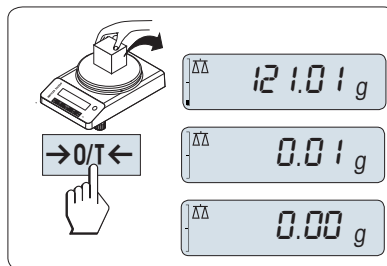

Taring

If you are working with a weighing container, first set the balance to zero.

- 1 Place empty container on the weighing pan.
 - ➔ The weight is displayed.
- 2 Press $\rightarrow 0/T \leftarrow$ to set the balance to zero.
 - ➔ **0.00 g** appears in the display.
- 3 Place weighing sample into the weighing container.
 - ➔ The result appears in the display.

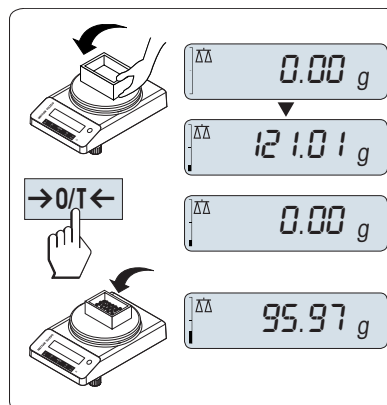

Switching weight units

The $\rightarrow \leftarrow$ key can be used at any time to toggle between weight unit **UNIT 1**, **RECALL** value (if selected) and weight unit **UNIT 2** (if different from weight unit 1) and the application unit (if any).

- Press $\rightarrow \leftarrow$ to set weight unit or recall value.

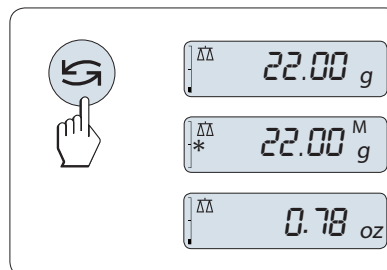

Recall / recall weight value

Recall stores stable weights with an absolute display value bigger than 10d.

- Function **RECALL** is in the menu activated.
- 1 Load weighing sample.
 - ➔ The display shows weight value and stores stable value.
- 2 Remove weighing sample.
 - ➔ The display shows zero.
- 3 Press .
 - ➔ The display shows last stored stable weight value for 5 seconds together with asterisk (*) and memory (M) symbols. After 5 seconds the display goes back to zero. This can be repeated unlimited times.

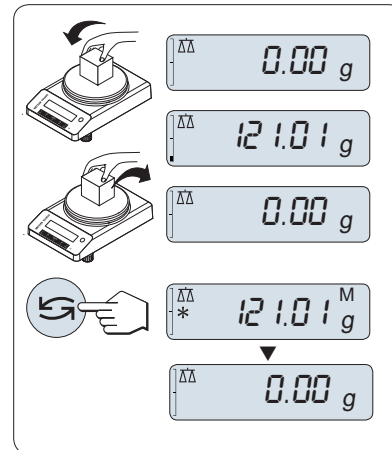

Delete last weight value

As soon a new stable weight value is displayed, the old recall value becomes replaced by the new weight value.

- Press $\rightarrow 0/T \leftarrow$.
 - ➔ The recall value is set to 0.

If the power is switched off, the recall value is lost. The recall value can not be printed.

Weighing with the weighing-in aid

The weighing-in aid is a dynamic graphic indicator which shows the used amount of the total weighing range. You can thus recognize at a glance when the load on the balance approaches the maximum load.

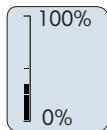

Print / transmit data

Press the  key to transmit the weighing results over the interface, e.g., to a printer or a computer.

Switching off

- Press and hold the  key until **STANDBY** appears on the display. Release the key.
- ➔ **MT.GREEN** appears on the display.
- After switching on from standby mode, your balance needs no warm-up time and is immediately ready for weighing.
- To completely switch off the balance, disconnect it from the power supply.

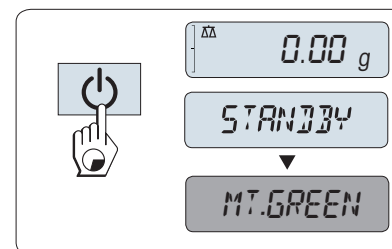

Approved balances

Standby mode is not possible with approved balances (only available in selected countries).

4.7 Transporting, packing, and storing



CAUTION

Injury due to breaking glass

Careless handling with the glass components can lead to breakage of glass and damage to cuttings.

- 1 Do not lift the instrument by the glass draft shield.
- 2 Always proceed focused and with care.

- 1 Press and hold the  key.
- 2 Disconnect the balance from the power supply.
- 3 Disconnect all interface cables.

4.7.1 Transporting over short distances

To move the balance over a short distance to a new location, follow the instructions below.



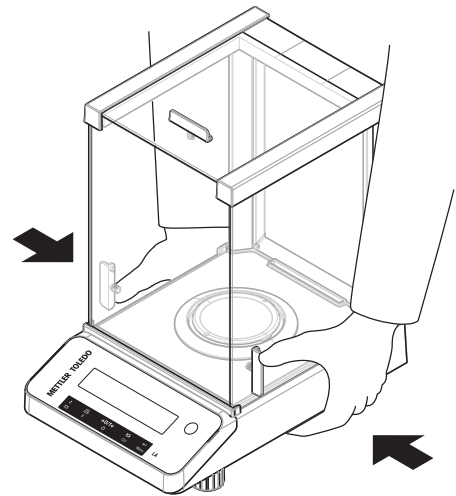

- 1 Hold the balance with both hands as shown.
- 2 Carefully lift the balance and carry it to its new location.

If you wish to put the balance into operation, proceed as follows:

- 1 Connect in reverse order.
- 2 Level the balance.
- 3 Perform an adjustment.



See also

-  [Selecting the location](#) ▶ Page 12
-  [Switching on the balance](#) ▶ Page 14
-  [Leveling the balance](#) ▶ Page 14
-  [Adjusting the balance](#) ▶ Page 17

4.7.2 Transporting over long distances

To transport the balance over long distances, always use the original packaging.

See also

-  [Unpacking the balance](#) ▶ Page 12

4.7.3 Packing and storing

Packing

Store all parts of the packaging in a safe place. The elements of the original packaging are developed specifically for the balance and its components to ensure maximum protection during transportation or storing.

Storing

Store the balance under following conditions:

- Indoor and in the original packaging.
- According to the environmental condition, see "Technical data".
- When storing for longer than two days, the backup battery may be down (date and time get lost).

See also

 Technical Data ▶ Page 46

4.8 Weighing below the balance

Your balance is equipped with a weighing hook for performing weighing operations below the work surface (weighing below the balance).



NOTICE

Damage to balance

Do not place the balance on the pan support location bolt.

- 1 Press and hold the  key.
- 2 Disconnect the balance from the power supply.
- 3 Disconnect all interface cables.
- 4 Remove weighing pan, pan support and bottom plate if present.
- 5 Turn the balance carefully on its side.
- 6 Remove the weighing cap (keep it for later use). The weighing hook is now accessible.
- 7 Turn the balance to its normal position and simply reinstall all components in the reverse order.

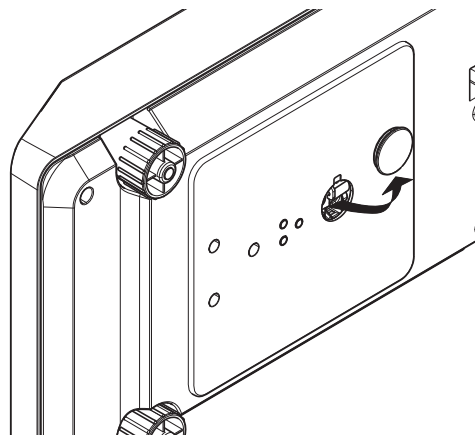

5 The Menu

5.1 Menu overview

In the menu you can change the settings of your balance and activate functions. The main menu has four different submenus containing different topics with various options.

For Menu **PROTECT**, see [Main menu ▶ Page 24].

Menu BASIC

Topic	Description
DATE	Setting the current date.
TIME	Setting the current time.
UNIT 1	Specification of the 1 st weight unit in which the balance should show the result.
UNIT 2	Specification of the 2 nd weight unit in which the balance should show the result.
SET ID	Setting an identification.
PRT.MENU	Printing the settings.
RESET	Call up of the factory settings.

Menu ADVANCE.

Topic	Description
ENVIRON.	Matching the balance to the ambient conditions.
CAL	Settings for adjustment.
DATE.FRM	Setting the date format.
TIME.FRM	Preselection of the time format.
RECALL	Switching the application recall for storing stable weights on or off.
STANDBY	Setting the time after which the balance should be switched off automatically.
B.LIGHT	Switching on or off the display backlight.
A.ZERO	Switching the automatic zero correction (Autozero) on or off.
ZERO.RNG	Setting the zero limit of the zero/tare key.
SRV.ICON	Switching the service reminder (service icon) on or off.
SRV.D.RST	Reset service date and hours (service reminder).

Menu INT.FACE

Topic	Description
RS232	Matching the serial interface RS232C to a peripheral unit.
HEADER	Setting the header for printout of individual values.
SINGLE	Setting the information for printout of individual values.
SIGN.L	Setting the footer for printout of individual values.
LN.FEED	Setting line feed for printout of individual values.
ZERO.PRT	Setting the auto print function for printing zero.
COM.SET	Setting the data communication format of the serial interface RS232C.
BAUD	Setting the transfer speed of the serial interface RS232C.
BIT.PAR.	Setting the character format (Bit/Parity) of the serial interface RS232C.
STOPBIT	Setting the character format (stop bit) of the serial interface RS232C.
HD.SHK	Setting the transfer protocol (Handshake) of the serial interface RS232C.
RS.TX.E.O.L.	Setting the end of line format of the serial interface RS232C.
RS.CHAR	Setting the char set of the serial interface RS232C.

Topic	Description
INTERVL.	Selection of the time interval for the simulated print key press.

5.2 Description of menu topics

In this section you will find information regarding the individual menu topics and the available selections.

5.2.1 Main menu

Selecting the submenu.

BASIC	The BASIC menu for simple weighing is displayed.
ADVANCE.	The ADVANCE. menu for further weighing settings is displayed.
INT.FACE	The menu INT.FACE for all interface parameter settings for peripheral devices e.g. printer is displayed.
PROTECT	The menu PROTECT for protection of the balance configurations against unintended manipulation.

5.2.2 Basic menu

DATE – Date

Setting the current date according to date format.

Note

A reset of the balance will not change this setting.

TIME – Time

Setting the current time according to time format

+1H	Set the current time forwards by 1 hour (to adjust summer or winter time). (Factory setting)
-1H	Set the current time backwards by 1 hour (to adjust summer or winter time).
SET TIME	Enter the current time.

Note

A reset of the balance will not change this setting.

UNIT 1 – Weight unit 1

The balance can operate with the following units (country and model specific).

Approved balances

- Only those weight units allowed by the appropriate national legislation are selectable.
- With approved balances, this menu topic has a fixed setting and cannot be changed.

Units:

g	Gram	dwt	Pennyweight
kg	Kilogram	mom	Momme
mg	Milligram	msg	Mesghal
ct	Carat	tlh	Tael Hong Kong
lb	Pound	tis	Tael Singapore
oz	Ounce (avdp)	tlt	Tael Taiwan
ozt	Ounce (troy)	tola	Tola
GN	Grain	baht	Baht

UNIT 2 – Weight unit 2

If it is required to show the weighing results in weighing mode in an additional unit, the desired second weight unit can be selected in this menu topic (country and model specific). Units see **UNIT 1**.

Approved balances

Only those weight units allowed by the appropriate national legislation are selectable.



SET ID – Set identification

This menu topic allows you to set your own desired identification to the balance for the convenience of asset management or other purposes. The ID can be printed with other balance information. One ID can be set and max 7 alphanumeric characters are possible (blank, 0...9, A...Z).

SET ID

Set identification

The setting starts from left to right and the display prompts the configurable position by flashing corresponding place.

- **SET ID** is selected.
- 1 Search through (blank, 0...9, A...Z) by pressing .
- 2 After selecting the character, press  to confirm and move to the next place. To store press and hold .

PRT.MENU – Print menu

This menu topic allows you to execute a printout of the menu settings if a printer is connected. This topic is only visible if **PRINTER** mode is selected.

- **PRT.MENU** appears on the display and a printer is properly connected.
- To execute a printout press .

RESET – Reset balance settings

This menu topic allows you to call-up the factory settings.

To toggle between **YES?** and **NO?** press .

Note

A reset of the balance will not change **DATE**, **TIME**, **SET ID** and **ZERO.RNG** settings.

5.2.3 Advanced menu

ENVIRON. – Environment settings

This setting can be used to match your balance to the ambient conditions.

STD.

Setting for an average working environment subject to moderate variations in the ambient conditions. (**Factory setting**)

UNSTAB.

Setting for a working environment where the conditions are continuously changing.

STABLE

Setting for a working environment which is practically free from drafts and vibrations.

CAL – Adjustment

In this menu topic you can preselect the function of the **Cal** key. Your balance can be adjusted with internal or external weights by pressing the **Cal** key. If you have attached a printer to your balance, the data of the adjustment are printed out.

ADJ.OFF

The adjustment is **switched off**. The **Cal** key has no function.

ADJ.INT

Internal adjustment: adjustment is performed at a keystroke with the built-in weight (only for models with internal weight, see "Technical Data").

ADJ.EXT

External adjustment: adjustment is performed at a keystroke with a selectable external weight.

Note

This function is not available for approved balances * (depends on selected countries' certification legislation).

* except OIML accuracy class I approved models.

200.00 g

Defining the external adjustment weight: define the weight of the external adjustment weight (in grams). **Factory setting:** depending on the model.

DATE.FRM – Date format

This menu topic allows you to preselect the date format.

The following date formats are available:

	Display examples	Printing examples
DD.MM.Y	01.02.09	01.02.2009
MM/DD/Y	02/01/09	02/01/2009
Y-MM-DD	09-02-01	2009-02-01
D.MMM Y	1.FEB.09	1.FEB 2009
MMM D Y	FEB.1.09	FEB 1 2009

Factory setting: DD.MM.Y

TIME.FRM – Time format

This menu topic allows you to preselect the time format.

The following date formats are available:

	Display examples
24:MM	15:04
12:MM	3:04 PM
24.MM	15.04
12.MM	3.04 PM

Factory setting: 24:MM

RECALL – Recall

This menu topic allows you to switch the **RECALL** function on or off. When it is switched on recall stores the last stable weight if the absolute display value was bigger than 10d.

OFF	RECALL switched off . (Factory setting)
ON	RECALL switched on .

The recall value is displayed with an asterisk and cannot be printed.

STANDBY – Automatic standby

If the automatic standby function is activated, the balance automatically switches itself after a pre selected time of inactivity into the energy saver mode **STANDBY** (e.g., with no key being pressed and no changes of weight occurring).

A.OFF	Automatic standby deactivated.
A.ON	Automatic standby activated. (Factory setting)
10	Time in minutes of inactivity for activating standby function.

B.LIGHT – Backlight

Under this menu topic, the display backlight can be switched off or on.

- | | |
|-----------------|------------------------------------------------------------|
| B.L. ON | Backlight is always on . (Factory setting) |
| B.L. OFF | Backlight is always off . |

A.ZERO – Automatic zero setting

This menu topic allows you to switch the automatic zero setting on or off.

- | | |
|------------|-----------------------------------------------------------------------------------------------------------------------------------------------------------------------------------------------------------------------|
| ON | A.ZERO switched on (Factory setting) . The automatic zero setting continuously corrects possible variations in the zero point that might be caused through small amounts of contamination on the weighing pan. |
| OFF | A.ZERO switched off . The zero point is not automatically corrected. This setting is advantageous for special applications, e.g., evaporation measurements. |

Approved balances

With approved balances, this setting is not available in selected countries.

ZERO.RNG – Zero range

This menu topic allows you to set a zero limit for the $\rightarrow 0/T \leftarrow$ key. Up to and including this limit the $\rightarrow 0/T \leftarrow$ key will execute a zero. Above this limit the $\rightarrow 0/T \leftarrow$ key will execute a tare.



- | | |
|-------------|----------------------------------------------------------------------------------------------|
| 21 g | To set the upper limit of the zeroing range as weight in the definition unit of the balance. |
|-------------|----------------------------------------------------------------------------------------------|

Note

A reset of the balance will not change this setting.

SRV.ICON – Service reminder

This menu topic allows you to switch the service reminder  on or off.

- | | |
|------------|---------------------------------------------------------------------------------------------------------------------------------------------------------------------------------------------------------------------------------------------------------------------------------------------------------------------------------------------------------|
| ON | Service reminder  switched on . You will be informed to call service for recalibration. This will be indicated by the flashing service icon:  . (Factory setting) |
| OFF | Service reminder  switched off . |

SRV.D.RST – Service date reset

This menu topic allows you to reset service date.

Note

This menu topic is only available if **SRV.ICON** setting **ON** was selected.

To toggle between **YES?** and **NO?** press .

5.2.4 Interface menu

RS232 – RS232C interface

This menu topic allows you to select the peripheral device connected to the RS232C interface and to specify how the data is transmitted.

- | | |
|----------------|-----------------------------------------------------|
| PRINTER | Connection to a printer. (Factory setting) |
|----------------|-----------------------------------------------------|









Only one printer possible.

Refer to your printer documentation for recommended printer settings.



PRT.STAB

If the  key is pressed, the next stable weight value will be printed. (**Factory setting**)

PRT.AUTO	Every stable weight value will be printed, without pressing the  key.
PRT.ALL	If the  key is pressed, the weight value will be printed regardless of stability.
PC-DIR.	Connection to a PC: the balance can send data (as a Keyboard) to the PC used for PC applications, e.g., Excel. <ul style="list-style-type: none"> • The balance sends the weight value without the unit to the PC. • Not available on Win7.
PRT.STAB	If the  key is pressed, the next stable weight value will be sent followed by an enter. (Factory setting)
PRT.AUTO	Every stable weight value will be sent followed by an enter, without pressing the  key.
PRT.ALL	If the  key is pressed, the weight value will be sent followed by an enter regardless of stability.
HOST	Connection to a PC, barcode reader etc.: the balance can send data to the PC and receive commands or data from the PC. The balance sends the complete MT-SICS answer to the PC, see chapter "MT-SICS interface commands and functions".
SND.OFF	Send mode switched off. (Factory setting)
SND.STB	If the  key is pressed, the next stable weight value will be sent.
SND.CONT	All weight value updates will be sent regardless of stability, without pressing the  key.
SND.AUTO	Every stable weight value will be sent, without pressing the  key.
SND.ALL	If the  key is pressed, the weight value will be sent regardless of stability.
2.DISP	Connection of an optional auxiliary display unit. The transmission parameters cannot be selected. Settings are automatically set.

HEADER – Options for the printout header of individual values

This menu topic allows you to specify the information that is to be printed at the top of the printout for every individual weighing results (after pressing .

Note

This menu topic is only available if **PRINTER** setting was selected.

NO	The header is not be printed. (Factory setting)
DAT/TIM	Date and time are printed.
D/T/BAL	Date, time and balance information (Balance type, SNR, Balance ID) are printed. Balance ID only if set.

SINGLE – Options for printing out the result of individual values

This menu topic allows you to specify the information that is to be printed for every individual weighing result (after pressing .

Note

This menu topic is only available if **PRINTER** setting was selected.

NET	The value of the net weight from the current weighing is printed. (Factory setting)
------------	--------------------------------------------------------------------------------------------

G/T/N

The values of the gross weight, the tare weight and the net weight are printed.

SIGN.L – Options for the printout footer for signature line of individual values

This menu topic allows you to set a footer for signature at the bottom of the printout for every individual weighing result (after pressing .

Note

This menu topic is only available if **PRINTER** setting was selected.

OFF

The signature footer is not be printed. (**Factory setting**)

ON

The signature footer is printed.

LN.FEED – Options for complete the printout of individual values

This menu topic allows you to specify the number of blank lines to complete the printout for every individual weighing result (after pressing .

Note

This menu topic is only available if **PRINTER** setting was selected.

0

Possible numbers of blank lines: 0 to 99. (**Factory setting = 0**)

ZERO.PRT – Options for PRT.AUTO

This menu topic allows you to specify the auto print function **PRT.AUTO** for printing zero **YES** or **NO**.

OFF

Zero is not be printed (Zero +/- 3d). (**Factory setting**)

ON

Zero is always printed.

Note

This menu topic is only available if **PRT.AUTO** function of the **PRINTER** or **PC-DIR**. was selected.

COM.SET – Options for the data communication format (RS232C) (HOST)

This menu topic allows you to set the data format depending on which peripheral device is connected.

Note

This menu topic is only available if **HOST** setting was selected.

MT-SICS

The MT-SICS data transfer formats is used (factory setting).

SART

The following Sartorius commands are supported:

- K Ambient conditions: very stable
- L Ambient conditions: stable
- M Ambient conditions: unstable
- N Ambient conditions: very unstable
- O Block keys
- P Print key (print, auto print; activate or block)
- R Unblock keys
- S Restart/self-test
- T Tare key
- W Adjustment *)
- Z Internal adjustment **)
- f1_ Function key (CAL)
- s3_ C key
- x0_ Perform internal adjustment **)
- x1_ Print balance/scale model

x2_ Print weighing cell serial number

x3_ Print software version

*) May be inaccessible on verified balances/scales

**) Only on models with built-in motorized adjustment weight

Functionality mapping

HOST settings:

SND.OFF

not applicable

SND.STB

manually print with stability

SND.ALL

manually print without stability

SND.CONT

automatically print without stability

SND.AUTO

similar applicable to automatically print when load is changed

BAUD – Baud rate RS232C

This menu topic allows you to match the data transmission to different serial RS232C receivers. The baud rate (data transfer rate) determines the speed of transmission via the serial interface. For problem-free data transmission the sending and receiving devices must be set at the same value.

The following settings are available:

600 bd, 1200 bd, 2400 bd, 4800 bd, **9600 bd (Factory setting)**, 19200 and 38400 bd.

Note

- Not visible for 2nd display.
- Each device has separate settings.

BIT.PAR. – Bit/Parity RS232C

This menu topic allows you to set the character format for the attached RS232C serial peripheral device.

8/NO	8 data bits/no parity (Factory setting)
7/NO	7 data bits/no parity
7/MARK	7 data bits/mark parity
7/SPACE	7 data bits/space parity
7/EVEN	7 data bits/even parity
7/ODD	7 data bits/odd parity

Note

- Not visible for 2nd display.
- Each device has separate settings.

STOPBIT – Stop bits RS232C

This menu topic allows you to set the stop bits of the transmitted data to different RS232C serial receivers.

1 BIT	1 Stop bit (Factory setting)
2 BITS	2 Stop bits

HD.SHK – Handshake RS232C

This menu topic allows you to match the data transmission to different RS232C serial receivers.

XON.XOFF	Software handshake (XON/XOFF) (Factory setting)
RTS.CTS	Hardware handshake (RTS/CTS)
OFF	No handshake

Note

- Not visible for 2nd display.
- Each device has separate settings.

RS.TX.E.O.L. – End of line RS232C

This menu topic allows you to set the end of line character of the outgoing transmitted data to different RS232C serial receivers.

CR LF	Carriage Return followed by Line feed (ASCII-Codes 013 + 010) (Factory setting)
CR	Carriage Return (ASCII-Code 013)
LF	Line feed (ASCII-Code 010)
TAB	Horizontal tab (ASCII-Code 009) (only visible if PC-DIR. is selected)

Note

- Not visible for 2nd display.
- Each device has separate settings.

RS.CHAR – Char set RS232C

This menu topic allows you to set the character set of the transmitted data to different RS232C serial receivers.

IBM.DOS	Char set IBM/DOS (Factory setting)
ANSI.WIN	Char set ANSI/WINDOWS

Note

- Not visible for 2nd display.
- Each device has separate settings.

INTERVL. – Print key simulation

This menu topic allows you to activate a simulation of the  key. **INTERVL.** simulates pressing the print key every x seconds.

Range:	0 to 65535 seconds
0 sec:	Disables the print key simulation

Factory setting: 0 sec



The executed action is according to the configuration of the print key, see interface setting.

6 Applications

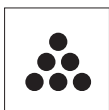
6.1 Application piece counting



The **Piece counting** application allows you to determine the number of pieces put on the weighing pan.

- 1 Press and hold **F** to call-up **APP.LIST**.
- 2 Select application **COUNT** by scrolling with .
- 3 Press  to activate the function.

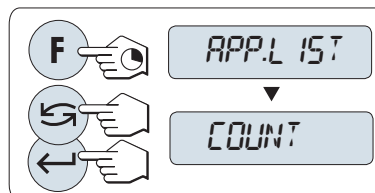



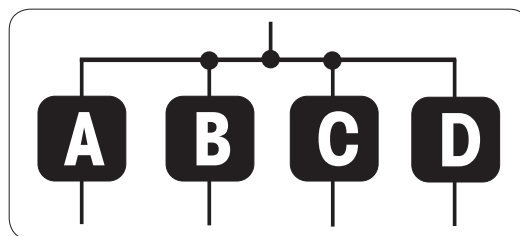

Piece counting first requires the setting of a reference weight, there are 4 possibilities

- **A** Setting the reference **by multiple pieces with fix reference values**.
- **B** Setting the reference **by multiple pieces with variable reference values**.
- **C** Setting the reference **for 1 piece in weighing mode**.
- **D** Setting the reference **for 1 piece in manual mode**.



Setting the reference by multiple pieces with fix reference values



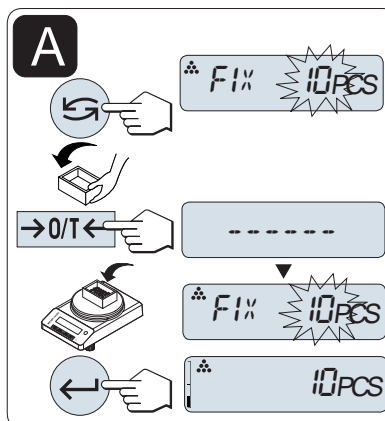





- 1 Select a number of reference pieces by scrolling with . Possible numbers* are 5, 10, 20 and 50.
- 2 Press  to zero the balance. If using: place empty container on the weighing pan and press  to tare the balance.
- 3 Add the selected number of reference pieces to container.
- 4 Press  to confirm.



Approved balances

* with approved balances in selected countries: min 10.

Setting the reference by multiple pieces with variable reference values



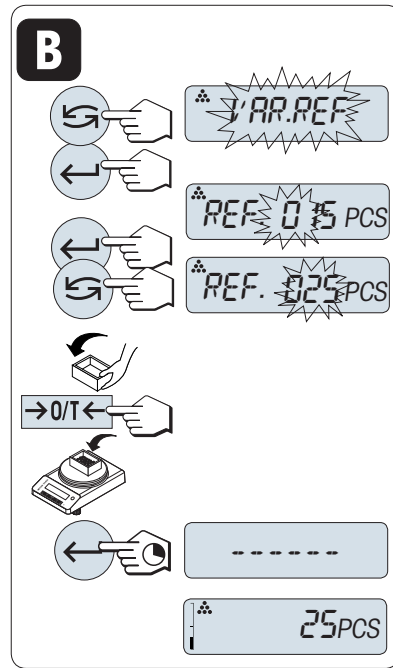



- 1 Select **VAR.REF** by scrolling with .
- 2 Press  to confirm.
- 3 Select the number of reference pieces. Possible numbers* are 1 to 999.
- 4 Press  to select a digit (cyclically from left to right).
➔ The selected digit is blinking.
- 5 Press  to change the digit.
- 6 Press  **0/T**  to zero the balance. If using: place empty container on the weighing pan and press  **0/T**  to tare the balance.
- 7 Add the selected number of reference pieces to container.
- 8 Press and hold  to confirm.



Approved balances

* with approved balances in selected countries: min 10.

Setting the reference for one piece in weighing mode



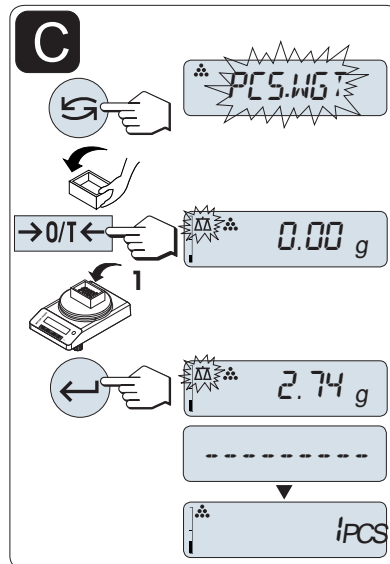

- 1 Select **PCS.WGT** by scrolling with .
- 2 Press  **0/T**  to zero the balance. If using: place empty container on the weighing pan and press  **0/T**  to tare the balance.
- 3 Add one reference piece to container.
➔ The weight of one piece is displayed.
- 4 Press  to confirm.



Approved balances

With approved balances, this setting is not available in selected countries.

Setting the reference for one piece in manual mode

- 1 Select **PCS.WGT** by scrolling with .
- 2 Press  to confirm.
- 3 Enter the final reference one piece weight.
- 4 Press  to select a digit (cyclically from left to right).
→ The selected digit is blinking.
- 5 Press  to change the digit.
- 6 Press and hold  to confirm.

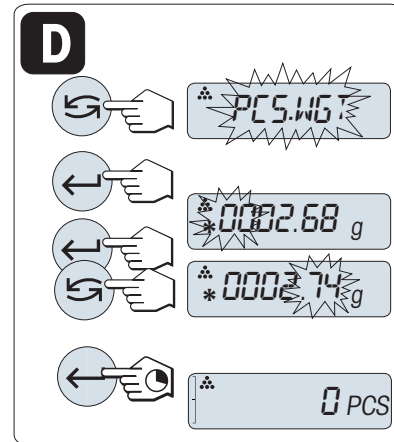

Approved balances

With approved balances, this setting is not available in selected countries.

Note

If without any key press within 60 seconds or by pressing **C**, the balance returns to the previous active application.

On completion of the setting procedure, your balance is ready.

- The **RECALL** value is displayed with an asterisk (*) and icon **M** and can not be printed.
- Take into account minimum values: min. reference weight = 10d (10 digits), min. piece weight* = 1d (1 digit)!
* with approved balances in selected countries: min 3e
- The current reference weight remains stored until the reference setting is changed.



Terminate the application

Press and hold  to terminate the application and to return to the weighing application.

6.2 Application dynamic weighing



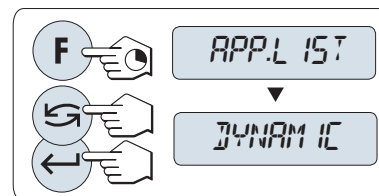

The **Dynamic weighing** application allows you to determine the weights of unstable samples or to determine weights under unstable ambient conditions. The balance calculates the weight as the average of a number of weighing operations over a defined time.

- 1 Press and hold **F** to call-up **APP.LIST**.
- 2 Select application **DYNAMIC** by scrolling with .
- 3 Press  to activate the function.





Setting auto start or manual start

The weighing starts automatically on relative stability. However, the weighing sample must weigh at least 5 grams. For weighing samples below 5 g the weighing must be started manually. Factory setting: **MOD.AUTO** (auto start).

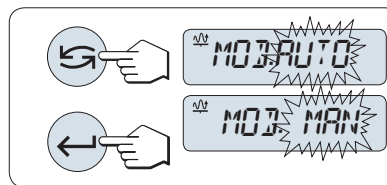
- 1 Press  to select the mode.
- 2 Select **MOD.AUTO** to starts automatically.
or
- 3 Select **MOD. MAN** to starts manually.
- 4 Press  to confirm.







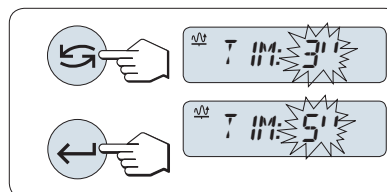





Setting the weighing time

- 1 Press  to select one of the available time intervals: 3 (default value), 5, 10, 20, 60 and 120 seconds.
- 2 Press  to confirm.



Important: If without any key press within 60 seconds, the balance return to the previous active application. Press **C** to cancel and returns to the previous active application.

On completion of the setting procedure, your balance is ready.

- 1 Press  **0/T**  to zero the balance. If using: place empty container on the weighing pan and press  **0/T**  to tare the balance.
- 2 Load sample weight.
- 3 If you have selected function **M.START**, press  to start the weighing.
or
- 4 If you have selected function **A.START**, the weighing starts automatically on relative stability. For weighing samples below 5 g the weighing must be started manually by pressing .
- 5 Read the result.
 - ➔ The result of the dynamic weighing is displayed with an asterisk (* = calculated value).
- 6 Unload sample weight.
- 7 **Manual Start** only, press  **0/T**  to zero the balance and go back to **M.START**.
 - The remaining weighing time (in seconds) is displayed continuously. You can cancel the countdown by pressing **C**.
 - The weight value remains in the display until the sample weight is removed from weighing pan (auto start only) or  **0/T**  is pressed.

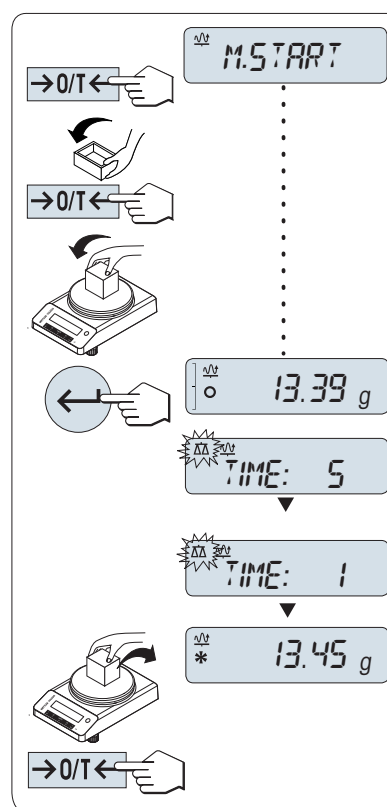

Terminate the application

Press and hold  to terminate the application and to return to the weighing application.

7 Communication with Peripheral Devices

7.1 PC-Direct function

The PC-Direct function of the balance allows you to transfer weight values from the balance to a Windows application. The weight value displayed on the balance is transferred to the cursor position in, e.g., Excel or Word.

The weight value is transferred without the unit.

Requirements

- PC with one of the following Microsoft Windows® 32-bit/64-bit operating systems: Win 7 (SP1), Win 8, Win 10, or Win 11
- Serial interface RS232C or USB
- Administrator rights for installing the SerialPortToKeyboard software (if data transfer is via RS232C)
- Windows application (e.g., Excel)
- Connection between balance and PC via cable

Installing SerialPortToKeyboard software

The operation of PC-Direct via serial port RS232C requires the installation of **SerialPortToKeyboard** on your host computer. The file **SerialPortToKeyboard** can be found on ► www.mt.com/labweighing-software-download. If you have any questions, please contact a METTLER TOLEDO representative.

Download SerialPortToKeyboard

- 1 Connect to the internet.
- 2 Go to the site www.mt.com/labweighing-software-download.
- 3 Click **Download Software and Instructions** in section **SerialPortToKeyboard software for Advanced and Standard level laboratory balances**.
 - ➔ A pop-up window with interactions appears.
- 4 Click, e.g., **Open**.
 - ➔ The extract screen appears.
- 5 Extract the file **SerialPortToKeyboard_V_x.xx_installer_and_instructions.zip** to your specified location.
- 6 Right-click on the downloaded installation program **SerialPortToKeyboard_V_x.xx.exe** and select **Run as Administrator**.
- 7 If a safety warning appears, confirm windows to perform the installation.
- 8 Click **Next** and follow the installer's instructions.

Checking operation

- 1 Start **SerialPortToKeyboard** (RS232)
- 2 Start Excel (or another application) on the computer.
- 3 Activate a cell in Excel.

Settings on the PC

Settings for SerialPortToKeyboard

- 1 Select the serial port **COM** for the connection with the balance.
- 2 Set the **Baud Rate** to **9600**.
- 3 Activate **Connect**.
 - Closing the window terminates the session.

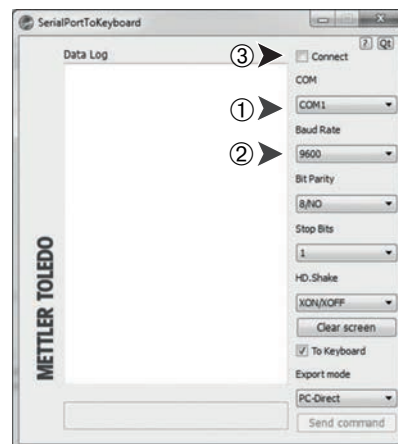

Settings at the balance

Balance interface settings, **see** "Interface menu".

- Topic **RS232** or **USB**: set **PC-DIR.** and select the most appropriate option for the desired weighing result.
- Topic **RS.TX.E.O.L./RS E.O.L.** or **USB E.O.L./USB E.O.L.**:
 - set **<TAB>** to write into the same row (e.g. in Excel).
 - set **<CR><LF>** to write into the same column (e.g. in Excel).
- Save changes.

According to your selected **PC-DIR.** option, the displayed values will appear e.g. in the column one after the other one in the different rows.

8 Maintenance

To guarantee the functionality of the balance and the accuracy of the weighing results, a number of maintenance actions must be performed by the user.

8.1 Maintenance tasks

Maintenance action	Recommended interval	Remarks
Performing an adjustment	<ul style="list-style-type: none">• Daily• After cleaning• After leveling• After changing the location	see "Adjusting the balance"
Performing routine tests (sensitivity test, repeatability test). METTLER TOLEDO recommends to perform at least a sensitivity test.	<ul style="list-style-type: none">• After cleaning	see "Performing routine tests"
Cleaning	Depending on the degree of pollution or your internal regulations (SOP), clean the instrument: <ul style="list-style-type: none">• After every use• After change of sample	see "Cleaning the balance"

See also

 [Adjusting the balance](#) ▶ Page 17

 [Performing routine tests](#) ▶ Page 38

 [Cleaning the balance](#) ▶ Page 39

8.2 Performing routine tests

There are several routine tests. Depending on your internal regulations, specific routine test must be performed by the user.

METTLER TOLEDO recommends to perform an sensitivity test after cleaning and reassembling the balance.

8.3 Cleaning

8.3.1 Cleaning the glass draft shield



CAUTION

Injury due to breaking glass

Careless handling of the glass components can lead to breakage off glass and damage cuttings.

- Always proceed focused and with care.

Removing or inserting sliding glass doors

It is possible to remove the sliding glass doors for cleaning or for replacing.

Note

Front and rear glass panels cannot be removed.

- 1 Remove the handle first.
- 2 Remove the sliding glass doors.
- 3 Install the handle after insertion of the glass door.

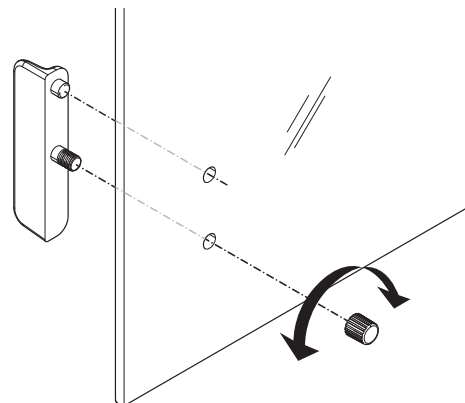

8.3.2 Cleaning the balance



NOTICE

Damage to the instrument due to inappropriate cleaning methods

If liquid enters the housing, it can damage the instrument. The surface of the instrument can be damaged by certain cleaning agents, solvents, or abrasives.

- 1 Do not spray or pour liquid on the instrument.
- 2 Only use the cleaning agents specified in the Reference Manual (RM) of the instrument or the guide "8 Steps to a Clean Balance".
- 3 Only use a lightly moistened, lint-free cloth or a tissue to clean the instrument.
- 4 Wipe off any spills immediately.



For further information on cleaning a balance, consult "8 Steps to a Clean Balance".

www.mt.com/lab-cleaning-guide

Cleaning around the balance

- Remove any dirt or dust around the balance and avoid further contaminations.

Cleaning the terminal

- Clean the terminal with a damp cloth or a tissue and a mild cleaning agent.

Cleaning the removable parts



- Clean the removed part with a damp cloth or a tissue and a mild cleaning agent.

Cleaning the balance

- 1 Disconnect the balance from the AC/DC adapter.
- 2 Use a lint-free cloth moistened with a mild cleaning agent to clean the surface of the balance.
- 3 Remove powder or dust with a disposable tissue first.
- 4 Remove sticky substances with a damp lint-free cloth and a mild solvent, e.g., isopropanol or ethanol 70%.

8.3.3 Putting into operation after cleaning

- 1 Reassemble the balance.

- 2 Check the functionality of the draft shield if applicable.
 - 3 Press  to switch on the balance.
 - 4 Warm up the balance. Wait 1 h for the acclimatization, before starting the tests.
 - 5 Check the level status, level the balance if necessary.
 - 6 Perform an adjustment.
 - 7 Perform a routine test due to the internal regulations of your company. METTLER TOLEDO recommends to perform a repeatability test after cleaning the balance.
 - 8 Press  to zero the balance.
- ➔ The balance has been put into operation and is ready to use.

See also

-  [Leveling the balance ▶ Page 14](#)
-  [Technical Data ▶ Page 46](#)

9 Troubleshooting

Possible errors with their cause and remedy are described in the following chapter. If there are errors that cannot be corrected through these instructions, contact METTLER TOLEDO.

9.1 Error messages

Error message	Possible cause	Diagnostic	Remedy
NO STABILITY	Vibrations at the workplace.	Place beaker with tap water on the weighing table. Vibrations cause ripples on the water surface.	<ul style="list-style-type: none"> Protect weighing location against vibrations (vibration absorber, etc.). Set weighing parameters coarser (change ENVIRON. from STABLE to STANDARD or even UNSTABLE). Find a different weighing location.
	Draft due to untight draft shield and /or open window.	Make sure draft shield or window is closed.	<ul style="list-style-type: none"> Close draft shield or window. Set weighing parameters coarser (change ENVIRON. from STABLE to STANDARD or even UNSTABLE).
	The location is not suitable for weighing.	–	Check and observe the requirements for the location, refer to "Selecting the location".
	Something is touching the weighing pan.	Check for touching parts or dirt.	Remove touching parts or clean the balance.
WRONG ADJUSTMENT WEIGHT	Wrong adjustment weight.	Check weight.	Place correct weight on the weighing pan.
REFERENCE TOO SMALL	Reference for piece counting too small.	–	Increase reference weight.
EEPROM ERROR - PLEASE CONTACT CUSTOMER SERVICE	Data in EEPROM damaged.	–	Please contact your METTLER TOLEDO customer service.
WRONG CELL DATA - PLEASE CONTACT CUSTOMER SERVICE	Defect load cell data.	–	Please contact your METTLER TOLEDO customer service.
NO STANDARD ADJUSTMENT - PLEASE CONTACT CUSTOMER SERVICE	–	–	Please contact your METTLER TOLEDO customer service.
PROGRAM MEMORY DEFECT - PLEASE CONTACT CUSTOMER SERVICE	–	–	Please contact your METTLER TOLEDO customer service.

Error message	Possible cause	Diagnostic	Remedy
TEMP SENSOR DEFECT - PLEASE CONTACT CUSTOMER SERVICE	AC/DC adapter connected to power before connecting to the balance. Temperature sensor of load cell defect.	–	Remove the AC/DC adapter from the power and connect first to the balance before connecting to the power if persist please contact your METTLER TOLEDO customer service.
WRONG LOAD CELL BRAND - PLEASE CONTACT CUSTOMER SERVICE	Wrong load cell installed.	–	Please contact your METTLER TOLEDO customer service.
WRONG TYPE DATA SET - PLEASE CONTACT CUSTOMER SERVICE	Wrong type data set.	–	Please contact your METTLER TOLEDO customer service.
BATTERY BACKUP LOST - CHECK DATE TIME SETTINGS	Backup battery/capacitor is empty. This battery/capacitor ensures that the date and time are not lost when the balance is disconnected from power.	The battery/capacitor provides enough power for approximately 2 days when having the balance not connected to the power supply.	Connect the balance to the power supply for charging the battery (e.g., during the night) or contact METTLER TOLEDO customer service.
ABOVE INITIAL ZERO RANGE	Wrong weighing pan. Pan is not empty.	Check weighing pan.	Mount correct weighing pan or unload weighing pan.
BELOW INITIAL ZERO RANGE	Wrong weighing pan. Pan is missing.	Check weighing pan.	Mount correct weighing pan.
MEM FULL	Memory full.	–	Clear the memory by finishing all applications where a measurement is ongoing.
FACTOR OUT OF RANGE	Factor is outside the allow range.	–	Select a new factor.
STEP OUT OF RANGE	Step is outside the allow range.	–	Select a new step.
OUT OF RANGE	Sample weight is outside the allow range.	–	Unload the pan and load a new sample weight.

9.2 Error symptoms

Error symptom	Possible cause	Diagnostic	Remedy
Display is dark	Instrument is switched off.	–	Switch on the instrument.
	Power plug not connected.	Check	Connect power cable to power supply.
	Power supply not connected to balance.	Check	Connect power supply.
	Power supply is faulty.	Check/test	Replace power supply.
	Wrong power supply.	Check that input data on type plate match the power supply values.	Use proper power supply.
	Connector socket on balance is corroded or faulty.	Check	Please contact your METTLER TOLEDO customer service.

Error symptom	Possible cause	Diagnostic	Remedy
	Display is faulty.	Replace display.	Please contact your METTLER TOLEDO customer service.
Operation Keys do not work	Keypad is defective.	–	Please contact your METTLER TOLEDO customer service.
The value drifts into plus or minus	Room, environment not suitable.	–	Environmental recommendations <ul style="list-style-type: none"> • Windowless, non air-conditioned room, e.g., basement. • Only one person in the weighing room. • Sliding doors. Standard doors cause pressure changes. • No draft in weighing room (check with suspended threads). • No air conditioning (temperature oscillates, draft). • Acclimatize balance, take dummy measurements. • Instrument uninterruptedly connected to the power supply (24h per day).
	Direct sunlight or other heat source.	Is any sun shade (blinds, curtains, etc.) available?	Select location according to "Selecting the location" (customer responsibility).
	Weighing sample absorbs moisture or evaporates moisture.	<ul style="list-style-type: none"> • Is the weighing result with a test weight stable? • Sensitive weighing samples, e.g., paper, cardboard, wood, plastic, rubber, liquids. 	<ul style="list-style-type: none"> • Use aids. • Cover weighing sample.
	Weighing sample is electrostatically charged.	<ul style="list-style-type: none"> • Is the weighing result with a test weight stable? • Sensitive weighing samples, e.g., plastic, powder, insulating materials. 	<ul style="list-style-type: none"> • Increase air humidity in weighing chamber (45% - 50%). • Use ionizer.
	Weighing sample is hotter or colder than the air in the weighing chamber.	Weighing operation with test weight does not show this effect.	Bring weighing sample to room temperature before weighing.

Error symptom	Possible cause	Diagnostic	Remedy
	Instrument has not yet reached thermal equilibrium.	<ul style="list-style-type: none"> Was there a power outage? Was power supply disconnected? 	<ul style="list-style-type: none"> Acclimatize instrument for at least 1 hour. Depending on climatic conditions, extend this period accordingly. Instrument switched on for at least 1 hour, refer to "General data"
Display shows overload or underload	The weight on the weighing pan exceeds the weighing capacity of the instrument.	Check weight.	Reduce the weight on the weighing pan.
	Wrong weighing pan.	Slightly lift or press weighing pan. The weight display appears.	Use proper weighing pan.
	No weighing pan.	–	Install weighing pan.
	Incorrect zero point at switch-on.	–	<ul style="list-style-type: none"> Switch off balance. Disconnect and reconnect power cable.
Display flashes 0.0000	Loose cables.	Check all cable connections.	Connect all cables. Please contact your METTLER TOLEDO customer service if the problem persists.
Taring not possible	Vibrations at the workplace.	Display unstable.	Press Tare again.
		Place beaker with tap water on the weighing table. Vibrations cause ripples on the water surface.	<ul style="list-style-type: none"> Protect weighing location against vibrations (vibration absorber, etc.). Set weighing parameters coarser (change ENVIRON. from STABLE to STANDARD or even UNSTABLE). Find a different weighing location (by agreement with customer).

9.3 Putting into operation after troubleshooting

After troubleshooting, perform the following steps to put the balance into operation:

- Ensure that the balance is completely reassembled and cleaned.
- Reconnect the balance to the AC/DC adapter.

10 Technical Data

10.1 General data

Standard power supply

AC/DC adapter:

Input: 100 – 240 V AC \pm 10%, 50 – 60 Hz, 0.5 A, 24 – 34 VA

Output: 12 V DC, 1.0 A, LPS

Polarity:



Balance power consumption:

12 V DC, 0.3 A

If the balance is used above 2000 m mean sea level, the optional power supply must be used.

Optional power supply

AC/DC adapter:

Input: 100 – 240 V AC \pm 10%, 50 – 60 Hz, 0.8 A, 61 – 80 VA

Output: 12 V DC, 2.5 A, LPS

Cable for AC/DC adapter:

3-core, with country-specific plug

Polarity:



Balance power consumption:

12 V DC, 0.3 A

Protection and standards

Overvoltage category:

II

Degree of pollution:

2

Standards for safety and EMC:

See Declaration of Conformity

Range of application:

Use only indoors in dry locations

Environmental conditions

Height above mean sea level:

Up to 2000 m (standard power supply)

Up to 5000 m (optional power supply)

Ambient temperature:

+5 °C – +40 °C

Storage condition:

-25 °C – +70 °C

Relative air humidity:

Max. 80% up to 31 °C, linearly decreasing to 50% at 40 °C, non-condensing

Warm-up time:

At least **30** minutes (0.1 mg models **60** minutes) after connecting the balance to the power supply.

Materials

Housing:

Top Housing: ABS

Bottom housing: Die-cast aluminum, lacquered

Weighing pan:

Ø 80 mm: Stainless steel X2CrNiMo 17-12-2 (1.4404)

All others: Stainless steel X5CrNi 18-10 (1.4301)

Draft shield element:

0.1 mg models: Stainless steel X5CrNi 18-10 (1.4301)

Draft shield:

ABS, glass

Protective cover:

PET

Backup battery:

Capacitor (saves date and time for approximately two days)

10.2 Model-specific data

10.2.1 Balances with readability of 0.1 mg

	LA84	LA104	LA204
Limit values			
Capacity	82 g	120 g	220 g
Nominal load	80 g	100 g	200 g
Readability	0.1 mg	0.1 mg	0.1 mg
Repeatability (at 5% load)	0.1 mg	0.1 mg	0.1 mg
Linearity deviation	0.2 mg	0.2 mg	0.2 mg
Eccentricity deviation (at test load)	0.4 mg (50 g)	0.4 mg (50 g)	0.4 mg (100 g)
Sensitivity offset (at nominal load) ▲	0.5 mg	0.5 mg	0.8 mg
Sensitivity temperature drift	0.0003%/°C	0.0003%/°C	0.0003%/°C
Typical values			
Repeatability (at 5% load)	0.08 mg	0.08 mg	0.08 mg
Linearity deviation	0.08 mg	0.08 mg	0.08 mg
Eccentricity deviation (at test load)	0.12 mg (50 g)	0.12 mg (50 g)	0.12 mg (100 g)
Sensitivity offset (at nominal load) ▲	0.3 mg	0.3 mg	0.5 mg
Minimum weight (USP, tolerance = 0.10%) ▼	160 mg	160 mg	160 mg
Minimum weight (tolerance = 1%) ▼	16 mg	16 mg	16 mg
Settling time	3 s	3 s	3 s
Dimensions and other specifications			
Balance dimensions (W × D × H)	210 × 308 × 345 mm	210 × 308 × 345 mm	210 × 308 × 345 mm
Weighing pan diameter	80 mm	80 mm	80 mm
Usable height of draft shield	236.5 mm	236.5 mm	236.5 mm
Balance weight	5 kg	5 kg	5 kg
Weights for routine testing			
Weights (OIML class)	50 g (F2) / 2 g (F2)	100 g (F2) / 5 g (F2)	200 g (F2) / 10 g (F2)
Weights (ASTM class)	50 g (ASTM 1) / 2 g (ASTM 1)	100 g (ASTM 1) / 5 g (ASTM 1)	200 g (ASTM 1) / 10 g (ASTM 1)

▲ after adjustment with internal weight

▼ determined at 5% load, k = 2

	LA84E	LA104E	LA204E
Limit values			
Capacity	82 g	120 g	220 g
Nominal load	80 g	100 g	200 g
Readability	0.1 mg	0.1 mg	0.1 mg
Repeatability (at 5% load)	0.1 mg	0.1 mg	0.1 mg
Linearity deviation	0.2 mg	0.2 mg	0.2 mg
Eccentricity deviation (at test load)	0.4 mg (50 g)	0.4 mg (50 g)	0.4 mg (100 g)
Sensitivity offset (at nominal load) ▲	0.5 mg	0.5 mg	0.8 mg
Sensitivity temperature drift	0.0003%/°C	0.0003%/°C	0.0003%/°C
Typical values			
Repeatability (at 5% load)	0.08 mg	0.08 mg	0.08 mg
Linearity deviation	0.08 mg	0.08 mg	0.08 mg
Eccentricity deviation (at test load)	0.12 mg (50 g)	0.12 mg (50 g)	0.12 mg (100 g)
Minimum weight (USP, tolerance = 0.10%) ▼	160 mg	160 mg	160 mg
Minimum weight (tolerance = 1%) ▼	16 mg	16 mg	16 mg
Settling time	3 s	3 s	3 s
Dimensions and other specifications			
Balance dimensions (W × D × H)	210 × 308 × 345 mm	210 × 308 × 345 mm	210 × 308 × 345 mm
Weighing pan diameter	80 mm	80 mm	80 mm
Usable height of draft shield	236.5 mm	236.5 mm	236.5 mm
Balance weight	4.8 kg	4.8 kg	4.8 kg
Weights for routine testing			
Weights (OIML class)	50 g (F2) / 2 g (F2)	100 g (F2) / 5 g (F2)	200 g (F2) / 10 g (F2)
Weights (ASTM class)	50 g (ASTM 1) / 2 g (ASTM 1)	100 g (ASTM 1) / 5 g (ASTM 1)	200 g (ASTM 1) / 10 g (ASTM 1)

▲ after adjustment

▼ determined at 5% load, k = 2

10.2.2 Balances with readability of 1 mg

	LA203	LA403
Limit values		
Capacity	220 g	420 g
Nominal load	200 g	400 g
Readability	1 mg	1 mg
Repeatability (at 5% load)	1 mg	1 mg
Linearity deviation	2 mg	2 mg
Eccentricity deviation (at test load)	4 mg (100 g)	4 mg (200 g)
Sensitivity offset (at nominal load) ▲	8 mg	8 mg
Sensitivity temperature drift	0.0004%/°C	0.0004%/°C
Typical values		
Repeatability (at 5% load)	0.7 mg	0.7 mg
Linearity deviation	0.6 mg	0.6 mg
Eccentricity deviation (at test load)	1.5 mg (100 g)	1.5 mg (200 g)
Sensitivity offset (at nominal load) ▲	5 mg	5 mg
Minimum weight (USP, tolerance = 0.10%) ▼	1.4 g	1.4 g
Minimum weight (tolerance = 1%) ▼	0.14 g	0.14 g
Settling time	3 s	3 s
Dimensions and other specifications		
Balance dimensions (W × D × H)	210 × 308 × 280 mm	210 × 308 × 280 mm
Weighing pan diameter	100 mm	100 mm
Usable height of draft shield	169 mm	169 mm
Balance weight	4.5 kg	4.5 kg
Weights for routine testing		
Weights (OIML class)	200 g (F2) / 10 g (F2)	200 g (F2) / 20 g (F2)
Weights (ASTM class)	200 g (ASTM 1) / 10 g (ASTM 1)	200 g (ASTM 1) / 20 g (ASTM 1)

▲ after adjustment with internal weight

▼ determined at 5% load, k = 2

	LA203E	LA403E
Limit values		
Capacity	220 g	420 g
Nominal load	200 g	400 g
Readability	1 mg	1 mg
Repeatability (at 5% load)	1 mg	1 mg
Linearity deviation	2 mg	2 mg
Eccentricity deviation (at test load)	4 mg (100 g)	4 mg (200 g)
Sensitivity offset (at nominal load) ▲	8 mg	8 mg
Sensitivity temperature drift	0.0004%/°C	0.0004%/°C
Typical values		
Repeatability (at 5% load)	0.7 mg	0.7 mg
Linearity deviation	0.6 mg	0.6 mg
Eccentricity deviation (at test load)	1.5 mg (100 g)	1.5 mg (200 g)
Minimum weight (USP, tolerance = 0.10%) ▼	1.4 g	1.4 g
Minimum weight (tolerance = 1%) ▼	0.14 g	0.14 g
Settling time	3 s	3 s
Dimensions and other specifications		
Balance dimensions (W × D × H)	210 × 308 × 280 mm	210 × 308 × 280 mm
Weighing pan diameter	100 mm	100 mm
Usable height of draft shield	169 mm	169 mm
Balance weight	4.3 kg	4.3 kg
Weights for routine testing		
Weights (OIML class)	200 g (F2) / 10 g (F2)	200 g (F2) / 20 g (F2)
Weights (ASTM class)	200 g (ASTM 1) / 10 g (ASTM 1)	200 g (ASTM 1) / 20 g (ASTM 1)

▲ after adjustment

▼ determined at 5% load, k = 2

10.2.3 Balances with readability of 10 mg

	LA2002	LA4002
Limit values		
Capacity	2200 g	4200 g
Nominal load	2000 g	4000 g
Readability	10 mg	10 mg
Repeatability (at 5% load)	10 mg	10 mg
Linearity deviation	20 mg	20 mg
Eccentricity deviation (at test load)	40 mg (1000 g)	40 mg (2000 g)
Sensitivity offset (at nominal load) ▲	80 mg	80 mg
Sensitivity temperature drift	0.0004%/°C	0.0004%/°C
Typical values		
Repeatability (at 5% load)	7 mg	7 mg
Linearity deviation	6 mg	6 mg
Eccentricity deviation (at test load)	12 mg (1000 g)	12 mg (2000 g)
Sensitivity offset (at nominal load) ▲	50 mg	50 mg
Minimum weight (USP, tolerance = 0.10%) ▼	14 g	14 g
Minimum weight (tolerance = 1%) ▼	1.4 g	1.4 g
Settling time	3 s	3 s
Dimensions and other specifications		
Balance dimensions (W × D × H)	200 × 308 × 102 mm	200 × 308 × 102 mm
Weighing pan diameter	180 mm	180 mm
Balance weight	3.3 kg	3.3 kg
Weights for routine testing		
Weights (OIML class)	2 kg (F2) / 100 g (F2)	2 kg (F2) / 200 g (F2)
Weights (ASTM class)	2 kg (ASTM 1) / 100 g (ASTM 1)	2 kg (ASTM 4) / 200 g (ASTM 4)

▲ after adjustment with internal weight

▼ determined at 5% load, k = 2

	LA2002E	LA4002E
Limit values		
Capacity	2200 g	4200 g
Nominal load	2000 g	4000 g
Readability	0.01 g	0.01 g
Repeatability (at 5% load)	10 mg	10 mg
Linearity deviation	20 mg	20 mg
Eccentricity deviation (at test load)	40 mg (1000 g)	40 mg (2000 g)
Sensitivity offset (at nominal load) ▲	80 mg	80 mg
Sensitivity temperature drift	0.0004%/°C	0.0004%/°C
Typical values		
Repeatability (at 5% load)	7 mg	7 mg
Linearity deviation	6 mg	6 mg
Eccentricity deviation (at test load)	12 mg (1000 g)	12 mg (2000 g)
Minimum weight (USP, tolerance = 0.10%) ▼	14 g	14 g
Minimum weight (tolerance = 1%) ▼	1.4 g	1.4 g
Settling time	3 s	3 s
Dimensions and other specifications		
Balance dimensions (W × D × H)	200 × 308 × 102 mm	200 × 308 × 102 mm
Weighing pan diameter	180 mm	180 mm
Balance weight	3.1 kg	3.1 kg
Weights for routine testing		
Weights (OIML class)	2 kg (F2) / 100 g (F2)	2 kg (F2) / 200 g (F2)
Weights (ASTM class)	2 kg (ASTM 1) / 100 g (ASTM 1)	2 kg (ASTM 4) / 200 g (ASTM 4)

▲ after adjustment

▼ determined at 5% load, k = 2

10.3 Dimensions

10.3.1 Balances with readability of 0.1 mg

Dimensions in mm.

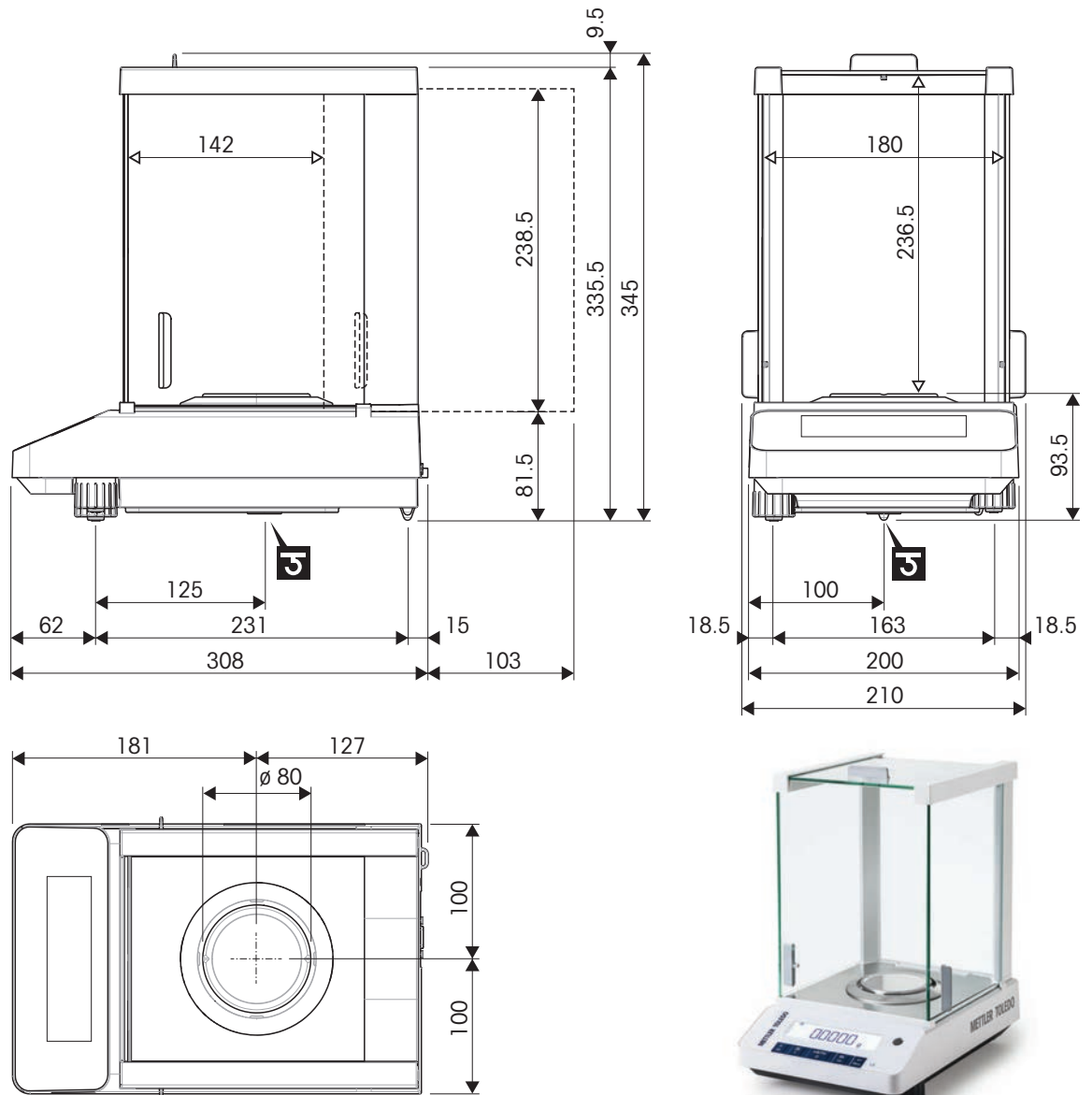

	Outer dimensions [mm]
	Clear dimensions [mm]
	Position of the weighing hook axle

10.3.2 Balances with readability of 1 mg

Dimensions in mm.

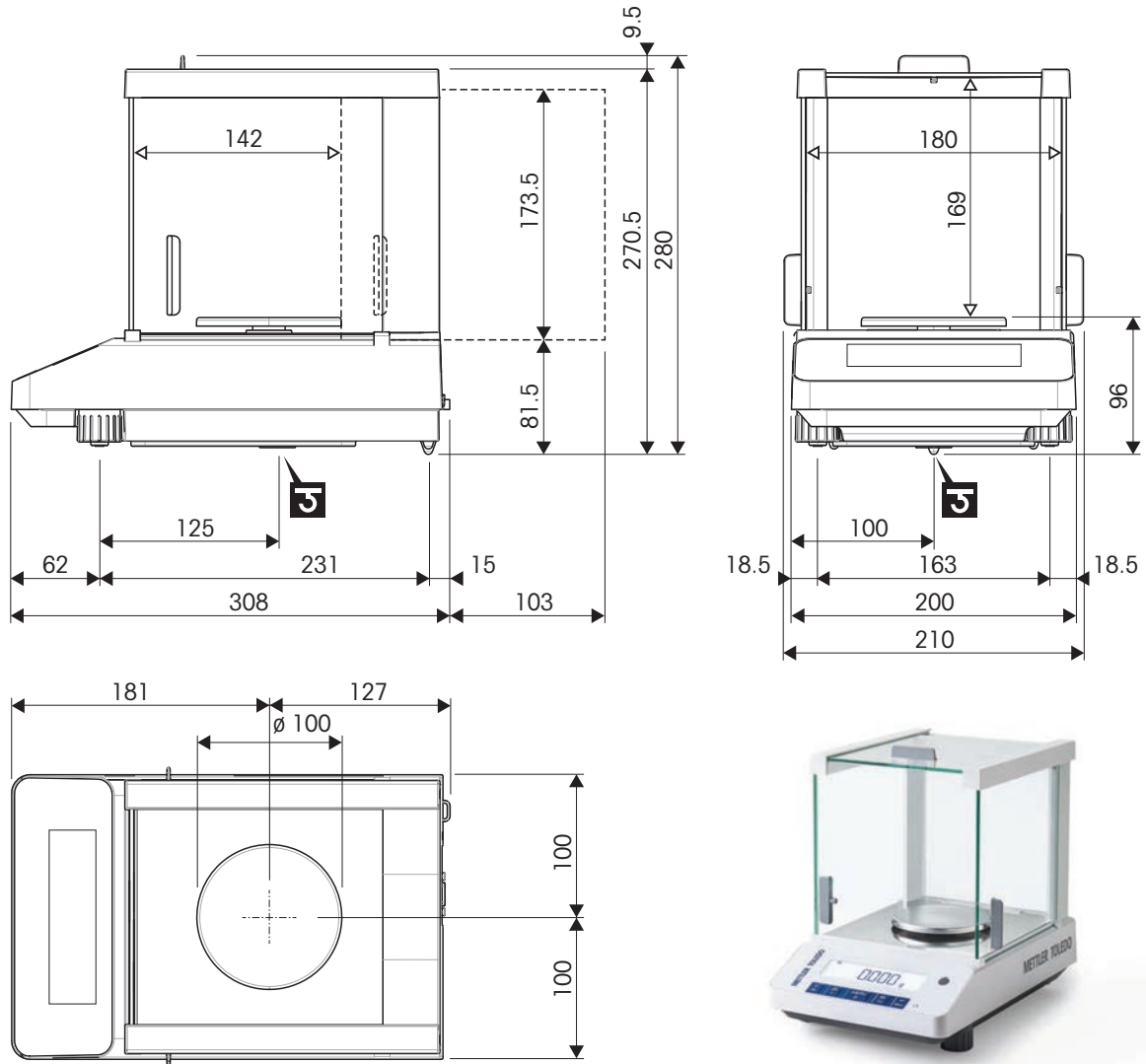

↔	Outer dimensions [mm]
◁ ▷	Clear dimensions [mm]
	Position of the weighing hook axle

10.3.3 Balances with readability of 10 mg

Dimensions in mm.

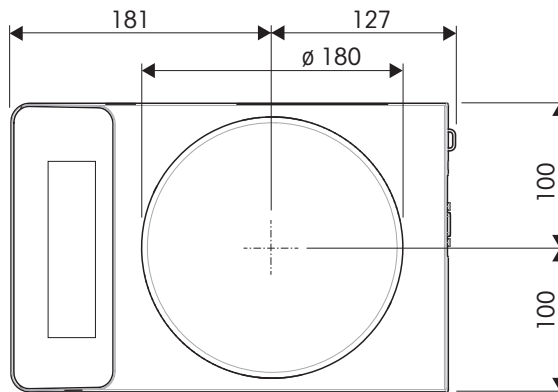
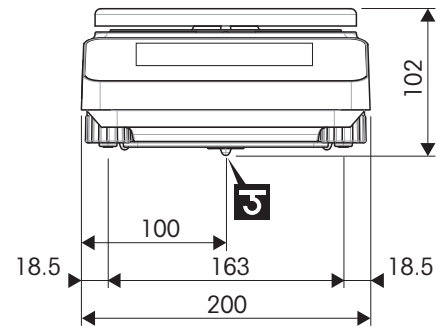
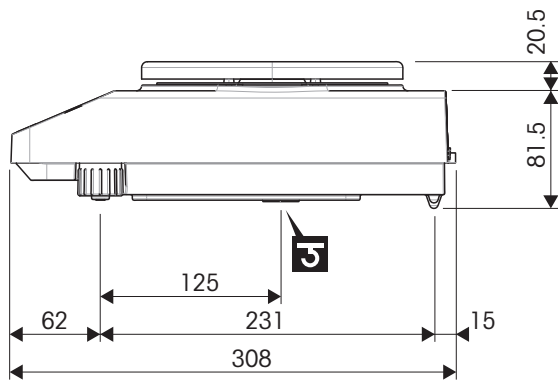

↔	Outer dimensions [mm]
⇄	Clear dimensions [mm]
J	Position of the weighing hook axle

10.4 Interface specification

10.4.1 RS232C interface

Each balance is equipped with a RS232C Interface as standard for the attachment of a peripheral device, e.g., a printer or a computer.

Schematic	Item	Specification
	Interface type	Voltage interface according to EIA RS232C/ DIN66020 CCITT V24/V.28)
	Max. cable length	15 m
	Signal level	Outputs: +5 V ... +15 V (RL = 3–7 kΩ) –5 V ... –15 V (RL = 3–7 kΩ) Inputs: +3 V ... +25 V –3 V ... –25 V
	Connector	Sub-D, 9-pole, female
	Operating mode	Full duplex
	Transmission mode	Bit-serial, asynchronous
	Transmission code	ASCII
	Baud rates	600, 1200, 2400, 4800, 9600, 19200, 38400 (software selectable)
	Bits/parity	7-bit/none, 7-bit/even, 7-bit/odd, 8-bit/none (software selectable)
	Stop bits	1 stop bit
	Handshake	None, XON/XOFF, RTS/CTS (software selectable)
	End-of-line	<CR><LF>, <CR>, <LF> (software selectable)
	Power supply for 2nd display	+ 12 V, max 40 mA (software selectable, 2nd display mode only)

10.4.2 MT-SICS interface commands and functions

Many of the instruments and balances used have to be able to integrate into a complex computer or data acquisition system.

To easily integrate a balance into a system and utilize its capacity to the full extent, most balance functions are also available as corresponding commands via the data interface.

All new METTLER TOLEDO balances launched on the market support "METTLER TOLEDO Standard Interface Command Set" (MT-SICS). The commands available depend on the functionality of the balance.

For further information, please contact your METTLER TOLEDO representative.



Refer to the MT-SICS Reference Manual.

► www.mt.com/library

11 Accessories and Spare Parts

11.1 Accessories

Printers



Printer RS-P25

30702967

- Printing technology: dot matrix

Cables for RS232C interfaces



Cable RS9 (m) – RS9 (f)

11101051

- Data transfer between instrument and peripheral
- Length: 1 m



Cable RS25 (f) – RS9 (m)

11101052

- Data transfer between instrument and peripheral
- Length: 2 m



Cable RS232 (m) – USB-A (m)

64088427

- Data transfer between balance and peripheral
- Length: 2 m

Wireless interfaces



Bluetooth adapter ADP-BT-P, set

30086495

- Creates a bluetooth connection between instrument and peripheral

Software



EasyDirect Balance

EasyDirect Balance, 3 licenses

30539323

- Data management software for up to 3 balances
- Collection, analysis, storage and export of weighing data









EasyDirect Balance

EasyDirect Balance, 10 licenses

30540473

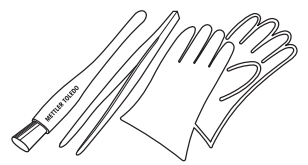
- Data management software for up to 10 balances
- Collection, analysis, storage and export of weighing data

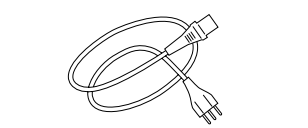
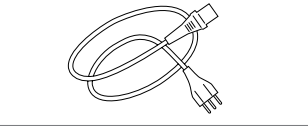
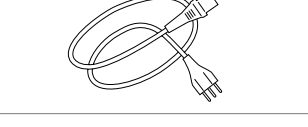
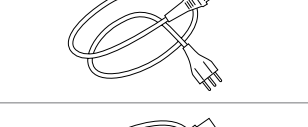
Various

	<p>Auxiliary display AD-RS-M7</p> <ul style="list-style-type: none"> • Duplicates the information of the balance display • Interface: RS232 	<p>12122381</p>
	<p>Anti-theft cable</p>	<p>11600361</p>
	<p>Weights</p> <ul style="list-style-type: none"> • For routine testing and calibration of weighing instruments • Available in different accuracy classes • With calibration certificate (OIML/ASTM) <p>► www.mt.com/weights</p>	
	<p>ToolKitBox</p> <ul style="list-style-type: none"> • Including: brush, tweezers, gloves 	<p>30046403</p>
	<p>AC/DC adapter</p> <ul style="list-style-type: none"> • Converts alternating current (AC) to direct current (DC) • Order country specific power cable separately 	<p>11107909</p>
	<p>Power cable AU</p> <ul style="list-style-type: none"> • 3-pin power cable, with grounding conductor • Length: 2 m 	<p>88751</p>
	<p>Power cable BR</p> <ul style="list-style-type: none"> • 3-pin power cable, with grounding conductor • Length: 2 m 	<p>30015268</p>
	<p>Power cable CH</p> <ul style="list-style-type: none"> • 3-pin power cable, with grounding conductor • Length: 2 m 	<p>87920</p>
	<p>Power cable CN</p> <ul style="list-style-type: none"> • 3-pin power cable, with grounding conductor • Length: 2 m 	<p>30047293</p>
	<p>Power cable DK</p> <ul style="list-style-type: none"> • 3-pin power cable, with grounding conductor • Length: 2 m 	<p>87452</p>

	<p>Power cable EU</p> <ul style="list-style-type: none"> • 3-pin power cable, with grounding conductor • Length: 2 m 	87925
	<p>Power cable GB</p> <ul style="list-style-type: none"> • 3-pin power cable, with grounding conductor • Length: 2 m 	89405
	<p>Power cable IL</p> <ul style="list-style-type: none"> • 3-pin power cable, with grounding conductor • Length: 2 m 	225297
	<p>Power cable IN</p> <ul style="list-style-type: none"> • 3-pin power cable, with grounding conductor • Length: 2 m 	11600569
	<p>Power cable IT</p> <ul style="list-style-type: none"> • 3-pin power cable, with grounding conductor • Length: 2 m 	87457
	<p>Power cable JP</p> <ul style="list-style-type: none"> • 3-pin power cable, with grounding conductor • Length: 2 m 	11107881
	<p>Power cable TH, PE</p> <ul style="list-style-type: none"> • 3-pin power cable, with grounding conductor • Length: 2 m 	11107880
	<p>Power cable US</p> <ul style="list-style-type: none"> • 3-pin power cable, with grounding conductor • Length: 2 m 	88668
	<p>Power cable ZA</p> <ul style="list-style-type: none"> • 3-pin power cable, with grounding conductor • Length: 2 m 	89728

11.2 Spare parts

11.2.1 LA balances, readability 0.1 mg

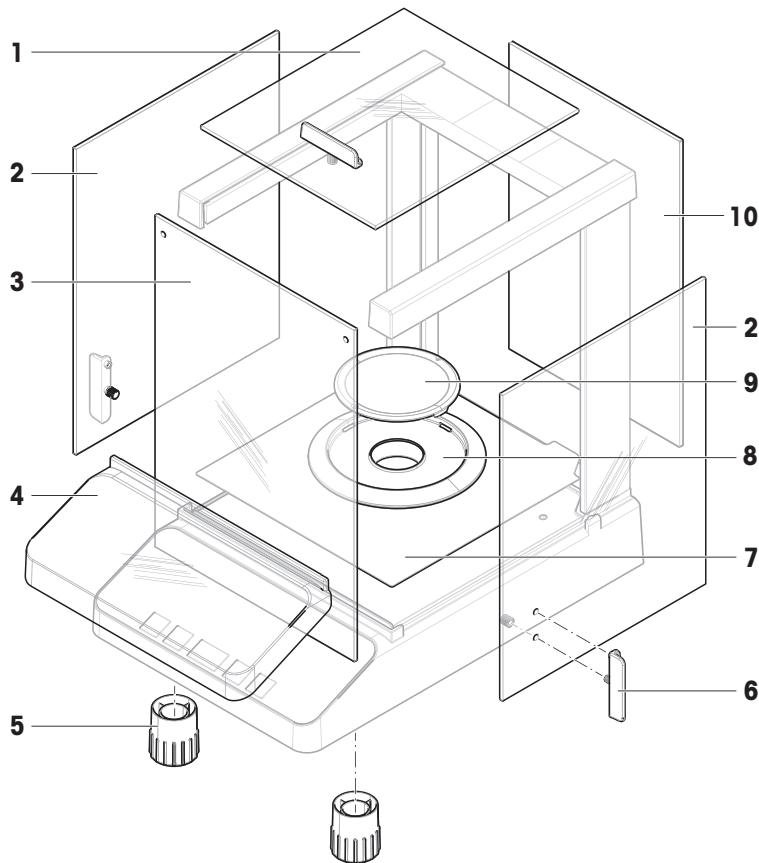

	Order no.	Designation	Remarks
1	30037733	Door top draft shield	Material: Glass; Including: Door handle
2	30037732	Door left and right draft shield, set	Material: Glass; Including: 2 Door handles
3	30037735	Panel front draft shield	Material: Glass; Including: 2 retainer
4	30834134	Protective cover	—
5	30037744	Leveling foot	Including: 2 leveling feet
6	30037736	Door handle draft shield	Including: 2 door handles
7	30098666	Bottom plate	—
8	30216708	Draft protection element	For weighing pan \varnothing 80 mm
9	30098665	Weighing pan \varnothing 80 mm	Including: Pan support
10	30037734	Panel back draft shield	Material: Glass

11.2.2 LA balances, readability 1 mg

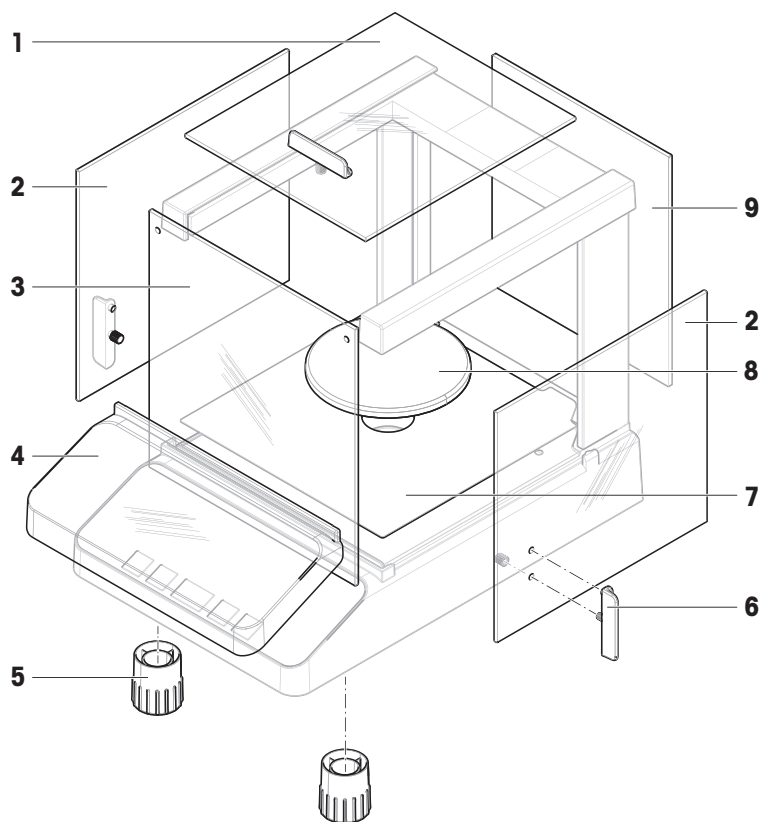

	Order no.	Designation	Remarks
1	30037733	Door top draft shield	Material: Glass; Including: Door handle
2	30042885	Door left and right draft shield, set	Material: Glass; Including: 2 door handles
3	30042888	Panel front draft shield	Material: Glass; Including: 2 retainer
4	30834134	Protective cover	–
5	30037744	Leveling foot	Including: 2 leveling feet
6	30037736	Door handle draft shield	Including: 2 door handles
7	30098666	Bottom plate	–
8	30098685	Weighing pan \varnothing 100 mm	Including: Pan support
9	30042887	Panel back draft shield	Material: Glass

11.2.3 LA balances, readability 10 mg

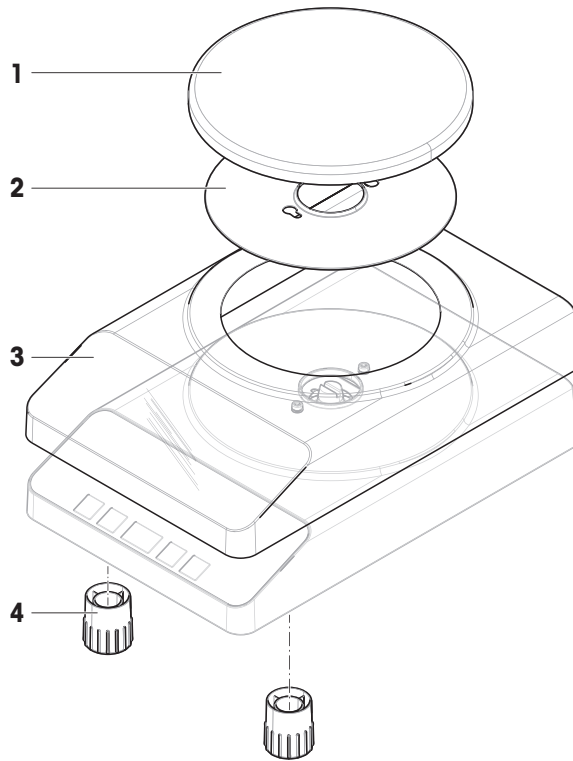

	Order no.	Designation	Remarks
1	30098690	Weighing pan \varnothing 180 mm	Excluding: Pan support
2	30098691	Bottom plate	–
3	30834135	Protective cover	–
4	30037744	Leveling foot	Including: 2 leveling feet

11.2.4 AC/DC adapter, universal

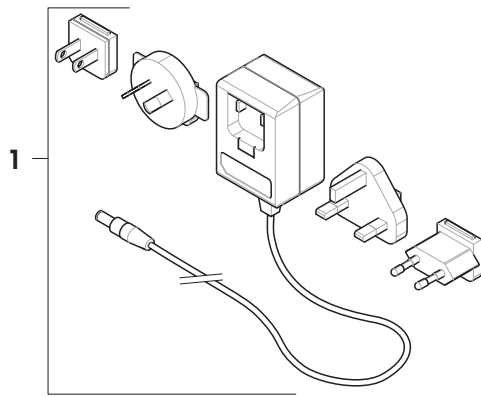

	Order no.	Designation	Remarks
1	11120270	AC/DC adapter universal	Including: plug for EU, USA, AU, UK

11.2.5 Packaging

11.2.5.1 Packaging for balances with readability of 0.1 mg

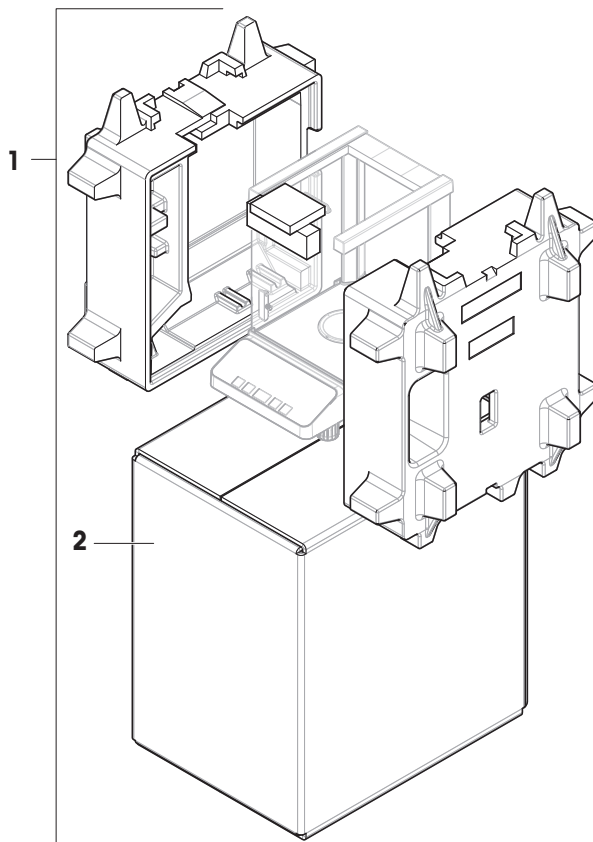

	Order no.	Designation	Remarks
1	30098674	Packaging	Including: export box, inner protection material
2	30098675	Export box	Excluding: inner protection material

11.2.5.2 Packaging for balances with readability of 1 mg

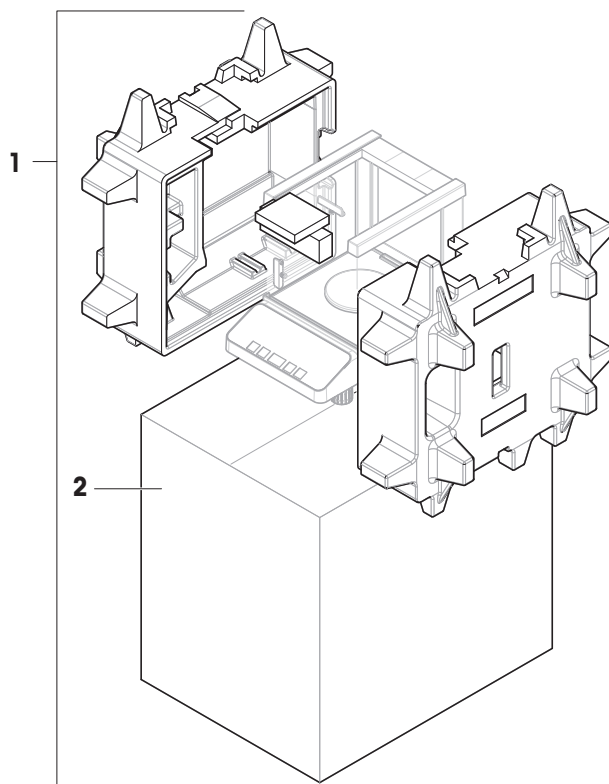

	Order no.	Designation	Remarks
1	30098687	Packaging	Including: export box, inner protection material
2	30098688	Export box	Excluding: inner protection material

11.2.5.3 Packaging for balances with readability of 10 mg

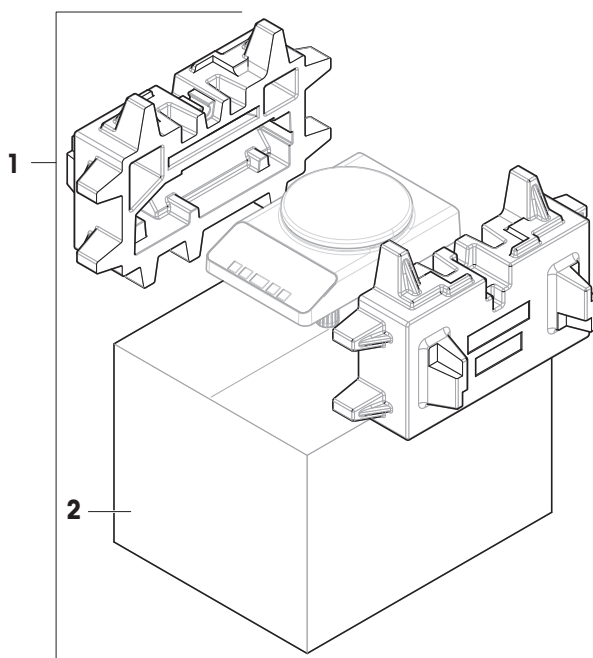

	Order no.	Designation	Remarks
1	30098692	Packaging	Including: export box, inner protection material
2	30098693	Export box	Excluding: inner protection material

12 Disposal

In conformance with the European Directive 2012/19/EU on Waste Electrical and Electronic Equipment (WEEE), this equipment may not be disposed of in domestic waste. This also applies to countries outside the EU, per their specific requirements.

Please dispose of this equipment in accordance with local regulations at the collecting point specified for electrical and electronic equipment. If you have any questions, please contact the responsible authority or the distributor from which you purchased this equipment. Should this equipment be passed on to other parties, the content of this directive must also be passed on to the other party.



13 Compliance Information

National approval documents, e.g., the FCC Supplier Declaration of Conformity, are available online and/or included in the packaging.

▶ www.mt.com/ComplianceSearch

Contact METTLER TOLEDO for questions about the country-specific compliance of your instrument.

▶ www.mt.com/contact

United States of America

This equipment has been tested and found to comply with the limits for a **Class A** digital device, pursuant to part 15 of the FCC Rules. These limits are designed to provide reasonable protection against harmful interference when the equipment is operated in a commercial environment. This equipment generates, uses, and can radiate radio frequency energy and, if not installed and used in accordance with the instruction manual, may cause harmful interference to radio communications. Operation of this equipment in a residential area is likely to cause harmful interference in which case the user will be required to correct the interference at his own expense.

This device complies with Part 15 of the FCC Rules. Operation is subject to the following two conditions:

1. This device may not cause harmful interference.
2. This device must accept any interference received, including interference that may cause undesired operation.

Changes or modifications not expressly approved by the party responsible for compliance could void the user's authority to operate the equipment.

Index

A

Adjusting	17
adjustment	25
external	17
internal	17
Advanced menu	23
altitude	46
Application dynamic weighing	34
application icon	9
Application piece counting	32
Applications	9, 10
Auto print	29
Automatic standby	26
Automatic zero setting	27
Autozero	27

B

Backlight	27
Basic menu	23, 24
Basic principles for operation	9
Baudrate	30
below-the-balance weighing	22
Bit/Parity	30

C

Cancel	11
Change settings	10, 11
Char set	31
Cleaning	38
Closing the menu	11
compliance information	68
convention	3

D

Data communication format	29
Date	16, 24
Date format	26
dimension	53, 54, 55
display	9, 28
disposal	67
Draft shield	38, 39
Dynamic weighing	34

E

End of line	31
Environment	25

environmental condition	12, 46
external adjustment	17
external weight	17

F

Function PC-Direct	36
--------------------	----

H

Handles	39
Handshake	30
Header	28
Host	28
humidity	46

I

icon	9
Identification	25
Input principle	11
install	
site	12
Installing	
Handles	39
Interface	
MT-SICS	56
Interface menu	23, 27
Interface RS232C	27, 56
internal adjustment	17
internal weight	17
Interval	31

L

level	
balance	14
Level indicator	14
Leveling	14
Line feed	29
location	12

M

Main menu	24
materials	46
Menu	24
Menu advanced	23
Menu basic	23, 24
Menu interface	23, 27
Menu operation	9
Menu topic	10, 24

MT-SICS	56
N	
Numerical values	11
O	
ON / OFF	20
Operating temperature	14
P	
PC-DIR	28
PC-Direct	36
Performing a simple weighing	19
Piece counting	32
Power supply	46
Print	20
Print menu	25
Printer	27
R	
Recall	20, 26
Reset	25
RS232C interface	27, 56
S	
safety information	5
Saving settings	11
Select menu	10
Select menu topic	10
Selecting weighing application	9, 10
Service	27, 38
Service date reset	27
Service icon	27
Service reminder	27
Set identification	25
Setting date and time	16
Setting up the balance	12
Signature line	29
Single	28
software	
version	3
Standby	26
status icon	9
Stop bit	30
Submenu	11
Switching off	20
Switching weight units	19

symbol	3
warning	5
T	
Taring	19
Technical data	46
temperature	46
Time	16, 24
warm up	46
Time format	26
Topic	10, 24
Transmit data	20
Transport over short distances	21
Transporting the balance	21
U	
Unit	24, 25
W	
warm up	
time	46
Warm-up time	14
warning symbol	5
Weighing application	9, 10
Weighing-in aid	20
Weight unit	19, 24, 25
Z	
Zero print	29
Zero range	27
Zero setting	19
Zeroing	27

To protect your product's future:

METTLER TOLEDO Service assures the quality, measuring accuracy and preservation of value of this product for years to come.

Please request full details about our attractive terms of service.

► www.mt.com/service

www.mt.com/LA-balances

For more information

Mettler-Toledo GmbH

Im Langacher 44
8606 Greifensee, Switzerland
www.mt.com/contact

Subject to technical changes.
© 07/2024 METTLER TOLEDO. All rights reserved.
30572164B en



30572164