

# Jewelry Balances

JL-GE

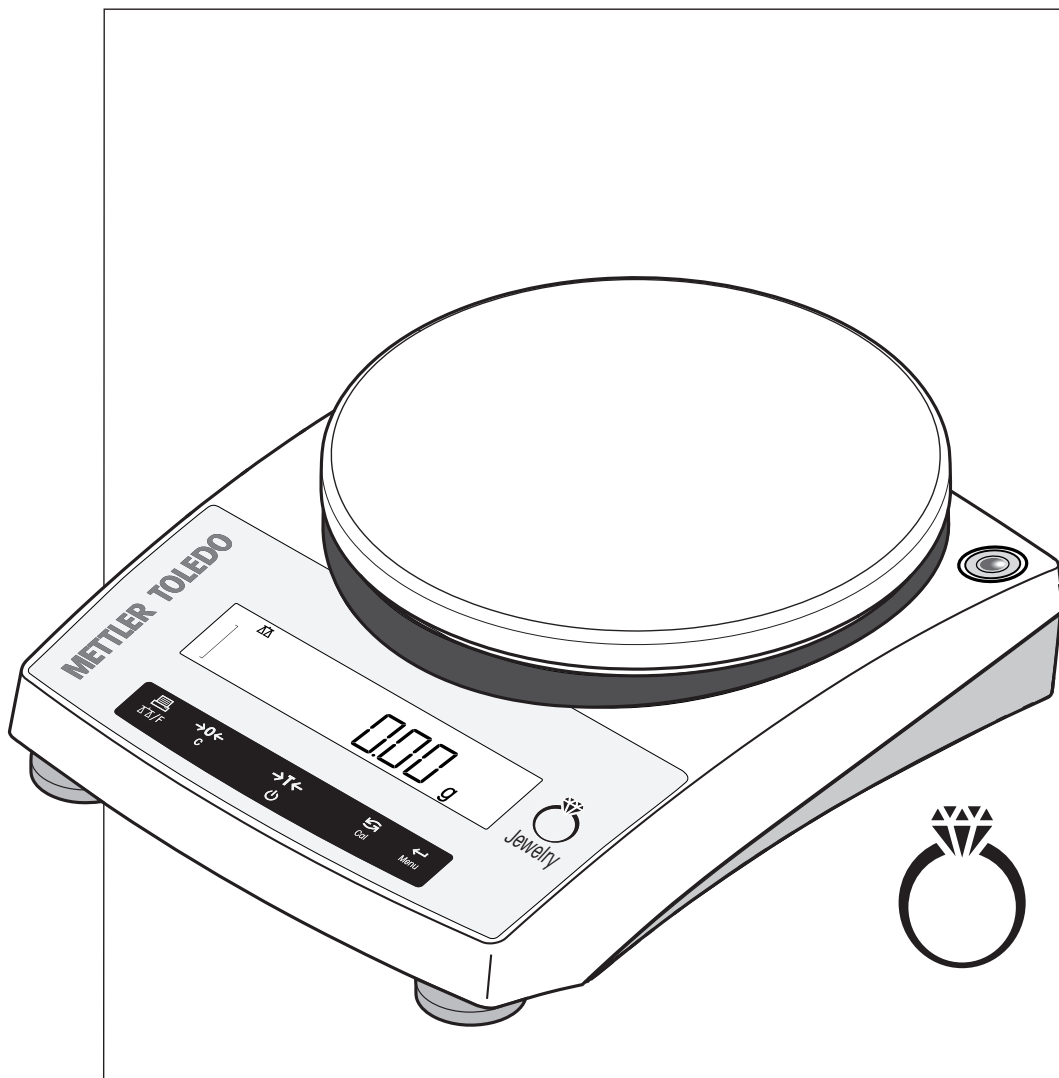

METTLER TOLEDO



# Table of Contents

<b>1</b>	<b>Introduction</b>	<b>3</b>
1.1	Further documents and information .....	3
1.2	Explanation of conventions and symbols used .....	3
1.3	Acronyms and abbreviations .....	4
1.4	Compliance information .....	4
<b>2</b>	<b>Safety Information</b>	<b>5</b>
2.1	Definitions of signal words and warning symbols .....	5
2.2	Product-specific safety notes .....	5
<b>3</b>	<b>Design and Function</b>	<b>7</b>
3.1	Overview .....	7
3.1.1	Overview balance .....	7
3.1.2	Overview type plate .....	7
3.1.3	Overview operation keys .....	8
3.1.4	Display .....	8
3.2	Basic principles for operation .....	9
<b>4</b>	<b>Installation and Putting into Operation</b>	<b>12</b>
4.1	Selecting the location .....	12
4.2	Scope of delivery .....	12
4.3	Unpacking the balance .....	12
4.4	Installation .....	13
4.4.1	Assembling the balance .....	13
4.4.2	Installing the protective cover .....	13
4.4.3	Using batteries .....	13
4.4.3.1	Inserting or replacing batteries .....	14
4.5	Putting into operation .....	15
4.5.1	Connecting the balance .....	15
4.5.2	Switching on the balance .....	15
4.5.3	Leveling the balance .....	16
4.5.4	Adjusting the balance .....	17
4.5.4.1	Adjustment with external weight .....	17
4.6	Performing a simple weighing .....	17
4.7	Weighing below the balance .....	19
4.8	Transporting, packing, and storing .....	20
4.8.1	Transporting over short distances .....	20
4.8.2	Transporting over long distances .....	20
4.8.3	Packing and storing .....	20
<b>5</b>	<b>The Menu</b>	<b>22</b>
5.1	Overview .....	22
5.2	Main menu .....	23
5.3	Basic menu .....	23
5.4	Advanced menu .....	25
5.5	Interface menu .....	27
<b>6</b>	<b>Applications</b>	<b>31</b>
6.1	Piece counting .....	31
6.2	Percent weighing .....	34
6.3	Check weighing .....	36
6.4	Statistics .....	38
6.5	Totaling .....	40
6.6	Multiplication factor weighing .....	42
6.7	Division factor weighing .....	44

<b>7</b>	<b>Communication with Peripheral Devices</b>	<b>46</b>
7.1	Send weight value via RS232 to a computer using PC-Direct .....	46
7.1.1	Installing SerialPortToKeyboard software .....	46
7.1.2	Software settings .....	47
7.1.3	Balance settings .....	47
7.2	Collecting measurement results and balance details with EasyDirect Balance .....	47
<b>8</b>	<b>Maintenance</b>	<b>49</b>
8.1	Maintenance tasks .....	49
8.2	Cleaning .....	49
8.2.1	Cleaning the balance .....	49
8.2.2	Putting into operation after cleaning .....	50
<b>9</b>	<b>Troubleshooting</b>	<b>51</b>
9.1	Error messages .....	51
9.2	Error symptoms .....	52
9.3	Status icons .....	55
9.4	Putting into operation after fixing an error .....	55
<b>10</b>	<b>Technical Data</b>	<b>56</b>
10.1	General data .....	56
10.2	Dimensions .....	59
10.3	Interface specifications .....	60
10.3.1	RS232C interface .....	60
10.3.2	MT-SICS interface commands and functions .....	60
<b>11</b>	<b>Accessories and Spare Parts</b>	<b>61</b>
11.1	Accessories .....	61
11.2	Spare parts .....	62
<b>12</b>	<b>Disposal</b>	<b>64</b>
	<b>Index</b>	<b>65</b>

# 1 Introduction

Thank you for choosing a METTLER TOLEDO balance. The balance combines high performance with ease of use.

This document is based on the software version V 2.02.

## EULA

The software in this product is licensed under the METTLER TOLEDO End User License Agreement (EULA) for Software.

▶ [www.mt.com/EULA](http://www.mt.com/EULA)

When using this product you agree to the terms of the EULA.

## 1.1 Further documents and information

▶ [www.mt.com/jewelry](http://www.mt.com/jewelry)

This document is available in other languages online.

▶ [www.mt.com/JL-GE-RM](http://www.mt.com/JL-GE-RM)

Instructions for cleaning a balance: "8 Steps to a Clean Balance"

▶ [www.mt.com/lab-cleaning-guide](http://www.mt.com/lab-cleaning-guide)

Search for software downloads

▶ [www.mt.com/labweighing-software-download](http://www.mt.com/labweighing-software-download)

Search for documents

▶ [www.mt.com/library](http://www.mt.com/library)

For further questions, please contact your authorized METTLER TOLEDO dealer or service representative.

▶ [www.mt.com/contact](http://www.mt.com/contact)

## 1.2 Explanation of conventions and symbols used

### Conventions and symbols

Key and/or button designations and display texts are shown in graphic or bold text, e.g.,  **DATE**.

 **Note** For useful information about the product.



Refers to an external document.



This symbol indicates press key briefly (less than 1.5 s).



This symbol indicates press and hold key down (longer than 1.5 s).



This symbol indicates a flashing display.

## Elements of instructions

In this manual, step-by-step instructions are presented as follows. The action steps are numbered and can contain prerequisites, intermediate results and results, as shown in the example. Sequences with less than two steps are not numbered.

- Prerequisites that must be fulfilled before the individual steps can be executed.
- 1 Step 1
  - ➔ Intermediate result
- 2 Step 2
  - ➔ Result

## 1.3 Acronyms and abbreviations

Original term	Explanation
ASTM	American Society for Testing and Materials
EMC	Electromagnetic Compatibility
FCC	Federal Communications Commission
GWP	Good Weighing Practice
ID	Identification
MT-SICS	METTLER TOLEDO Standard Interface Command Set
OIML	Organisation Internationale de Métrologie Légale (International Organization of Legal Metrology)
RM	Reference Manual
SNR	Serial Number
UM	User Manual
USB	Universal Serial Bus

## 1.4 Compliance information

National approval documents, e.g., the FCC Supplier Declaration of Conformity, are available online and/or included in the packaging.

► <http://www.mt.com/ComplianceSearch>

Contact METTLER TOLEDO for questions about the country-specific compliance of your instrument.

► [www.mt.com/contact](http://www.mt.com/contact)

### United States of America

This equipment has been tested and found to comply with the limits for a **Class A** digital device, pursuant to part 15 of the FCC Rules. These limits are designed to provide reasonable protection against harmful interference when the equipment is operated in a commercial environment. This equipment generates, uses, and can radiate radio frequency energy and, if not installed and used in accordance with the instruction manual, may cause harmful interference to radio communications. Operation of this equipment in a residential area is likely to cause harmful interference in which case the user will be required to correct the interference at his own expense.

Changes or modifications not expressly approved by the party responsible for compliance could void the user's authority to operate the equipment.

## 2 Safety Information

Two documents named "User Manual" and "Reference Manual" are available for this instrument.

- The User Manual is printed and delivered with the instrument.
- The electronic Reference Manual contains a full description of the instrument and its use.
- Keep both documents for future reference.
- Include both documents if you transfer the instrument to other parties.

Only use the instrument according to the User Manual and the Reference Manual. If you do not use the instrument according to these documents or if the instrument is modified, the safety of the instrument may be impaired and Mettler-Toledo GmbH assumes no liability.

### 2.1 Definitions of signal words and warning symbols

Safety notes contain important information on safety issues. Ignoring the safety notes may lead to personal injury, damage to the instrument, malfunctions and false results. Safety notes are marked with the following signal words and warning symbols:

#### Signal words

<b>DANGER</b>	A hazardous situation with high risk, resulting in death or severe injury if not avoided.
<b>WARNING</b>	A hazardous situation with medium risk, possibly resulting in death or severe injury if not avoided.
<b>CAUTION</b>	A hazardous situation with low risk, resulting in minor or moderate injury if not avoided.
<b>NOTICE</b>	A hazardous situation with low risk, resulting in damage to the instrument, other material damage, malfunctions and erroneous results, or loss of data.

#### Warning symbols



General hazard



Notice

### 2.2 Product-specific safety notes

#### Intended use

This instrument is designed to be used by trained staff. The instrument is intended for weighing purposes.

Any other type of use and operation beyond the limits of use stated by Mettler-Toledo GmbH without consent from Mettler-Toledo GmbH is considered as not intended.

#### Responsibilities of the instrument owner

The instrument owner is the person holding the legal title to the instrument and who uses the instrument or authorizes any person to use it, or the person who is deemed by law to be the operator of the instrument. The instrument owner is responsible for the safety of all users of the instrument and third parties.

Mettler-Toledo GmbH assumes that the instrument owner trains users to safely use the instrument in their workplace and deal with potential hazards. Mettler-Toledo GmbH assumes that the instrument owner provides the necessary protective gear.

## Safety notes



### **WARNING**

#### **Death or serious injury due to electric shock**

Contact with parts that carry a live current can lead to death or injury.

- 1 Only use the METTLER TOLEDO power cable and AC/DC adapter designed for your instrument.
- 2 Connect the power cable to a grounded power outlet.
- 3 Keep all electrical cables and connections away from liquids and moisture.
- 4 Check the cables and the power plug for damage and replace them if damaged.



### **NOTICE**

#### **Damage to the instrument or malfunction due to the use of unsuitable parts**

- Only use parts from METTLER TOLEDO that are intended to be used with your instrument.



### **NOTICE**

#### **Damage to the instrument or software**

In some countries, excessive mains voltage fluctuations and strong glitches may occur. This may affect the instrument functions or damage the software.

- Use a voltage regulator for stabilizing.



### 3 Design and Function

#### 3.1 Overview

##### 3.1.1 Overview balance

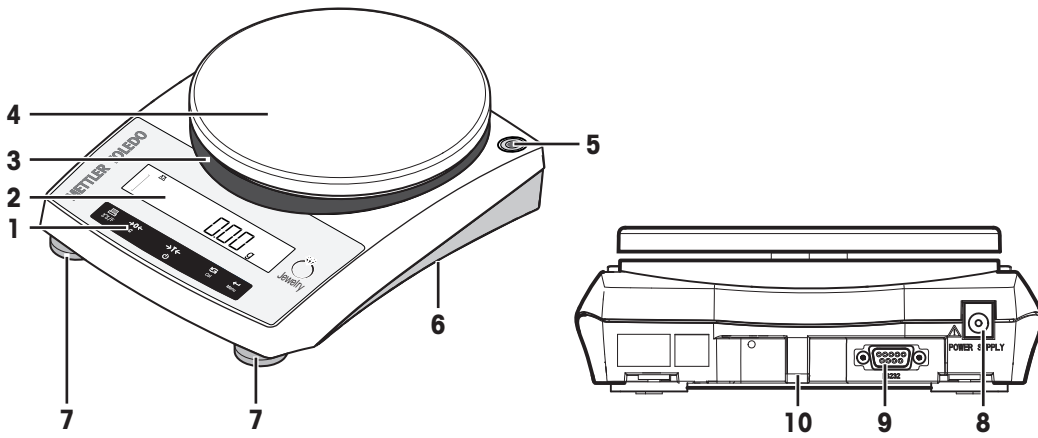

<b>1</b>	Operation keys	<b>6</b>	Bottom of balance: <ul style="list-style-type: none"> <li>• Battery compartment</li> <li>• Weighing hook opening for weighing below the balance</li> </ul>
<b>2</b>	Display	<b>7</b>	Leveling feet
<b>3</b>	Adapter ring	<b>8</b>	Socket for AC/DC adapter
<b>4</b>	Weighing pan	<b>9</b>	RS232C serial interface
<b>5</b>	Level indicator	<b>10</b>	Lug for anti-theft purposes

##### 3.1.2 Overview type plate

The balance type plate is located at the side of the balance and contains the following information (example illustration):

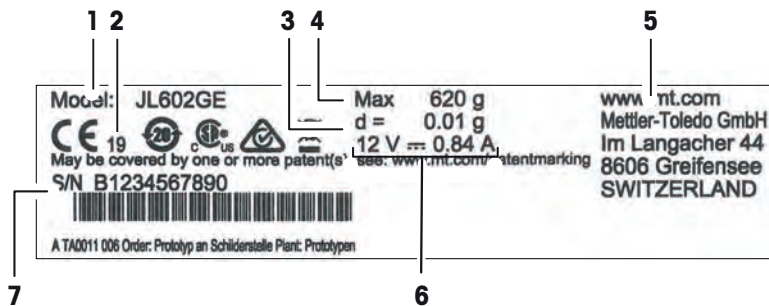

<b>1</b>	Model designation	<b>5</b>	Manufacturer
<b>2</b>	Year of manufacture	<b>6</b>	Power supply
<b>3</b>	Readability	<b>7</b>	Serial number (SNR)
<b>4</b>	Maximum capacity		

### 3.1.3 Overview operation keys

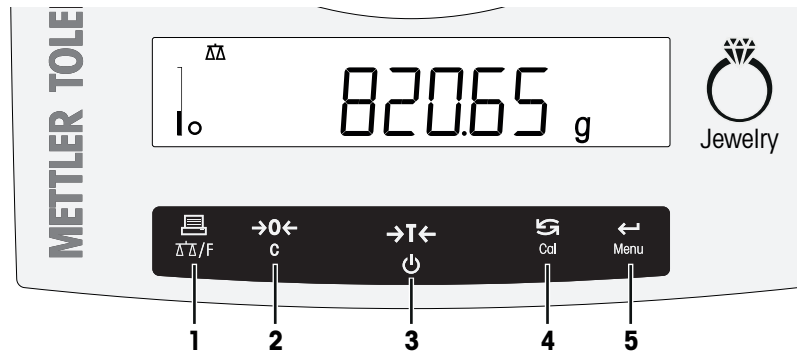

	Key	Press briefly (less than 1.5 s)	Press and hold (longer than 1.5 s)
1		<ul style="list-style-type: none"> <li>Printout display value</li> <li>Transmit data</li> <li>To navigate backward in the menu or menu selection</li> <li>Decrease parameters in menu or applications</li> </ul>	<ul style="list-style-type: none"> <li>Open the application list and scroll among the weighing applications in certain sequence for selecting an application</li> <li>Exits an active application and returns to the selection for weighing mode</li> </ul>
2		<ul style="list-style-type: none"> <li>Zero setting</li> </ul>	<ul style="list-style-type: none"> <li>Cancel and leave menu without saving</li> <li>One step back in the menu</li> <li>Cancel or leave application setting</li> </ul>
3		<ul style="list-style-type: none"> <li>Tare</li> <li>Switch on</li> </ul>	<ul style="list-style-type: none"> <li>Switch off</li> </ul>
4		<ul style="list-style-type: none"> <li>With entries, scroll down</li> <li>To navigate forward menu topics or menu selections</li> <li>To toggle between unit 1, recall value (if selected), unit 2 (if different from unit 1) and the application unit (if any)</li> <li>Increase parameters in menu or applications</li> </ul>	<ul style="list-style-type: none"> <li>Execute predefined adjustment (calibration) procedure</li> </ul>
5		<ul style="list-style-type: none"> <li>Enter or leave menu selection</li> <li>To enter application parameter and switch to next parameter</li> <li>To store parameter</li> </ul>	<ul style="list-style-type: none"> <li>Enter or leave menu (parameter settings)</li> </ul>

### 3.1.4 Display

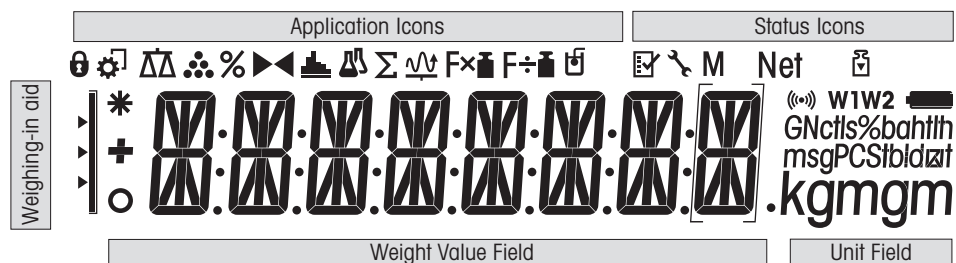

Application icons			
	Application weighing		Application totaling
	Application piece counting		Application multiplication factor
	Application percent weighing		Application division factor
	Application check weighing		Menu locked
	Application statistics		

While an application is running, the corresponding application icon appears at the top of the display.

Status icons			
<b>M</b>	Indicates stored value (Memory)		Feedback for pressed keys
<b>Net</b>	Indicates net weight values		Service reminder
	Adjustments (calibration) started		

Weight value field and weighing-in aid			
	Brackets to indicate uncertified digits (approved models only)		SmartTrac (weighing-in aid) shows how much of the entire weighing range has been used.
	Indicates negative values		Marking of nominal or target weight
	Indicates unstable values		Marking of tolerance limit T+
	Indicates calculated values		Marking of tolerance limit T-

Unit field						
<b>GNctls%bahtlh msgPCStlbdzft kgmgm</b>	<b>g</b>	gram	<b>ozt</b>	troy ounce	<b>tls</b>	Singapore taels
	<b>kg</b>	kilogram	<b>GN</b>	grain	<b>tlt</b>	Taiwan taels
	<b>mg</b>	milligram	<b>dwt</b>	pennyweight	<b>tola</b>	tola
	<b>ct</b>	carat	<b>mom</b>	momme	<b>baht</b>	baht
	<b>lb</b>	pound	<b>msg</b>	mesghal		
	<b>oz</b>	ounce	<b>tlh</b>	Hong Kong taels		

## 3.2 Basic principles for operation

### Selection of simple weighing or applications

- Press and hold  $\Delta\Delta/F$  until **APP.LIST** (application list) appears on the display.
  - ➔ After releasing the key, weighing mode **WEIGH** appears on the display.
- Press  $\leftarrow$  to execute the simple weighing or press  $\rightarrow$  several times to select another application.
- Press  $\leftarrow$  to execute the selected application.

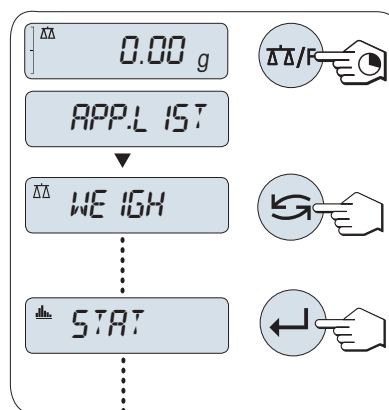



## Available applications

Display	Remark	Description
<b>WEIGH</b>	Weighing mode	See performing a simple weighing
<b>COUNT</b>	Piece counting	See application piece counting
<b>PERCENT</b>	Percent weighing	See application percent weighing
<b>CHECK</b>	Check weighing	See application check weighing
<b>STAT</b>	Statistics	See application statistics
<b>TOTAL</b>	Totaling	See application totaling
<b>FACTOR.M</b>	Multiplication factor	See application multiplication factor weighing
<b>FACTOR.D</b>	Division factor	See application division factor weighing

## Terminating a current application

- 1 Press and hold **C**, during the application setting.
  - ➔ The balance returns to the last active application.
- 2 Press and hold **ΔΔ/F**, during working with the application.
  - ➔ The balance returns to the selection for the weighing mode.



## Entering the menu

- 1 Press and hold **Menu** to enter main menu.
  - ➔ The first menu **BASIC** is displayed (except menu protection is active).
- 2 Press  repeatedly to change menu.
- 3 Press  to confirm the selection.

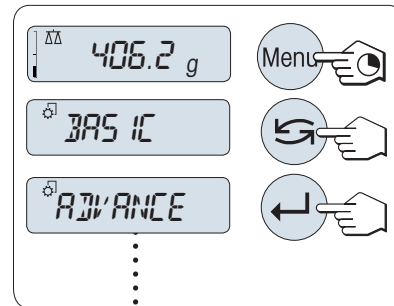
Detailed description of the menu **see** chapter The Menu.



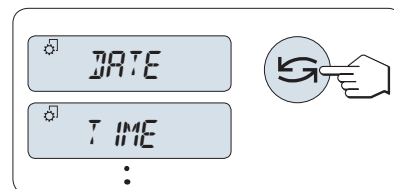

## Selecting menu topics

- 1 Press .
  - ➔ The next menu topic appears in the display.
- 2 Press  repeatedly, the balance switches to the next menu topic.



## Changing settings in selected menu topic

- 1 Press .
  - ➔ The display shows the current setting in the selected menu topic.
- 2 Press  repeatedly, the balance switches to the next selection.
  - ➔ After the last selection, the first is shown again.
- 3 Press  to confirm the setting.

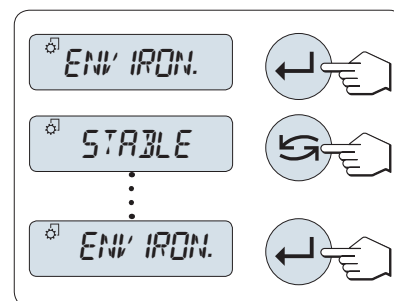

To save the settings, see "Saving settings and closing the menu".



## Changing settings in a submenu selection



The same procedure as for menu topics.

### Input principle of numerical values

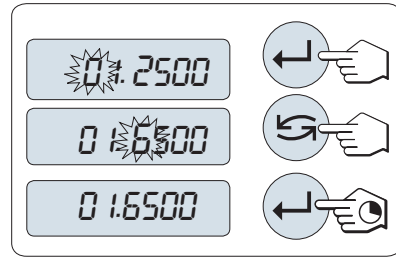
- 1 Press  to select a digit (cyclically from left to right) or a value (depending on the application).  
➔ The selected digit or the selected value is blinking.
- 2 Press  to increase or **F** to decrease for changing blinking digits or values.
- 3 Press and hold  to confirm the value.



### Saving settings and closing the menu

- 1 Press and hold **Menu** to leave menu topic.  
➔ **SAVE:YES** appears on the display.
- 2 Press  to toggle between **SAVE:YES** and **SAVE:NO**.
- 3 Press  to execute **SAVE:YES**.  
➔ Changes are saved.
- 4 Press  to execute **SAVE:NO**.  
➔ Changes are not saved.

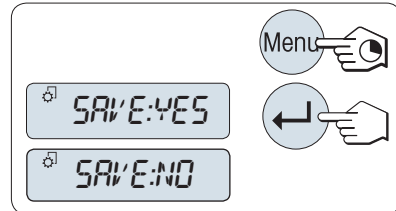

### Cancel

- During menu operation
- 1 Press **C** for leaving menu topic or menu selection without saving (one step back in the menu).
  - 2 To leave menu topic or menu selection without saving press **C** (one step back in the menu).
- During application operation
- Press **C** to cancel settings.  
➔ The balance returns to the previous active application.

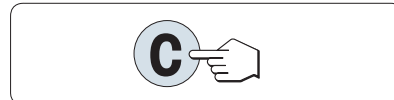

### Note

If no entry is made within 30 seconds, the balance reverts to last active application mode. Changes are not saved. If changes are made, the balance asks **SAVE:NO**.

## 4 Installation and Putting into Operation

### 4.1 Selecting the location

A balance is a sensitive precision instrument. The location where it is placed will have a profound effect on the accuracy of the weighing results.

#### Requirements of the location

Place indoors on stable table



Avoid direct sunlight



Ensure sufficient spacing

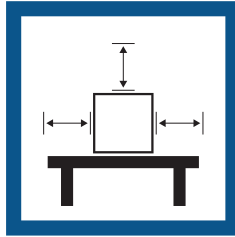

Avoid vibrations

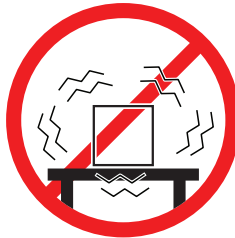

Level the instrument

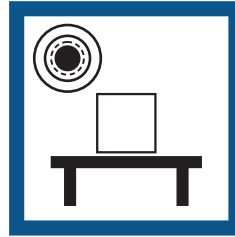

Avoid strong drafts



Provide adequate lighting

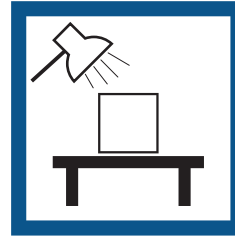

Avoid temperature fluctuations

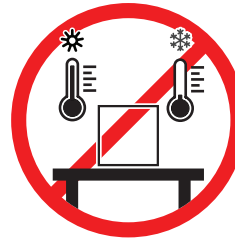

Sufficient distance: > 15 cm at the rear and side of the balance.

Take into account the environmental conditions. See "Technical Data".

### 4.2 Scope of delivery

- Balance
- Weighing pan and weighing pan support
- Protective cover for load cell cone (mounted)
- Protective cover (mounted)
- Stackable cover
- Universal AC/DC adapter (country specific)
- User Manual
- Declaration of Conformity

### 4.3 Unpacking the balance

Open the balance packaging. Check the balance for transport damage. Immediately inform a METTLER TOLEDO representative in the event of complaints or missing accessories.

Retain all parts of the packaging. This packaging offers the best possible protection for transporting the balance.

## 4.4 Installation

### 4.4.1 Assembling the balance

- 1 Remove the protective cover for the weighing cone (1).  
Keep it for later use.
- 2 Place the pan support (2) on the balance.
- 3 Place the weighing pan (3) on pan support (2).

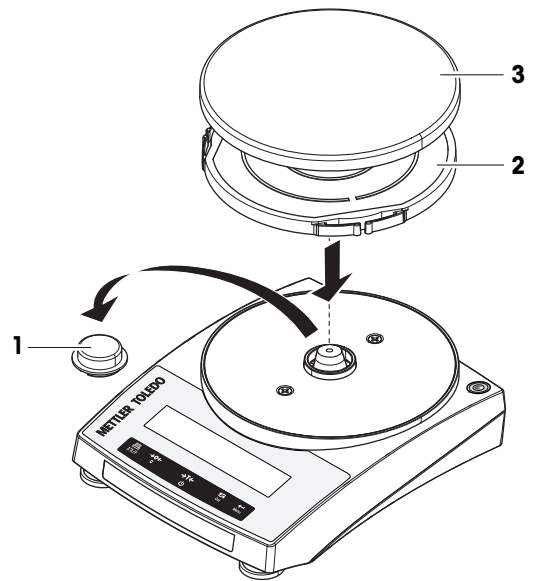

### 4.4.2 Installing the protective cover

- Install the protective cover according to the illustration, using a screwdriver.

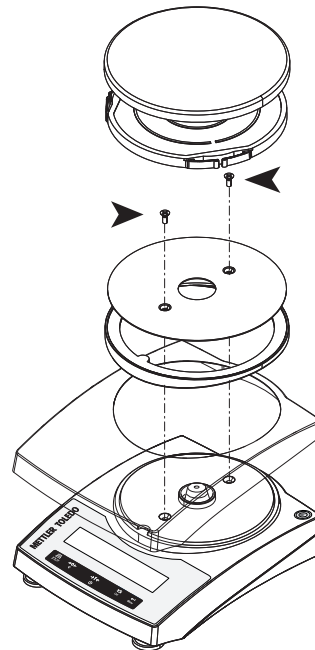

### 4.4.3 Using batteries

The balance can also operate with batteries. Under normal operation conditions, the balance works independently of the AC power line for about 8 to 15 hours (using alkaline batteries).

Immediately after the AC power supply is interrupted, e.g., by withdrawing the power plug or if there is a power failure, the balance switches automatically to battery operation. Once the AC power supply is restored, the balance reverts automatically to AC operation.

It is also possible to use rechargeable batteries. Charging batteries inside the balance is **not** possible.

Your balance uses 4 standard AA (LR6) batteries (alkaline batteries preferred).

When the balance is operating on its batteries, the battery symbol in the display lights up. The number of segments that are lit is an indicator of battery condition (3 = fully charged, 0 = discharged). When the batteries are almost completely discharged, the battery symbol flashes.

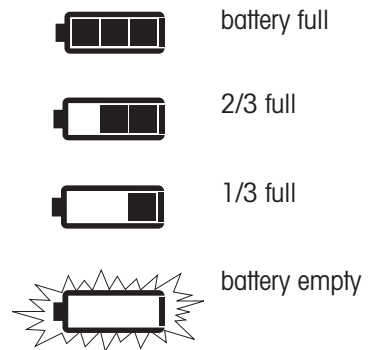

#### 4.4.3.1 Inserting or replacing batteries



#### **WARNING**

##### **Death or serious injury due to electric shock**

Contact with parts that contain a live current can lead to injury and death.

- Disconnect the instrument from the power supply when replacing the batteries.

- Read and follow all warnings and instructions supplied by the battery manufacturer.
- Do not mix different types or brands of batteries. Performance of batteries varies depending on the manufacturer.
- Remove the batteries from the balance if the balance is not used for a long period of time.
- Batteries must be disposed of properly, according to local regulations.

Proceed as follows:

- Make sure that the balance is switched off before removing or inserting batteries.
- 1 Remove weighing pan and pan support.
  - 2 Turn the balance carefully on its side.
  - 3 Open and remove the battery-chamber cover.
  - 4 Insert / replace the batteries with the correct polarity as shown in the battery holder.
  - 5 Insert and close the battery-chamber cover.
  - 6 Turn the balance carefully to its normal position.
  - 7 Reinstall all components in the reverse order.

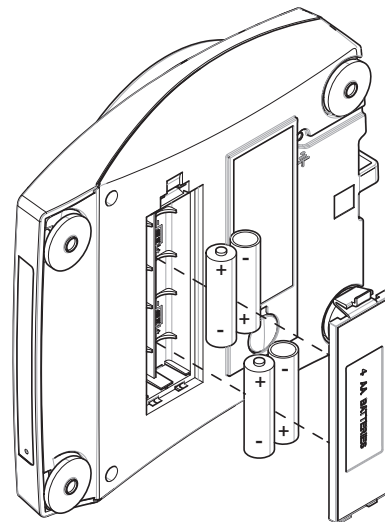



## 4.5 Putting into operation

### 4.5.1 Connecting the balance



#### **WARNING**

##### **Death or serious injury due to electric shock**

Contact with parts that carry a live current can lead to death or injury.

- 1 Only use the METTLER TOLEDO power cable and AC/DC adapter designed for your instrument.
- 2 Connect the power cable to a grounded power outlet.
- 3 Keep all electrical cables and connections away from liquids and moisture.
- 4 Check the cables and the power plug for damage and replace them if damaged.



#### **NOTICE**

##### **Damage to the AC/DC adapter due to overheating**

If the AC/DC adapter is covered or in a container, it is not sufficiently cooled and will overheat.

- 1 Do not cover the AC/DC adapter.
- 2 Do not put the AC/DC adapter in a container.

- Install the cables so that they cannot be damaged or interfere with operation.
  - Insert the power cable in a grounded power outlet that is easily accessible.
- 1 Connect the AC/DC adapter (1) to the connection socket on the back of your balance.
  - 2 Connect the power cable (2) to the power socket.
    - ➔ The balance performs a display test (all segments in the display light up briefly), **WELCOME**, **Software version**, **Maximum load** and **Readability** appears briefly.
    - ➔ The balance is ready to be used.

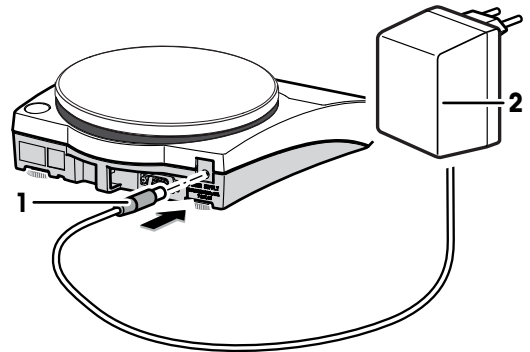

#### **Note**

Always connect the AC/DC adapter to the balance before connecting to the power.

Do not connect the instrument to a power outlet controlled by a switch. After switching on the instrument, it must warm up before giving accurate results.

### 4.5.2 Switching on the balance

Before using the balance, it must be warmed up in order to obtain accurate weighing results. To reach operating temperature, the balance must be acclimatized and connected to the power supply for at least 30 minutes.

### Operation using a power supply (standby mode)

- The balance is connected to the power supply.
- 1 Remove any load from the weighing pan.
- 2 Press .
  - ➔ The balance performs a display test. All segments in the display light up briefly, **WELCOME**, Software version, **Maximum load** and **Readability** appears briefly.
- ➔ The balance is ready for weighing or for operation with the last active application.

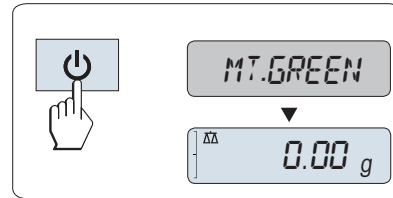

### Operation using batteries

- 1 Remove any load from the weighing pan.
- 2 Press .
  - ➔ The balance performs a display test (all segments in the display light up briefly), **WELCOME**, Software version, **Maximum load** and **Readability** appears briefly.
- ➔ After the warm-up time, the balance is ready for weighing or for operation with the last active application.

### Legal-for-trade

Approved balances will execute an initial zero.

## 4.5.3 Leveling the balance

Exact horizontal and stable positioning are essential for repeatable and accurate weighing results. There are four adjustable leveling feet to compensate for slight irregularities in the surface of the weighing bench.

The balance must be leveled and adjusted each time it is moved to a new location.

- 1 Position the balance at the selected location.
- 2 Align the balance horizontally.
- 3 Turning the leveling feet of the housing until the air bubble is in the middle of the glass.

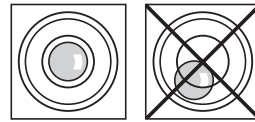

- 4 In this example, turn the left leveling feet counterclockwise.

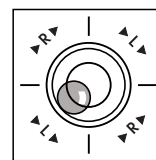

### Example

Air bubble at 12 o'clock:



turn both feet clockwise.



Air bubble at 3 o'clock:



turn left foot clockwise, right foot counterclockwise.



Air bubble at 6 o'clock:



turn both feet counterclockwise.



Air bubble at 9 o'clock:



turn left foot counterclockwise, right foot clockwise.



## 4.5.4 Adjusting the balance

To obtain accurate weighing results, the balance must be adjusted to match the gravitational acceleration at its location. This is also dependent on the ambient conditions. After reaching the operating temperature, it is important to adjust the balance in the following cases:

- Before the balance is used for the first time.
- If the balance has been disconnected from the power supply or in the event of power failure.
- After significant environmental changes, e.g., temperature, humidity, air draft or vibrations.
- At regular intervals during weighing service.

### 4.5.4.1 Adjustment with external weight

#### Legal-for-trade

Approved models must be adjusted at the place of operation. Before putting in operation, and depending on particular country certification legislation, the balance will then have to be checked and sealed by authorized personnel.

- In the menu topic **CAL** (Adjustment) of advanced menu **ADJ.EXT** must be selected.
- Required adjustment weight is ready.
- Weighing pan is unloaded.

- 1 Press and hold **CAL** to execute external adjustment.
    - ➔ The required (predefined) adjustment weight value flashes on the display.
  - 2 Place adjustment weight in center of pan.
    - ➔ The balance adjusts itself automatically.
  - 3 Remove adjustment weight, when **0.00 g** flashes.
- ➔ The adjusting is finished when the message **ADJ DONE** appears briefly on the display. The balance returns to the last active application and is ready for operation.

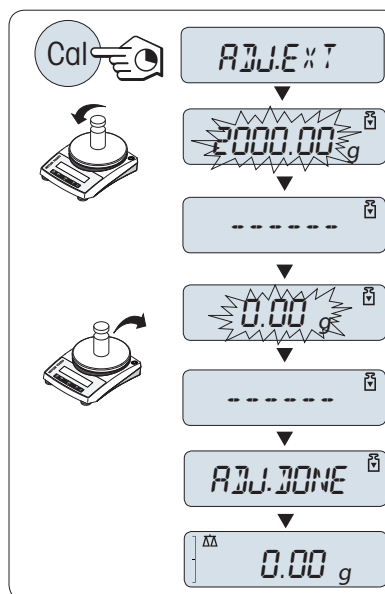

## 4.6 Performing a simple weighing



The weighing application allows you to perform simple weighings and how you can accelerate the weighing process.

If your balance is not in the weighing mode, press and hold the  $\Delta\Delta/F$  key down until **WEIGH** appears in the display. Press  $\leftarrow$ . Your balance is in the weighing mode.

- 1 Press  $\rightarrow 0 \leftarrow$  to zero the balance.
- 2 Place the sample on the weighing pan.
- 3 Wait until the instability detector  $\circ$  disappears.
- 4 Read the result.

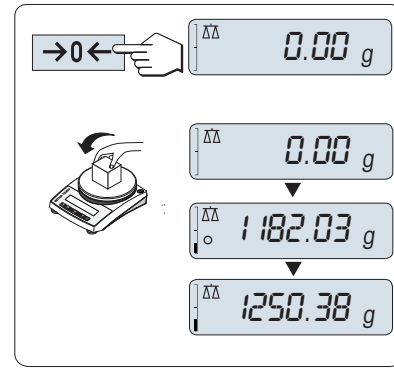

### Zeroing

Use the  $\rightarrow 0 \leftarrow$  zeroing key before you start with a weighing.

- 1 Unload the balance.
- 2 Press  $\rightarrow 0 \leftarrow$  to zero the balance.
  - ➔ All weight values are measured in relation to this zero point.

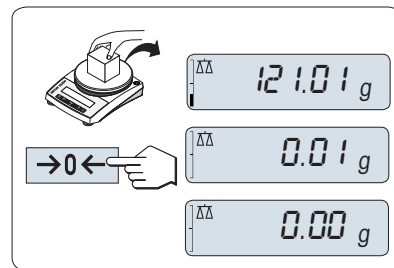

### Taring

If you are working with a weighing container, first set the balance to zero.

- 1 Place empty container on the weighing pan.
  - ➔ The weight is displayed.
- 2 Press  $\rightarrow T \leftarrow$  to tare the balance.
  - ➔ **0.00 g** and **Net** appears in the display. **Net** indicates that all weight values displayed are net values.
- 3 Place the sample in the container.
  - ➔ The result appears in the display.

If the container is removed from the balance, the tare weight will be shown as a negative value.

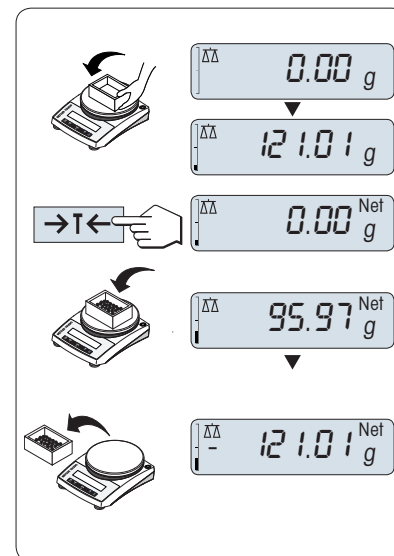

### Switching weight units

The  key can be used at any time to toggle between weight unit **UNIT 1**, **RECALL** value (if selected) and weight unit **UNIT 2** (if different from weight unit 1) and the application unit (if any).

- Press  to set weight unit or recall value.

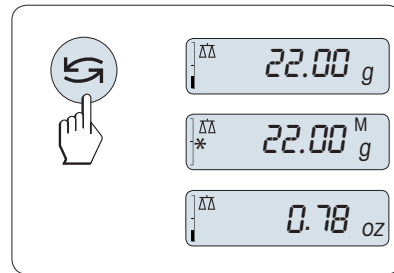

### Recall / recall weight value

Recall stores stable weights with an absolute display value bigger than 10d.

- Function **RECALL** is in the menu activated.
- 1 Load weighing sample.
    - ➔ The display shows weight value and stores stable value.
  - 2 Remove weighing sample.
    - ➔ The display shows zero.
  - 3 Press .
    - ➔ The display shows last stored stable weight value for 5 seconds together with asterisk (\*) and memory (M) symbols. After 5 seconds the display goes back to zero. This can be repeated unlimited times.

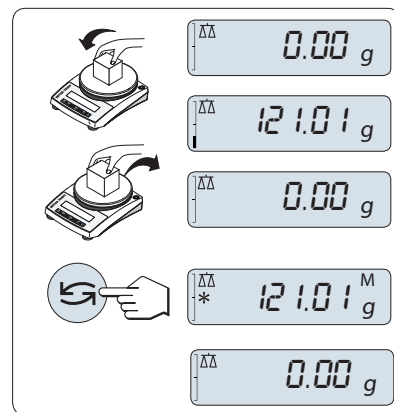

### Delete last weight value

As soon a new stable weight value is displayed, the old recall value becomes replaced by the new weight value.

- Press  **0/T** .
- ➔ The recall value is set to 0.

If the power is switched off, the recall value is lost. The recall value can not be printed.

### Weighing with the weighing-in aid

The weighing-in aid is a dynamic graphic indicator which shows the used amount of the total weighing range. You can thus recognize at a glance when the load on the balance approaches the maximum load.

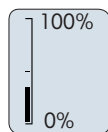

### Print / transmit data

Press the  key to transmit the weighing results over the interface, e.g., to a printer or a computer.

## 4.7 Weighing below the balance

Your balance is equipped with a weighing hook for performing weighing operations below the work surface (weighing below the balance).

- 1 Press and hold the  key.
- 2 Disconnect the balance from the power supply.

- 3 Disconnect all interface cables.
- 4 Remove weighing pan and pan support.
- 5 Turn the balance carefully on its side.
- 6 Remove the weighing-hook cover. Keep it for later use.
- 7 Turn the balance to its normal position and reinstall all components in the reverse order.

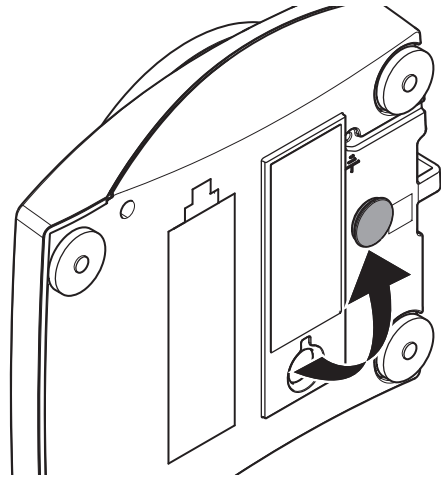

## 4.8 Transporting, packing, and storing

### 4.8.1 Transporting over short distances

To move the balance over a short distance to a new location, follow the instructions below.

- 1 Disconnect the balance from the AC/DC adapter.
- 2 Disconnect all interface cables.
- 3 Hold the balance with both hands.
- 4 Carefully lift the balance and carry it to its new location.

If you wish to put the balance into operation, proceed as follows:

- 1 Connect in reverse order.
- 2 Level the balance.
- 3 Perform an adjustment.

### 4.8.2 Transporting over long distances

To transport the balance over long distances, always use the original packaging.

### 4.8.3 Packing and storing

#### Packing

Store all parts of the packaging in a safe place. The elements of the original packaging are developed specifically for the balance and its components to ensure maximum protection during transportation or storing.

#### Storing

Store the balance under following conditions:

- Indoor and in the original packaging.
- According to the environmental condition, see "Technical data".
- When storing for longer than two days, the backup battery may be down (date and time get lost).

### Using the stackable cover

The stackable cover can be placed on the balance. It protects the balance from dust when it is not used and allows you to stack a maximal number of 5 balances.

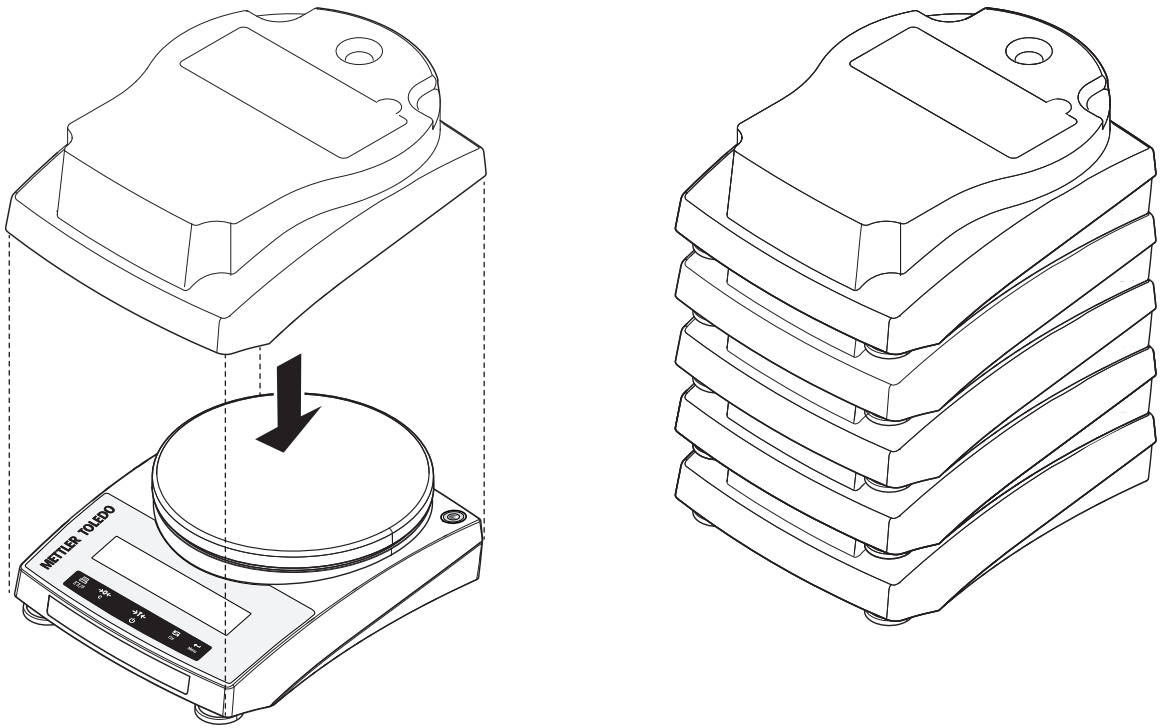

## 5 The Menu

### 5.1 Overview

In the menu you can change the settings of your balance and activate functions. The main menu has four different submenus containing different topics with various options.

For menu **PROTECT**, see [Main menu ▶ Page 23].

#### Menu BASIC

Topic	Description
<b>DATE</b>	Setting the current date.
<b>TIME</b>	Setting the current time.
<b>1/10 D</b>	Setting display increment (1/10d function)
<b>UNIT 1</b>	Specification of the 1 <sup>st</sup> weight unit in which the balance should show the result.
<b>UNIT 2</b>	Specification of the 2 <sup>nd</sup> weight unit in which the balance should show the result.
<b>SET ID</b>	Setting an identification.
<b>PRT.MENU</b>	Printing the settings.
<b>RESET</b>	Call up of the factory settings.

#### Menu ADVANCE.

Topic	Description
<b>ENVIRON.</b>	Matching the balance to the ambient conditions.
<b>CAL</b>	Settings for adjustment (calibration).
<b>DATE.FRM</b>	Setting the date format.
<b>TIME.FRM</b>	Preselection of the time format.
<b>RECALL</b>	Switching the application recall for storing stable weights on or off.
<b>STANDBY</b>	Setting the time after which the balance should be switched off automatically.
<b>B.LIGHT</b>	Switching on or off the display backlight.
<b>A.ZERO</b>	Switching the automatic zero correction (Autozero) on or off.
<b>SRV.ICON</b>	Switching the service reminder (service icon) on or off.
<b>SRV.D.RST</b>	Reset service date and hours (service reminder)

#### Menu INT.FACE

Topic	Description
<b>RS232</b>	Matching the serial interface RS232C to a peripheral unit.
<b>HEADER</b>	Setting the header for printout of individual values.
<b>SINGLE</b>	Setting the information for printout of individual values.
<b>SIGN.L</b>	Setting the footer for printout of individual values.
<b>LN.FEED</b>	Setting line feed for printout of individual values.
<b>ZERO.PRT</b>	Setting the auto print function for printing zero.
<b>COM.SET</b>	Setting the data communication format of the serial interface RS232C.
<b>BAUD</b>	Setting the transfer speed of the serial interface RS232C.
<b>BIT.PAR.</b>	Setting the character format (Bit/Parity) of the serial interface RS232C.
<b>STOPBIT</b>	Setting the character format (stop bit) of the serial interface RS232C.
<b>HD.SHK</b>	Setting the transfer protocol (Handshake) of the serial interface RS232C.
<b>RS.TX.E.O.L.</b>	Setting the end of line format of the serial interface RS232C.
<b>RS.CHAR</b>	Setting the char set of the serial interface RS232C.



Topic	Description
INTERVL.	Selection of the time interval for the simulated print key press.

## 5.2 Main menu

Selecting the submenu.

<b>BASIC</b>	The <b>BASIC</b> menu for simple weighing is displayed.
<b>ADVANCE.</b>	The <b>ADVANCE.</b> menu for further weighing settings is displayed.
<b>INT.FACE</b>	The menu <b>INT.FACE</b> for all interface parameter settings for peripheral devices e.g. printer is displayed.
<b>PROTECT</b>	Menu protection. Protection of balance configurations against unmeant manipulation.
<b>OFF</b>	Menu protection is off. ( <b>Factory setting</b> )
<b>ON</b>	Menu protection is on. The menu <b>BASIC</b> , <b>ADVANCE.</b> and <b>INT.FACE</b> are not displayed. This is indicated with <b>Ⓜ</b> in the display.

## 5.3 Basic menu

### DATE – Date

Setting the current date according to date format.



#### Note

A reset of the balance will not change this setting.

### TIME – Time

Setting the current time according to time format

<b>+1H</b>	Set the current time forwards by 1 hour (to adjust summer or winter time). ( <b>Factory setting</b> )
<b>-1H</b>	Set the current time backwards by 1 hour (to adjust summer or winter time).
<b>SET TIME</b>	Enter the current time.



#### Note

A reset of the balance will not change this setting.

### 1/10 D – Display increment 1/10 d

This menu topic allows you to reduce the readability of the display.

#### Legal-for-trade

This menu topic is not available with models which are approved and e=d.

<b>OFF</b>	<b>1/10 D</b> display increment is switched off (full resolution) ( <b>Factory setting</b> )
<b>ON</b>	<b>1/10 D</b> switched on (low resolution)

## UNIT 1 – Weight unit 1

The balance can operate with the following units (country and model specific).

### Legal-for-trade

- Only those weight units allowed by the appropriate national legislation are selectable.
- With approved balances, this menu topic has a fixed setting and cannot be changed.

#### Units:

<b>g</b>	Gram	<b>dwt</b>	Pennyweight
<b>kg</b>	Kilogram	<b>mom</b>	Momme
<b>mg</b>	Milligram	<b>msg</b>	Mesghal
<b>ct</b>	Carat	<b>tlh</b>	Tael Hong Kong
<b>lb</b>	Pound	<b>tls</b>	Tael Singapore
<b>oz</b>	Ounce (avdp)	<b>tit</b>	Tael Taiwan
<b>ozt</b>	Ounce (troy)	<b>tola</b>	Tola
<b>GN</b>	Grain	<b>baht</b>	Baht

## UNIT 2 – Weight unit 2

If it is required to show the weighing results in weighing mode in an additional unit, the desired second weight unit can be selected in this menu topic (country and model specific). Units see **UNIT 1**.

### Legal-for-trade

Only those weight units allowed by the appropriate national legislation are selectable.



### SET ID – Set identification

This menu topic allows you to set your own desired identification to the balance for the convenience of asset management or other purposes. The ID can be printed with other balance information. One ID can be set and max 7 alphanumeric characters are possible (blank, 0...9, A...Z).

#### SET ID

#### Set identification

The setting starts from left to right and the display prompts the configurable position by flashing corresponding place.

- **SET ID** is selected.
- 1 Search through (blank, 0...9, A...Z) by pressing .
  - 2 After selecting the character, press  to confirm and move to the next place. To store press and hold .

### PRT.MENU – Print menu

This menu topic allows you to execute a printout of the menu settings if a printer is connected. This topic is only visible if **PRINTER** mode is selected.

- **PRT.MENU** appears on the display and a printer is properly connected.
- To execute a printout press .

### RESET – Reset balance settings

This menu topic allows you to call-up the factory settings.

To toggle between **YES?** and **NO?** press .



#### Note

A reset of the balance will not change **DATE**, **TIME**, **1/10 D**, **SET ID** and **ZERO.RNG** settings.

## 5.4 Advanced menu

### ENVIRON. – Environment settings

This setting can be used to match your balance to the ambient conditions.

<b>STD.</b>	Setting for an average working environment subject to moderate variations in the ambient conditions. ( <b>Factory setting</b> )
<b>UNSTAB.</b>	Setting for a working environment where the conditions are continuously changing.
<b>STABLE</b>	Setting for a working environment which is practically free from drafts and vibrations.

### CAL – Adjustment (calibration)

In this menu topic you can preselect the function of the **Cal** key. Your balance can be adjusted with external weights by pressing the **Cal** key. If you have attached a printer to your balance, the data of the adjustment (calibration) are printed out.

<b>ADJ.OFF</b>	The adjustment is <b>switched off</b> . The <b>Cal</b> key has no function.
<b>ADJ.EXT</b>	<b>External</b> adjustment: adjustment is performed at a keystroke with a selectable external weight. <b>Legal-for-trade</b> This function is not available for approved balances * (depend on selected countries' certification legislation). * except OIML accuracy class I approved models. <b>200.00 g</b> <b>Defining the external adjustment weight:</b> define the weight of the external adjustment weight (in grams). <b>Factory setting:</b> depending on the model.

### DATE.FRM – Date format

This menu topic allows you to preselect the date format.

The following date formats are available:

	<b>Display examples</b>	<b>Printing examples</b>
<b>DD.MM.Y</b>	01.02.09	01.02.2009
<b>MM/DD/Y</b>	02/01/09	02/01/2009
<b>Y-MM-DD</b>	09-02-01	2009-02-01
<b>D.MMM Y</b>	1.FEB.09	1.FEB 2009
<b>MMM D Y</b>	FEB.1.09	FEB 1 2009

**Factory setting: DD.MM.Y**

### TIME.FRM – Time format

This menu topic allows you to preselect the time format.

The following date formats are available:

	<b>Display examples</b>
<b>24:MM</b>	15:04
<b>12:MM</b>	3:04 PM
<b>24.MM</b>	15.04
<b>12.MM</b>	3.04 PM

**Factory setting: 24:MM**

### **RECALL – Recall**

This menu topic allows you to switch the **RECALL** function on or off. When it is switched on recall stores the last stable weight if the absolute display value was bigger than 10d.

<b>OFF</b>	<b>RECALL switched off. (Factory setting)</b>
<b>ON</b>	<b>RECALL switched on.</b>

The recall value is displayed with an asterisk and cannot be printed.

### **STANDBY – Automatic standby**

If the automatic standby function is activated, the balance automatically switches itself after a pre selected time of inactivity into the energy saver mode **STANDBY** (e.g., with no key being pressed and no changes of weight occurring).

<b>A.OFF</b>	Automatic standby deactivated.
<b>A.ON</b>	Automatic standby activated. <b>(Factory setting)</b>
10	Time in minutes of inactivity for activating standby function.

### **B.LIGHT – Backlight**

Under this menu topic, the display backlight can be switched off or on.

<b>B.L. ON</b>	Backlight is always <b>on</b> . <b>(Factory setting)</b>
<b>B.L. OFF</b>	Backlight is always <b>off</b> .

### **A.ZERO – Automatic zero setting**

This menu topic allows you to switch the automatic zero setting on or off.



<b>ON</b>	<b>A.ZERO switched on (Factory setting)</b> . The automatic zero setting continuously corrects possible variations in the zero point that might be caused through small amounts of contamination on the weighing pan.
<b>OFF</b>	<b>A.ZERO switched off</b> . The zero point is not automatically corrected. This setting is advantageous for special applications, e.g., evaporation measurements.

### **Legal-for-trade**

With approved balances, this setting is not available in selected countries.

### **SRV.ICON – Service reminder**

This menu topic allows you to switch the service reminder  on or off.

<b>ON</b>	Service reminder  <b>switched on</b> . You will be informed to call service for recalibration. This will be indicated by the flashing service icon:  . <b>(Factory setting)</b>
<b>OFF</b>	Service reminder  <b>switched off</b> .

### **SRV.D.RST – Service date reset**

This menu topic allows you to reset service date.



#### **Note**











This menu topic is only available if **SRV.ICON** setting **ON** was selected.

To toggle between **YES?** and **NO?** press .

## 5.5 Interface menu

### RS232 – RS232C interface

This menu topic allows you to select the peripheral device connected to the RS232C interface and to specify how the data is transmitted.

<b>PRINTER</b>	Connection to a printer. <b>(Factory setting)</b> Only one printer possible.  Refer to your printer documentation for recommended printer settings.
<b>PRT.STAB</b>	If the  key is pressed, the next stable weight value will be printed. <b>(Factory setting)</b>
<b>PRT.AUTO</b>	Every stable weight value will be printed, without pressing the  key.
<b>PRT.ALL</b>	If the  key is pressed, the weight value will be printed regardless of stability.
<b>PC-DIR.</b>	Connection to a PC: the balance can send data (as a Keyboard) to the PC used for PC applications, e.g., Excel. <ul style="list-style-type: none"><li>• The balance sends the weight value without the unit to the PC.</li><li>• Not available on Win7.</li></ul>
<b>PRT.STAB</b>	If the  key is pressed, the next stable weight value will be sent followed by an enter. <b>(Factory setting)</b>
<b>PRT.AUTO</b>	Every stable weight value will be sent followed by an enter, without pressing the  key.
<b>PRT.ALL</b>	If the  key is pressed, the weight value will be sent followed by an enter regardless of stability.
<b>HOST</b>	Connection to a PC, barcode reader etc.: the balance can send data to the PC and receive commands or data from the PC. The balance sends the complete MT-SICS answer to the PC, <b>see</b> chapter "MT-SICS interface commands and functions".
<b>SND.OFF</b>	Send mode switched off. <b>(Factory setting)</b>
<b>SND.STB</b>	If the  key is pressed, the next stable weight value will be sent.
<b>SND.CONT</b>	All weight value updates will be sent regardless of stability, without pressing the  key.
<b>SND.AUTO</b>	Every stable weight value will be sent, without pressing the  key.
<b>SND.ALL</b>	If the  key is pressed, the weight value will be sent regardless of stability.
<b>2.DISP</b>	Connection of an optional auxiliary display unit. The transmission parameters cannot be selected. Settings are automatically set.

### HEADER – Options for the printout header of individual values

This menu topic allows you to specify the information that is to be printed at the top of the printout for every individual weighing results (after pressing .



#### Note

This menu topic is only available if **PRINTER** setting was selected.

<b>NO</b>	The header is not be printed. <b>(Factory setting)</b>
-----------	--

<b>DAT/TIM</b>	Date and time are printed.
<b>D/T/BAL</b>	Date, time and balance information (Balance type, SNR, Balance ID) are printed. Balance ID only if set.

### **SINGLE – Options for printing out the result of individual values**

This menu topic allows you to specify the information that is to be printed for every individual weighing result (after pressing .



#### **Note**

This menu topic is only available if **PRINTER** setting was selected.

<b>NET</b>	The value of the net weight from the current weighing is printed. <b>(Factory setting)</b>
<b>G/T/N</b>	The values of the gross weight, the tare weight and the net weight are printed.

### **SIGN.L – Options for the printout footer for signature line of individual values**

This menu topic allows you to set a footer for signature at the bottom of the printout for every individual weighing result (after pressing .



#### **Note**

This menu topic is only available if **PRINTER** setting was selected.

<b>OFF</b>	The signature footer is not be printed. <b>(Factory setting)</b>
<b>ON</b>	The signature footer is printed.

### **LN.FEED – Options for complete the printout of individual values**

This menu topic allows you to specify the number of blank lines to complete the printout for every individual weighing result (after pressing .



#### **Note**

This menu topic is only available if **PRINTER** setting was selected.

<b>0</b>	Possible numbers of blank lines: 0 to 99. <b>(Factory setting = 0)</b>
----------	--

### **ZERO.PRT – Options for PRT.AUTO <sup>1)</sup>**

This menu topic allows you to specify the auto print function **PRT.AUTO** for printing zero **YES** or **NO**.

<b>OFF</b>	Zero is not be printed (Zero +/- 3d). <b>(Factory setting)</b>
<b>ON</b>	Zero is always printed.



#### **Note**

This menu topic is only available if **PRT.AUTO** function of the **PRINTER** or **PC-DIR.** was selected.

### **COM.SET – Options for the data communication format (RS232C) (HOST)**

This menu topic allows you to set the data format depending on which peripheral device is connected.



#### **Note**

This menu topic is only available if **HOST** setting was selected.

<b>MT-SICS</b>	The MT-SICS data transfer formats is used. <b>(Factory setting)</b> For more information, see "MT-SICS interface commands and functions".
<b>SART</b>	The following Sartorius commands are supported: K Ambient conditions: very stable L Ambient conditions: stable

M	Ambient conditions: unstable
N	Ambient conditions: very unstable
O	Block keys
P	Print key (print, auto print; activate or block)
R	Unblock keys
S	Restart/self-test
T	Tare key
W	Calibration/adjustment <sup>*)</sup>
f1_	Function key (CAL)
s3_	C key
x1_	Print balance/scale model
x2_	Print weighing cell serial number
x3_	Print software version

<sup>\*)</sup> May be inaccessible on verified balances/scales

### Functionality mapping

<b>HOST settings:</b>	<b>Sartorius printer settings:</b>
<b>SND.OFF</b>	not applicable
<b>SND.STB</b>	manually print with stability
<b>SND.ALL</b>	manually print without stability
<b>SND.CONT</b>	automatically print without stability
<b>SND.AUTO</b>	similar applicable to automatically print when load is changed

### BAUD – Baud rate RS232C

This menu topic allows you to match the data transmission to different serial RS232C receivers. The baud rate (data transfer rate) determines the speed of transmission via the serial interface. For problem-free data transmission the sending and receiving devices must be set at the same value.

The following settings are available:

600 bd, 1200 bd, 2400 bd, 4800 bd, **9600 bd (Factory setting)**, 19200 and 38400 bd.



#### Note

- Not visible for 2nd display.
- Each device has separate settings.

### BIT.PAR. – Bit/Parity RS232C

This menu topic allows you to set the character format for the attached RS232C serial peripheral device.

<b>8/NO</b>	8 data bits/no parity ( <b>Factory setting</b> )
<b>7/NO</b>	7 data bits/no parity
<b>7/MARK</b>	7 data bits/mark parity
<b>7/SPACE</b>	7 data bits/space parity
<b>7/EVEN</b>	7 data bits/even parity
<b>7/ODD</b>	7 data bits/odd parity



#### Note

- Not visible for 2nd display.
- Each device has separate settings.

### STOPBIT – Stop bits RS232C

This menu topic allows you to set the stop bits of the transmitted data to different RS232C serial receivers.

<b>1 BIT</b>	1 Stop bit ( <b>Factory setting</b> )
<b>2 BITS</b>	2 Stop bits

### HD.SHK – Handshake RS232C

This menu topic allows you to match the data transmission to different RS232C serial receivers.

<b>XON.XOFF</b>	Software handshake (XON/XOFF) ( <b>Factory setting</b> )
<b>RTS.CTS</b>	Hardware handshake (RTS/CTS)
<b>OFF</b>	No handshake



#### Note

- Not visible for 2nd display.
- Each device has separate settings.

### RS.TX.E.O.L. – End of line RS232C

This menu topic allows you to set the end of line character of the outgoing transmitted data to different RS232C serial receivers.

<b>CR LF</b>	Carriage Return followed by Line feed (ASCII-Codes 013 + 010) ( <b>Factory setting</b> )
<b>CR</b>	Carriage Return (ASCII-Code 013)
<b>LF</b>	Line feed (ASCII-Code 010)
<b>TAB</b>	Horizontal tab (ASCII-Code 009) (only visible if <b>PC-DIR.</b> is selected)



#### Note

- Not visible for 2nd display.
- Each device has separate settings.

### RS.CHAR – Char set RS232C

This menu topic allows you to set the character set of the transmitted data to different RS232C serial receivers.

<b>IBM.DOS</b>	Char set IBM/DOS ( <b>Factory setting</b> )
<b>ANSI.WIN</b>	Char set ANSI/WINDOWS



#### Note

- Not visible for 2nd display.
- Each device has separate settings.

### INTERVL. – Print key simulation

This menu topic allows you to activate a simulation of the  key. **INTERVL.** simulates pressing the print key every x seconds.

Range:	0 to 65535 seconds
0 sec:	Disables the print key simulation

**Factory setting:** 0 sec

The executed action is according to the configuration of the print key, see interface setting.



## 6 Applications

### 6.1 Piece counting

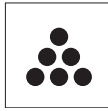

The **Piece counting** application allows you to determine the number of pieces put on the weighing pan.

- 1 Press and hold  $\Delta\Delta/F$  to call-up **APP.LIST**.
- 2 Select application **COUNT** by scrolling with  $\curvearrowright$ .
- 3 Press  $\leftarrow$  to activate the function.

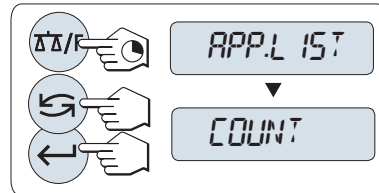

**Piece counting first requires the setting of a reference weight, there are 4 possibilities**

- **A** Setting the reference **by multiple pieces with fix reference values**.
- **B** Setting the reference **by multiple pieces with variable reference values**.
- **C** Setting the reference **for 1 piece in weighing mode**.
- **D** Setting the reference **for 1 piece in manual mode**.

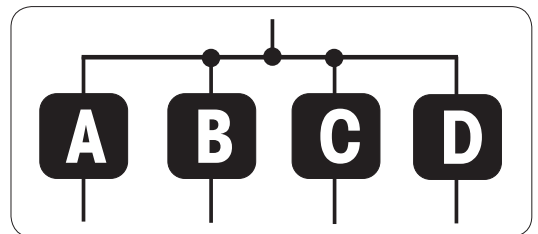

**Setting the reference by multiple pieces with fix reference values**

- 1 Select a number of reference pieces by scrolling with  $\curvearrowright$ . Possible numbers\* are 5, 10, 20 and 50.
- 2 Press  $\rightarrow 0 \leftarrow$  to zero the balance. If using: place empty container on the weighing pan and press  $\rightarrow T \leftarrow$  to tare the balance.
- 3 Add the selected number of reference pieces to container.
- 4 Press  $\leftarrow$  to confirm.

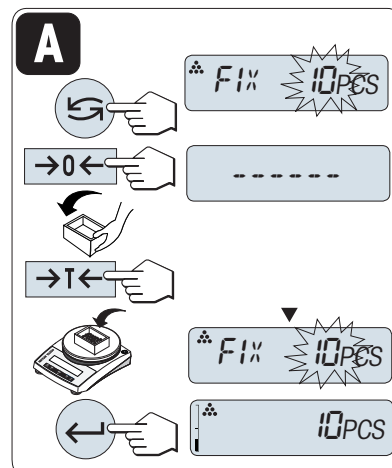

**Legal-for-trade**

\* with approved balances in selected countries: min 10.

### Setting the reference by multiple pieces with variable reference values

- 1 Select **VAR.REF** by scrolling with ↻.
- 2 Press ↵ to confirm.
- 3 Select a number of reference pieces by scrolling up + key or down - key. Possible numbers\* are 1 to 999.
- 4 Press →0← to zero the balance. If using: place empty container on the weighing pan and press →T← to tare the balance.
- 5 Add the selected number of reference pieces to container.
- 6 Press ↵ to confirm.

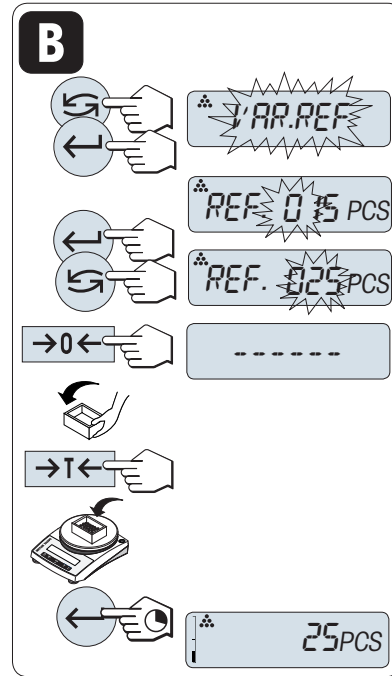

### Legal-for-trade

\* with approved balances in selected countries: min 10.

### Setting the reference for one piece in weighing mode



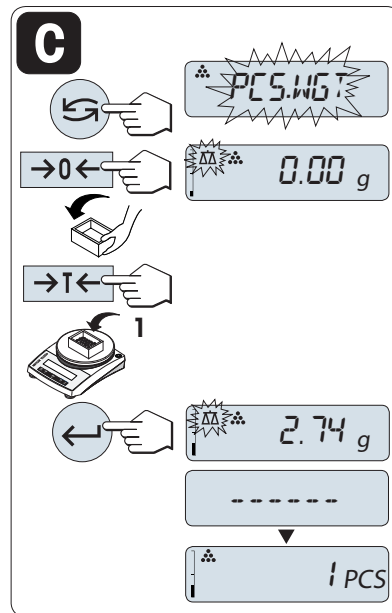

- 1 Select **PCS.WGT** by scrolling with ↻.
- 2 Press →0/T← to zero the balance. If using: place empty container on the weighing pan and press →0/T← to tare the balance.
- 3 Add one reference piece to container.
  - ➔ The weight of one piece is displayed.
- 4 Press ↵ to confirm.



### Legal-for-trade

With approved balances, this setting is not available in selected countries.

### Setting the reference for one piece in manual mode

- 1 Select **PCS.WGT** by scrolling with .
- 2 Press  to confirm.
- 3 Enter the final reference one piece weight.
- 4 Press  to select a digit (cyclically from left to right).
  - ➔ The selected digit is blinking.
- 5 Press  to change the digit.
- 6 Press and hold  to confirm.

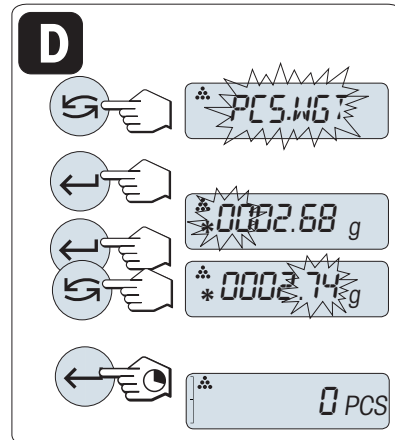

### Legal-for-trade

With approved balances, this setting is not available in selected countries.



#### Note

By not pressing any key within 60 seconds, or by pressing and holding **C**, the balance returns to the previous active application.

#### On completion of the setting procedure, your balance is ready.

- The **RECALL** value is displayed with an asterisk (\*) and icon **M** and can not be printed.
- Take into account minimum values: min. reference weight = 10d (10 digits), min. piece weight\* = 1d (1 digit)!
  - \* with approved balances in selected countries: min 3e
- The current reference weight remains stored until the reference setting is changed.

#### Terminate the application

Press and hold /F to terminate the current application.

## 6.2 Percent weighing

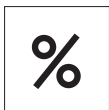

The **Percent weighing** application allows you to check a sample weight as percentage to a reference target weight.

- 1 Press and hold  $\Delta\Delta/F$  to call-up **APP.LIST**.
- 2 Select application **PERCENT** by scrolling with  $\leftarrow$ .
- 3 Press  $\leftarrow$  to activate the function.

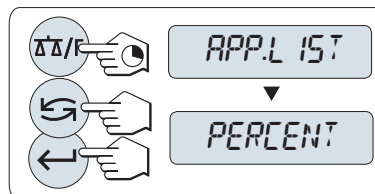

**Percent weighing first requires the setting of a reference weight that should corresponds to 100%, there are 2 possibilities**

- **A** Setting the reference **in manual mode (enter 100%)**.
- **B** Setting the reference **in weighing mode (weigh 100%)**.

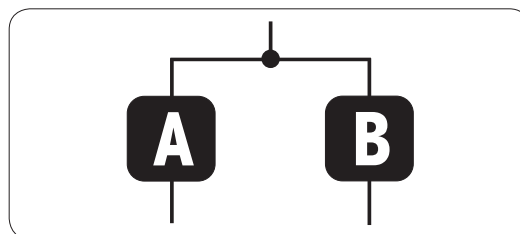

### Setting the reference by manual mode (enter 100%)

- 1 Press  $\leftarrow$  to activate manual mode.
- 2 Press  $\leftarrow$  to select a digit (cyclically from left to right).  
→ The selected digit is blinking.
- 3 Press  $\leftarrow$  to change the digit.
- 4 Press and hold  $\leftarrow$  to confirm.

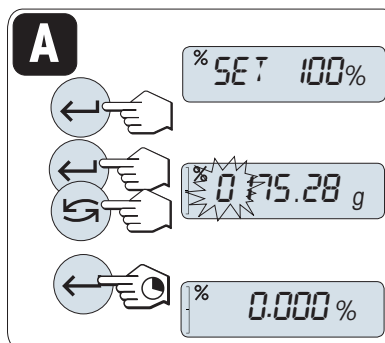

### Setting the reference by weighing mode (weigh 100%)

- 1 Press  $\rightarrow 0 \leftarrow$  to zero the balance. If using: place empty container on the weighing pan and press  $\rightarrow T \leftarrow$  to tare the balance.
- 2 Load the reference weight (100%). Reference weight must be at least +/- 10d.
- 3 Press  $\leftarrow$  to confirm.

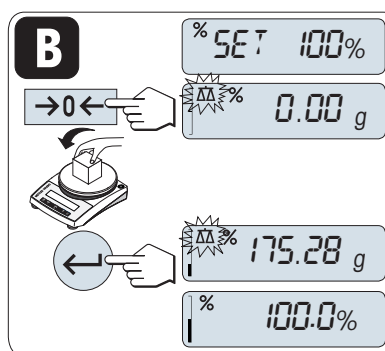

#### Note

By not pressing any key within 60 seconds, or by pressing and holding **C**, the balance returns to the previous active application.

**On completion of the setting procedure, your balance is ready.**

### Switching between percent and weight display

- Press  key at any time to switch the display between percent display, weighing unit **UNIT 1**, **RECALL** value (if activated) and weighing unit **UNIT 2** (if different from **UNIT 1**).
- The **RECALL** value is displayed with an asterisk (\*) and icon **M** and can not be printed.
- The current set weight remains stored until it is redetermined.

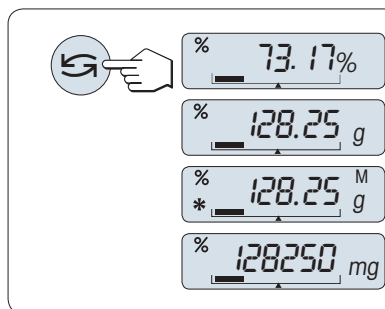

### Terminate the application

Press and hold /F to terminate the current application.

## 6.3 Check weighing

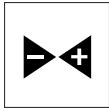

The **Check weighing** application allows you to check the deviation of a sample weight within a tolerance limit to a reference target weight.

- 1 Press and hold  $\Delta\Delta/F$  to call-up **APP.LIST**.
- 2 Select application **CHECK** by scrolling with  $\curvearrowright$ .
- 3 Press  $\leftarrow$  to activate the function.

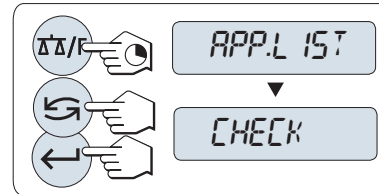

**Step 1: Check weighing first requires the setting of a reference weight that should corresponds to the nominal weight, there are 2 possibilities**

- **1A** Setting the reference **in manual mode** (enter nominal weight).
- **1B** Setting the reference **in weighing mode** (weigh nominal weight).

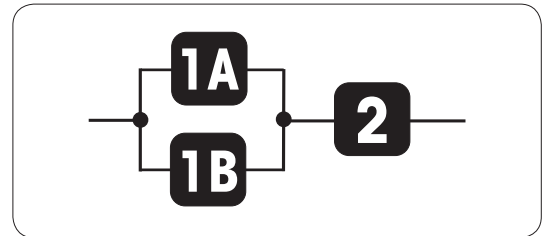

**Step 2: Check weighing needs the upper and lower limits**

- **2** Setting the **upper and lower limits in percentage**.

**Setting the reference by manual mode (enter nominal weight)**

- 1 Press  $\leftarrow$  to activate manual mode.
- 2 Select the reference target weight.
- 3 Press  $\leftarrow$  to select a digit (cyclically from left to right).  
→ The selected digit is blinking.
- 4 Press  $\curvearrowright$  to change the digit.
- 5 Press and hold  $\leftarrow$  to confirm.

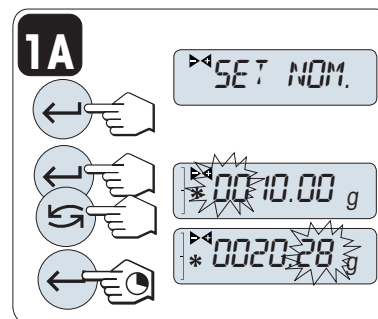

**Setting the reference in weighing mode (weigh nominal weight)**

- 1 Press  $\rightarrow 0 \leftarrow$  to zero the balance. If using: place empty container on the weighing pan and press  $\rightarrow T \leftarrow$  to tare the balance.
- 2 Load the nominal weight.
- 3 Press  $\leftarrow$  to confirm.

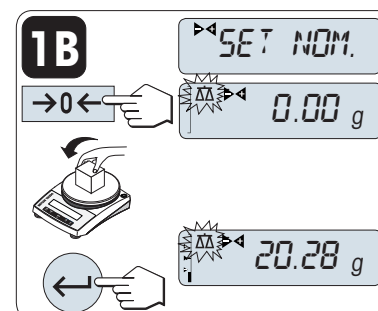

### Setting the upper and lower limits (in percentage)

- 1 Press to start setting.
- 2 Press to confirm the default limit of +/- 2.5% or enter the limit value.
- 3 Press to select a digit (cyclically from left to right).  
➔ The selected digit is blinking.
- 4 Press to change the digit.
- 5 Press and hold to confirm.

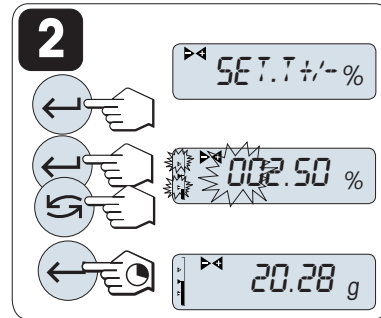

### Note

By not pressing any key within 60 seconds, or by pressing and holding **C**, the balance returns to the previous active application.

The nominal weight must be at least 10 digit.

**On completion of the setting procedure, your balance is ready.**

### Weighing-in-aid

The weighing-in-aid helps you quickly determine the position of the sample weight regarding the tolerance.

- **1** Lower limit
- **2** Target weight
- **3** Upper limit

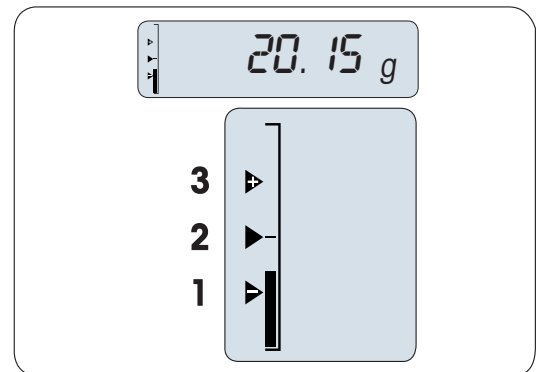

### Terminate the application

Press and hold to terminate the current application.

## 6.4 Statistics



The **Statistics** application allows you to generate statistics of a series of weighing values. 1 to 999 values are possible.

- 1 Press and hold  $\Delta\Delta/F$  to call-up **APP.LIST**.
- 2 Select application **STAT.** by scrolling with  $\curvearrowright$ .
- 3 Press  $\leftarrow$  to activate the function.

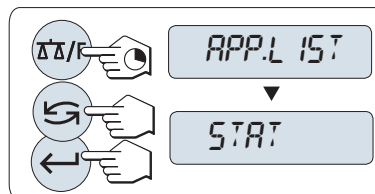

### Memory clear question

If the memory is already cleared (sample counter is 0) the memory clear question will not be displayed.

- 1 To continue the last statistics, press  $\leftarrow$  to confirm **CLR.M:NO**.
- 2 For a new statistical evaluation clear the memory. Press  $\curvearrowright$  to select **CLR.M:YES** and press  $\leftarrow$  to confirm.

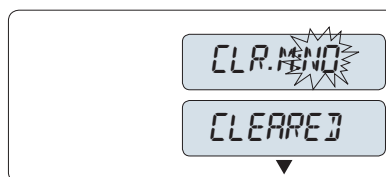

### Weighing the first sample weight

- 1 Press  $\rightarrow 0 \leftarrow$  to zero the balance.
- 2 Load the first sample weight.
- 3 Press  $\leftarrow$ .
  - ➔ The display shows the sample count - 1 - and the current weight is stored as sample and the weight is printed out.
- 4 When the sample counter is displayed you may press and hold **C** to undo (drop) this sample.
- 5 Unload the first sample weight.

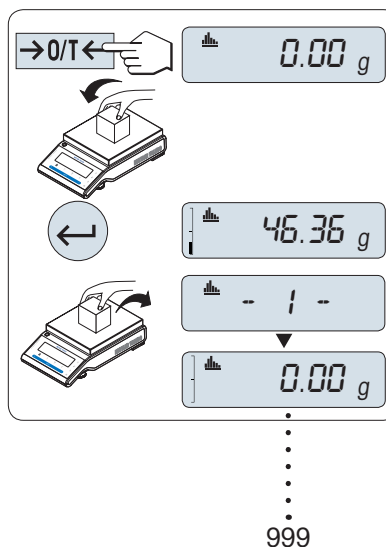

### Weighing further sample weights

The same procedure as for the first sample weight.

- 1...999 samples are possible.
- The next value will be accepted if the sample weight is in the range 70% –130% of the current average value. **OUT OF RANGE** will be displayed if the sample is not accepted.

### Results

- Press  $\text{≡}$ , if the numbers of sample are greater than or equal to 2.
  - ➔ The results are displayed and printed.





































### Displayed results

- 1 Press  $\leftarrow$  to show the next statistical value.
- 2 Press and hold **C** to cancel displaying results and to continue weighing next sample.

0.5 seconds

number of samples	 <b>N</b>		 <b>5</b>	
average	 <b>x̄</b>		 <b>50.530 g</b>	
standard deviation	 <b>S.DEV</b>		 <b>3.961 g</b>	
relative standard deviation	 <b>S.REL</b>		 <b>7.84 %</b>	
lowest value (minimum)	 <b>MIN</b>		 <b>46.36 g</b>	
highest value (maximum)	 <b>MAX</b>		 <b>55.81 g</b>	
different between the minimum and the maximum	 <b>DIFF</b>		 <b>9.45 g</b>	
sum of all values	 <b>SUM</b>		 <b>252.65 g</b>	

### Terminate the application

Press and hold  $\Delta\Delta/F$  to terminate the current application.

## 6.5 Totaling



The **TOTALING** application allows you to weigh in different samples to add their weight values and to totalize them. 1 to 999 samples are possible.

- 1 Press and hold  $\Delta\Delta/F$  to call-up **APP.LIST**.
- 2 Select application **TOTAL** by scrolling with  $\curvearrowright$ .
- 3 Press  $\leftarrow$  to activate the function.

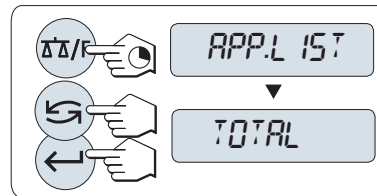

### Memory clear question

If the memory is already cleared (sample counter is 0) the memory clear question will not be displayed.

- 1 To continue the totaling evaluation, press  $\leftarrow$  to confirm **CLR.M:NO**.
- 2 For a new totaling evaluation clear the memory. Press  $\curvearrowright$  to select **CLR.M:YES** and press  $\leftarrow$  to confirm.



### Weighing in the sample weight

- 1 Press  $\rightarrow 0 \leftarrow$  to zero the balance. If using: place empty container on the weighing pan and press  $\rightarrow T \leftarrow$  to tare the balance.
- 2 Load the first sample weight.
- 3 Press  $\leftarrow$ .
  - ➔ The display shows the sample count - 1 - and the current weight is stored.
- 4 When the sample counter is displayed you may press and hold **C** to undo (drop) this sample.
- 5 Unload the first sample weight.
  - ➔ The display shows zero.

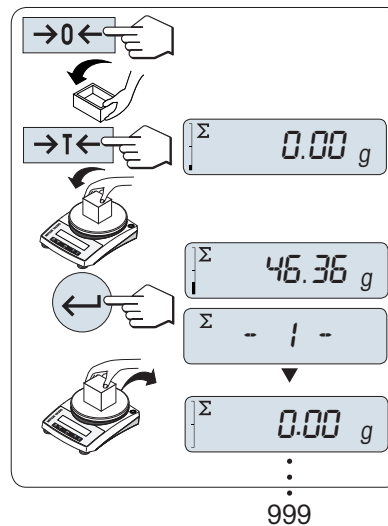

### Weighing in further sample weights

The same procedure as for the first sample weight.

- 1...999 samples are possible.

## Results

- Press  if the numbers of sample are greater than or equal to 2.
  - ➔ The results are displayed and printed.

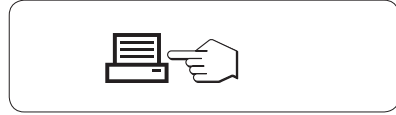

## Displayed results

- 1 Press  to show the totalized value.
- 2 Press and hold **C** to cancel.

0.5 seconds

number of samples  $\Sigma N$   $\rightarrow$   $* \Sigma 879$   $\leftarrow$

totalized value  $\Sigma TOTAL$   $\rightarrow$   $* \Sigma 8789.79_g$   $\leftarrow$

## Terminate the application

Press and hold  to terminate the current application.

## 6.6 Multiplication factor weighing



The **Multiplication factor weighing** application allows you to multiply the weight value (in grams) by a predefined factor (result = factor \* weight) and have it calculated to a predefined number of decimal places.

- 1 Press and hold  $\Delta\Delta/F$  to call-up **APP.LIST**.
- 2 Select application **FACTOR.M** by scrolling with  $\curvearrowright$ .
- 3 Press  $\leftarrow$  to activate the function.

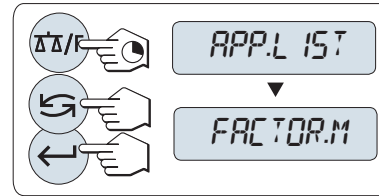

### Setting the factor value

Zero for multiplication factor value is outside the allowed range, the error message **FACTOR OUT OF RANGE** will be displayed.

- 1 Press  $\leftarrow$  to execute **SET.F.MUL**.
  - ➔ Either the factor 1 appears as default value or the factor that was saved most recently.
- 2 Press  $\leftarrow$  to select a digit (cyclically from left to right).
  - ➔ The selected digit is blinking.
- 3 Press  $\curvearrowright$  to change the digit.
- 4 Press and hold  $\leftarrow$  to confirm (no automatic acceptance).

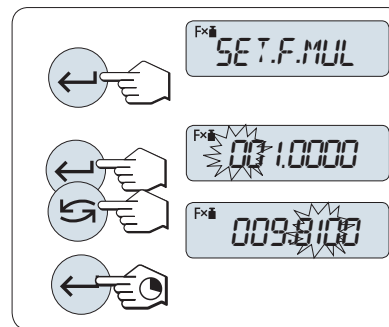

### Setting the step value

**SET.STEP** appears on the display, and the program changes automatically to allow the display increments to be entered. The smallest possible display increment appears as default value, or the last value that was saved.

The allowed range for the step depends on the factor and the resolution of the balance. If it is outside the allowed range, the error message **STEP OUT OF RANGE** will be displayed.

- 1 Press  $\leftarrow$  to execute **SET.STEP**.
- 2 Press  $\leftarrow$  to select a digit (cyclically from left to right).
  - ➔ The selected digit is blinking.
- 3 Press  $\curvearrowright$  to change the digit.
- 4 Press and hold  $\leftarrow$  to confirm (no automatic acceptance).

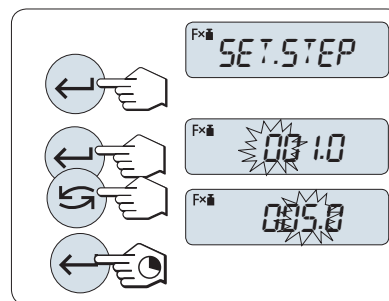

#### Note

By not pressing any key within 60 seconds, or by pressing and holding **C**, the balance returns to the previous active application.

**On completion of the setting procedure, your balance is ready.**

### **Weighing procedure**

- 1 Press **→0←** to zero the balance.
- 2 Load sample weight.
- 3 Read the result.
  - ➔ The appropriate calculation is then made using the weight of sample and the selected factor, the result being displayed with the selected display step. No units are displayed.
- 4 Unload sample weight.

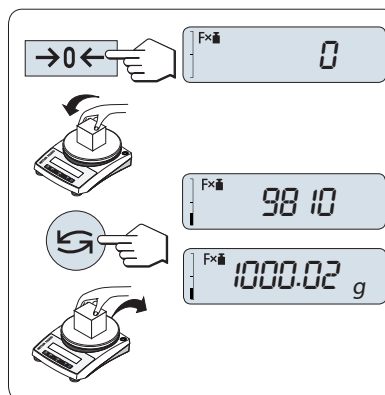

### **Toggling between displaying the calculated value and the measured weight**

- Press **↺** key at any time to switch the display between percent display, weighing unit **UNIT 1**, **RECALL** value (if activated) and weighing unit **UNIT 2** (if different from **UNIT 1**).

### **Terminate the application**

Press and hold **↵/F** to terminate the current application.

## 6.7 Division factor weighing



The **Division factor weighing** divide a predefined factor by the weight value (in grams) (result = factor / weight) and have it rounded to a predefined number of decimal places.

- 1 Press and hold  $\Delta\Delta/F$  to call-up **APP.LIST**.
- 2 Select application **FACTOR.D** by scrolling with  $\curvearrowright$ .
- 3 Press  $\leftarrow$  to activate the function.

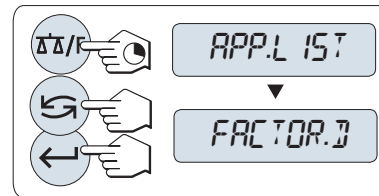

### Setting the factor value

Zero for division factor value is outside the allowed range, the error message **FACTOR OUT OF RANGE** will be displayed.

- 1 Press  $\leftarrow$  to execute **SET.F.DIV**.
  - ➔ Either the factor 1 appears as default value or the factor that was saved most recently.
- 2 Press  $\leftarrow$  to select a digit (cyclically from left to right).
  - ➔ The selected digit is blinking.
- 3 Press  $\curvearrowright$  to change the digit.
- 4 Press and hold  $\leftarrow$  to confirm (no automatic acceptance).

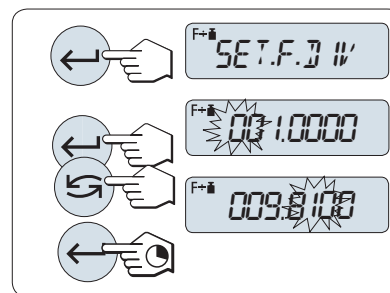

### Setting the step value

**SET.STEP** appears on the display, and the program changes automatically to allow the display increments to be entered. The smallest possible display increment appears as default value, or the last value that was saved. The allowed range for the step depends on the factor and the resolution of the balance. If it is outside the allowed range, the error message **STEP OUT OF RANGE** will be displayed.

- 1 Press  $\leftarrow$  to execute **SET.STEP**.
- 2 Press  $\leftarrow$  to select a digit (cyclically from left to right).
  - ➔ The selected digit is blinking.
- 3 Press  $\curvearrowright$  to change the digit.
- 4 Press and hold  $\leftarrow$  to confirm (no automatic acceptance).

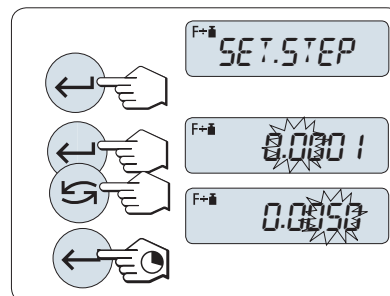

### Note

By not pressing any key within 60 seconds, or by pressing and holding **C**, the balance returns to the previous active application.

**On completion of the setting procedure, your balance is ready.**

### Weighing procedure

- 1 Press **→0←** to zero the balance.
- 2 Load sample weight.
- 3 Read the result.
  - ➔ The appropriate calculation is then made using the weight of sample and the selected factor, the result being displayed with the selected display step. No units are displayed.
- 4 Unload sample weight.

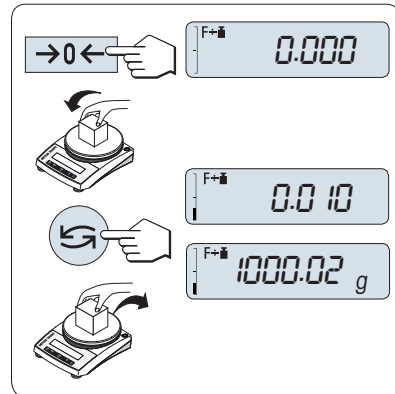

### Toggling between displaying the calculated value and the measured weight

- Press **↺** key at any time to switch the display between percent display, weighing unit **UNIT 1**, **RECALL** value (if activated) and weighing unit **UNIT 2** (if different from **UNIT 1**).

### Terminate the application

Press and hold **ΔΔ/F** to terminate the current application.

## 7 Communication with Peripheral Devices

### 7.1 Send weight value via RS232 to a computer using PC-Direct

The PC-Direct function of the balance allows you to transfer weight values from the balance to a Windows application. The weight value displayed on the balance is transferred to the cursor position in, e.g., Excel or Word.

The data is transferred via the serial RS232 interface.

The weight value is transferred without the unit.

#### Requirements

- Computer with one of the following Microsoft Windows® 32-bit/64-bit operating systems: Windows 7 (SP1), Windows 8 or Windows 10
- Windows application, e.g., Excel
- Serial interface RS232, or RS232-to-USB converter
- RS232 cable to connect the balance to the computer
- Administrator rights to install the **SerialPortToKeyboard software**

#### Transfer values

- The **SerialPortToKeyboard software** is installed on your computer.
- 1 Start the **SerialPortToKeyboard software**.
  - 2 Select the correct COM port used by the balance.
  - 3 Configure all settings according to the user requirements.
    - ➔ The weighing result (and additional data) is transferred to the computer program automatically.

#### 7.1.1 Installing SerialPortToKeyboard software

The operation of PC-Direct via serial port RS232C requires the installation of **SerialPortToKeyboard** on your host computer. The file **SerialPortToKeyboard** can be found on [www.mt.com/labweighing-software-download](http://www.mt.com/labweighing-software-download). If you have any questions, please contact a METTLER TOLEDO representative.

#### Download SerialPortToKeyboard

- 1 Connect to the internet.
- 2 Go to the site [www.mt.com/labweighing-software-download](http://www.mt.com/labweighing-software-download).
- 3 Click **Download Software and Instructions** in section **SerialPortToKeyboard software for Advanced and Standard level laboratory balances**.
  - ➔ A pop-up window with interactions appears.
- 4 Click, e.g., **Open**.
  - ➔ The extract screen appears.
- 5 Extract the file **SerialPortToKeyboard\_V\_x.xx\_installer\_and\_instructions.zip** to your specified location.
- 6 Right-click on the downloaded installation program **SerialPortToKeyboard\_V\_x.xx.exe** and select **Run as Administrator**.
- 7 If a safety warning appears, confirm windows to perform the installation.
- 8 Click **Next** and follow the installer's instructions.

#### Checking operation

- 1 Start **SerialPortToKeyboard** (RS232C)
- 2 Start Excel (or another application) on the computer.
- 3 Activate a cell in Excel.



## 7.1.2 Software settings

- 1 Select the serial port **COM** for the connection with the balance.
- 2 Set the **Baud Rate** to **9600**.
- 3 Activate **Connect**.
  - Closing the window terminates the session.

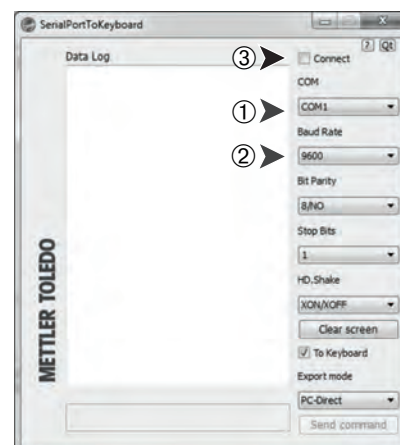

According to your selected **PC-DIR.** option, the displayed values will appear e.g., in the column one after the other one in the different rows.

## 7.1.3 Balance settings

Balance interface settings, **see** chapter "Interface menu".

### Topic RS232

- Set **PC-DIR.** and select the most appropriate option for the desired weighing result.

### Topic RS.TX.E.O.L./RS E.O.L.

- 1 Set **TAB** to write into the same row (e.g. in Excel).
- 2 Set **CR LF** to write into the same column (e.g. in Excel).
- 3 Save changes.

## 7.2 Collecting measurement results and balance details with EasyDirect Balance

EasyDirect Balance from METTLER TOLEDO is a computer software to collect, analyze, store and export measurement results and balance details from up to 10 balances. EasyDirect Balance supports all Advanced and Standard Level Laboratory Balances and many legacy models from METTLER TOLEDO. For more information and to download a trial version of the software, please refer to [www.mt.com/EasyDirectBalance](http://www.mt.com/EasyDirectBalance).

The balance is connected to the computer via RS232.

### Connecting the balance to EasyDirect Balance

- The balance is connected to the computer via a RS232 cable.
  - The correct driver for the RS232 cable is installed on your computer.
  - EasyDirect Balance is installed on your computer.
- 1 Open EasyDirect Balance on your computer.
  - 2 In the program, click the "Help"-button.
    - ➔ The EasyDirect Balance Reference Manual opens.
  - 3 Search the EasyDirect Balance Reference Manual for your balance type.
  - 4 Configure the settings on the balance as described.
  - 5 Follow the instructions on how to add the balance to EasyDirect Balance.
    - ➔ The balance connects to EasyDirect Balance.

## Collecting measurement results

The collection of measurement results depends on the balance settings.

- The printer setting on the balance is, e.g., **PRT.STAB**.
- 1 Place a sample on your balance.
- 2 Press the  key.
- ➔ The measurement result is transferred to EasyDirect Balance.

## Data available to EasyDirect Balance

		RS232
<b>Balance details</b>	Balance model	✓
	Balance ID	✓
	Balance serial number	✓
	Balance capacity	✓
	Balance readability	–
	Level status	–
	Adjustment status	–
	Service status	–
	Connection status	–
	<b>Measurement results</b>	Gross/Tare/Net weight
Unit 1 and Unit 2 (incl. pcs, %)		✓
Stability condition		✓
Date and Time		✓
Sample and task IDs		✓
Target and tolerances		–
User name		–
Application specific results and parameters		–
<b>Supported activities</b>	Weighing	✓
	Counting	✓
	Percent weighing	✓
	Factor weighing	✓
	Check weighing	–
	Dynamic weighing	–
	Formulation	–
	Totaling	–
	Back-weighing	–
	Differential weighing	–
	Density	–
	Adjustments	–
	Routine test	–
	Repeatability test	–

## 8 Maintenance

To guarantee the functionality of the balance and the accuracy of the weighing results, a number of maintenance actions must be performed by the user.

### 8.1 Maintenance tasks

Maintenance action	Recommended interval	Remarks
Performing an adjustment	<ul style="list-style-type: none"><li>• Daily</li><li>• After cleaning</li><li>• After leveling</li><li>• After changing the location</li></ul>	see "Adjusting the balance"
Cleaning	<ul style="list-style-type: none"><li>• After every use</li><li>• After changing the sample</li><li>• Depending on the degree of pollution</li><li>• Depending on your internal regulations (SOP)</li></ul>	see "Cleaning the balance"
Performing routine test / repeatability test.	<ul style="list-style-type: none"><li>• After cleaning</li><li>• After assembling the balance</li><li>• Depending on your internal regulations (SOP)</li></ul>	see "Putting into operation after cleaning"

### 8.2 Cleaning

#### 8.2.1 Cleaning the balance



#### NOTICE

##### Damage due to improper cleaning

Improper cleaning can damage the load cell or other essential parts.

- 1 Do not use any cleaning agents other than the ones specified in the "Reference Manual" or "Cleaning Guide".
- 2 Do not spray or pour liquids on the instrument. Always use a moistened lint-free cloth or a tissue.
- 3 Always wipe out from inside to outside of the instrument.



For further information on cleaning a balance, consult "8 Steps to a Clean Balance".

► [www.mt.com/lab-cleaning-guide](http://www.mt.com/lab-cleaning-guide)

##### Cleaning around the balance

- Remove any dirt or dust around the balance and avoid further contaminations.

##### Cleaning the removable parts



- Clean the removed part with a damp cloth or a tissue and a mild cleaning agent.

##### Cleaning the balance

- 1 Disconnect the balance from the AC/DC adapter.
- 2 Use a lint-free cloth moistened with a mild cleaning agent to clean the surface of the balance.
- 3 Remove powder or dust at first with a disposable tissue.

- 4 Remove sticky substances with a damp lint-free cloth and a mild solvent.

## 8.2.2 Putting into operation after cleaning

- 1 Reassemble the balance.
- 2 Press  to switch on the balance.
- 3 Warm up the balance. Wait 1 h for the acclimatization before starting the tests.
- 4 Check the level status, level the balance if necessary.
- 5 Perform an adjustment.
- 6 Perform a routine test according to the internal regulations of your company. METTLER TOLEDO recommends performing a repeatability test after cleaning the balance.
- 7 Press  to zero the balance.
  - ➔ The balance is ready to be used.

### See also

-  Adjusting the balance ▶ Page 17

## 9 Troubleshooting

Possible errors with their cause and remedy are described in the following chapter. If there are errors that cannot be corrected through these instructions, contact METTLER TOLEDO.

### 9.1 Error messages

Error message	Possible cause	Diagnostic	Remedy
<b>NO STABILITY</b>	Vibrations at the workplace.	Place beaker with tap water on the weighing table. Vibrations cause ripples on the water surface.	<ul style="list-style-type: none"> <li>Protect weighing location against vibrations (vibration absorber, etc.).</li> <li>Set weighing parameters coarser (change <b>ENVIRON.</b> from <b>STABLE</b> to <b>STANDARD</b> or even <b>UNSTABLE</b>).</li> <li>Find a different weighing location (by agreement with customer).</li> </ul>
	Draft due to open window or similar.	Make sure window is closed.	<ul style="list-style-type: none"> <li>Close window.</li> <li>Set weighing parameters coarser (change <b>ENVIRON.</b> from <b>STABLE</b> to <b>STANDARD</b> or even <b>UNSTABLE</b>).</li> </ul>
	The location is not suitable for weighing.	–	Check and observe the requirements for the location, refer to "Selecting the location".
	Something is touching the weighing pan.	Check for touching parts or dirt.	Remove touching parts or clean the balance.
<b>WRONG ADJUSTMENT WEIGHT</b>	Wrong adjustment weight.	Check weight.	Place correct weight on the weighing pan.
<b>REFERENCE TOO SMALL</b>	Reference for piece counting too small.	–	Increase reference weight.
<b>EEPROM ERROR - PLEASE CONTACT CUSTOMER SERVICE</b>	Data in EEPROM damaged.	–	Please contact your METTLER TOLEDO customer service.
<b>WRONG CELL DATA - PLEASE CONTACT CUSTOMER SERVICE</b>	Defect load cell data.	–	Please contact your METTLER TOLEDO customer service.
<b>NO STANDARD ADJUSTMENT - PLEASE CONTACT CUSTOMER SERVICE</b>	–	–	Please contact your METTLER TOLEDO customer service.
<b>PROGRAM MEMORY DEFECT - PLEASE CONTACT CUSTOMER SERVICE</b>	–	–	Please contact your METTLER TOLEDO customer service.

Error message	Possible cause	Diagnostic	Remedy
<b>TEMP SENSOR DEFECT - PLEASE CONTACT CUSTOMER SERVICE</b>	AC/DC adapter connected to power before connecting to the balance. Temperature sensor of load cell defect.	–	Remove the AC/DC adapter from the power and connect first to the balance before connecting to the power if persist please contact your METTLER TOLEDO customer service.
<b>WRONG LOAD CELL BRAND - PLEASE CONTACT CUSTOMER SERVICE</b>	Wrong load cell installed.	–	Please contact your METTLER TOLEDO customer service.
<b>WRONG TYPE DATA SET - PLEASE CONTACT CUSTOMER SERVICE</b>	Wrong type data set.	–	Please contact your METTLER TOLEDO customer service.
<b>BATTERY BACKUP LOST - CHECK DATE TIME SETTINGS</b>	Backup battery/capacitor is empty. This battery/capacitor ensures that the date and time are not lost when the balance is disconnected from power.	The battery/capacitor provides enough power for approximately 2 days when having the balance not connected to the power supply.	Connect the balance to the power supply for charging the battery (e.g., during the night) or contact METTLER TOLEDO customer service.
<b>WRONG POWER ADAPTOR DETECTED – PLEASE CORRECT YOUR POWER ADAPTOR</b>	Wrong or defective AC power adapter.	–	Use correct power adapter or replace the power adapter.
<b>ABOVE INITIAL ZERO RANGE</b>	Wrong weighing pan. Pan is not empty.	Check weighing pan.	Mount correct weighing pan or unload weighing pan.
<b>BELOW INITIAL ZERO RANGE</b>	Wrong weighing pan. Pan is missing.	Check weighing pan.	Mount correct weighing pan.
<b>MEM FULL</b>	Memory full.	–	Clear the memory by finishing all applications where a measurement is ongoing.
<b>FACTOR OUT OF RANGE</b>	Factor is outside the allow range.	–	Select a new factor.
<b>STEP OUT OF RANGE</b>	Step is outside the allow range.	–	Select a new step.
<b>OUT OF RANGE</b>	Sample weight is outside the allow range.	–	Unload the pan and load a new sample weight.

## 9.2 Error symptoms

Error symptom	Possible cause	Diagnostic	Remedy
Display is dark	Instrument is switched off.	–	Switch on the instrument.
	Power plug not connected.	Check	Connect power cable to power supply.
	Power supply not connected to balance.	Check	Connect power supply.
	Power supply is faulty.	Check/test	Replace power supply.

Error symptom	Possible cause	Diagnostic	Remedy
	Wrong power supply.	Check that input data on type plate match the power supply values.	Use proper power supply.
	Connector socket on balance is corroded or faulty.	Check	Please contact your METTLER TOLEDO customer service.
	Display is faulty.	Replace display.	Please contact your METTLER TOLEDO customer service.
Operation Keys do not work	Keypad is defect.	Replace the keypad.	Please contact your METTLER TOLEDO customer service.
The value drifts into plus or minus	Room, environment not suitable.	–	<b>Environmental recommendations</b> <ul style="list-style-type: none"> <li>Windowless, non air-conditioned room, e.g., basement.</li> <li>Only one person in the weighing room.</li> <li>Sliding doors. Standard doors cause pressure changes.</li> <li>No draft in weighing room (check with suspended threads).</li> <li>No air conditioning (temperature oscillates, draft).</li> <li>Acclimatize balance, take dummy measurements.</li> <li>Instrument uninterruptedly connected to the power supply (24h per day).</li> </ul>
	Direct sunlight or other heat source.	Is any sun shade (blinds, curtains, etc.) available?	Select location according to "Selecting the location" (customer responsibility).
	Weighing sample absorbs moisture or evaporates moisture.	<ul style="list-style-type: none"> <li>Is the weighing result with a test weight stable?</li> <li>Sensitive weighing samples, e.g., paper, cardboard, wood, plastic, rubber, liquids.</li> </ul>	<ul style="list-style-type: none"> <li>Use aids.</li> <li>Cover weighing sample.</li> </ul>
	Weighing sample is electrostatically charged.	<ul style="list-style-type: none"> <li>Is the weighing result with a test weight stable?</li> </ul>	<ul style="list-style-type: none"> <li>Increase air humidity in weighing chamber (45% - 50%).</li> <li>Use ionizer.</li> </ul>

Error symptom	Possible cause	Diagnostic	Remedy
		<ul style="list-style-type: none"> <li>Sensitive weighing samples, e.g., plastic, powder, insulating materials.</li> </ul>	
	Weighing sample is hotter or colder than the air in the weighing chamber.	Weighing operation with test weight does not show this effect.	Bring weighing sample to room temperature before weighing.
	Instrument has not yet reached thermal equilibrium.	<ul style="list-style-type: none"> <li>Was there a power outage?</li> <li>Was power supply disconnected?</li> </ul>	<ul style="list-style-type: none"> <li>Acclimatize instrument for at least 1 hour. Depending on climatic conditions, extend this period accordingly.</li> <li>Instrument switched on for at least 1 hour, refer to "General data"</li> </ul>
Display shows overload or underload	The weight on the weighing pan exceeds the weighing capacity of the instrument.	Check weight.	Reduce the weight on the weighing pan.
	Wrong weighing pan.	Slightly lift or press weighing pan. The weight display appears.	Use proper weighing pan.
	No weighing pan.	–	Install weighing pan.
	Incorrect zero point at switch-on.	–	<ul style="list-style-type: none"> <li>Switch off balance.</li> <li>Disconnect and reconnect power cable.</li> </ul>
Display flashes 0.00	Loose cables.	Check all cable connections.	Connect all cables. Please contact your METTLER TOLEDO customer service if the problem persists.
Taring not possible	Vibrations at the workplace.	Display unstable.	Press Tare again.
		Place beaker with tap water on the weighing table. Vibrations cause ripples on the water surface.	<ul style="list-style-type: none"> <li>Protect weighing location against vibrations (vibration absorber, etc.).</li> <li>Set weighing parameters coarser (change <b>ENVIRON.</b> from <b>STABLE</b> to <b>STANDARD</b> or even <b>UNSTABLE</b>).</li> <li>Find a different weighing location (by agreement with customer).</li> </ul>



### 9.3 Status icons

Icon	Status description	Diagnostic	Remedy
	Service due.	<b>See</b> menu topic <b>SERV.ICON</b> in chapter "Description of menu topic" -> "Advanced menu".	Please contact your METTLER TOLEDO-Support representative.

### 9.4 Putting into operation after fixing an error

After fixing an error, perform the following steps to put the balance into operation:

- Ensure that the balance is completely reassembled and cleaned.
- Reconnect the balance to the AC/DC adapter.

## 10 Technical Data

### 10.1 General data

#### Standard power supply

AC/DC adapter:

Input: 100 – 240 V AC  $\pm$  10%, 50 – 60 Hz, 0.5 A

Output: 12 V DC, 1.0 A (with electronic overload protection)

Balance power consumption:

12 V DC, 0.84 A

Polarity:



Mean sea level:

Can be used up to 2000 m above mean sea level

If the balance is used above 2000 m mean sea level, the optional power supply must be used.

Battery operation:

8 standard AA batteries (alkaline or lithium) for 8 – 15 hours of use

#### Optional power supply

AC/DC adapter:

Input: 100 – 240 V AC  $\pm$  10%, 50 – 60 Hz, 0.8 A

Output: 12 V DC, 2.5 A (with electronic overload protection)

Cable for AC/DC adapter:

3-core, with country-specific plug

Balance power consumption:

12 V DC, 0.84 A

Mean sea level:

Can be used up to 4000 m above mean sea level

#### Protection and standards

Overvoltage category:

II

Degree of pollution:

2

Protection:

Protected against dust and water

Standards for safety and EMC:

See Declaration of Conformity

Range of application:

Use only indoors in dry locations

#### Environmental conditions

Height above mean sea level:

Depending on the power adapter (up to 2000 or 4000 m)

Ambient temperature:

Operating conditions for ordinary lab application: +10 °C to +30 °C (operability guaranteed between +5 °C and +40 °C)

Relative air humidity:

Max. 80% up to 31 °C, linearly decreasing to 50% at 40 °C, non-condensing

Warm-up time:

At least **30 minutes** after connecting the balance to the power supply. When switched on from standby, the instrument is ready for operation immediately.

#### Materials

Housing:

ABS/PC

Weighing pan:

Stainless steel X5CrNi 18-10 (1.4301)

## Model-specific data

	JL602GE	JL1502GE	JL6001GE
<b>Limit values</b>			
Capacity	620 g	1520 g	6.2 kg
Nominal load	600 g	1500 g	6 kg
Readability	10 mg	10 mg	100 mg
Repeatability	10 mg	10 mg	100 mg
Linearity deviation	30 mg	30 mg	300 mg
Eccentricity deviation (at test load)	20 mg (200 g)	200 mg (500 g)	200 mg (2000 g)
Sensitivity temperature drift <sup>2)</sup>	0.001 %/°C	0.001 %/°C	0.001 %/°C
<b>Typical values</b>			
Repeatability	7 mg	7 mg	70 mg
Linearity deviation	15 mg	15 mg	150 mg
Eccentricity deviation (at test load)	6 mg (200 g)	60 mg (500 g)	60 mg (2000 g)
Minimum weight (tolerance = 1%) <sup>3)</sup>	1.4 g	1.4 g	14 g
Settling time	2 s	2 s	1.5 s
Adjustment	External	External	External
<b>Dimensions &amp; other specifications</b>			
Balance dimensions (WxDxH)	194x225x67 mm	194x225x67 mm	194x225x67 mm
Weighing pan diameter	160 mm	160 mm	160 mm
Balance weight	1300 g	1300 g	1300 g
<b>Weights for routine testing</b>			
Weights (OIML class)	20 g (F2)/ 500 g (F2)	50 g (F2)/ 1000 g (F2)	200 g (F2)/ 5000 g (F2)
Weights (ASTM class)	20 g (ASTM 1)/ 500 g (ASTM 1)	50 g (ASTM 1)/ 1000 g (ASTM 1)	200 g (ASTM 4)/ 5000 g (ASTM 4)

<sup>2)</sup> in the temperature range 10 °C ... 30 °C

<sup>3)</sup> determined at 5% load, k = 2

	JL601GE/AED	JL1501GE/AED	JL6000GE/AED
<b>Limit values</b>			
Capacity	620 g	1520 g	6.2 kg
Nominal load	600 g	1500 g	6 kg
Readability	100 mg	100 mg	1000 mg
Repeatability	70 mg	70 mg	700 mg
Linearity deviation	50 mg	50 mg	500 mg
Eccentricity deviation (at test load)	100 mg (200 g)	100 mg (500 g)	1 g (2000 g)
Sensitivity temperature drift <sup>2)</sup>	0.001 %/°C	0.001 %/°C	0.001 %/°C
<b>Typical values</b>			
Repeatability	40 mg	40 mg	400 mg
Linearity deviation	30 mg	30 mg	300 mg
Eccentricity deviation (at test load)	30 mg (200 g)	30 mg (500 g)	300 mg (2000 g)
Minimum weight (tolerance = 1%) <sup>3)</sup>	8 g	8 g	80 g
Settling time	2 s	2 s	1.5 s
Adjustment	External	External	External
<b>Dimensions &amp; other specifications</b>			
Balance dimensions (WxDxH)	194x225x67 mm	194x225x67 mm	194x225x67 mm
Weighing pan diameter	160 mm	160 mm	160 mm
Balance weight	1300 g	1300 g	1300 g
<b>Weights for routine testing</b>			
Weights (OIML class)	20 g (F2)/ 500 g (F2)	50 g (F2)/ 1000 g (F2)	200 g (F2)/ 5000 g (F2)
Weights (ASTM class)	20 g (ASTM 1)/ 500 g (ASTM 1)	50 g (ASTM 1)/ 1000 g (ASTM 1)	200 g (ASTM 4)/ 5000 g (ASTM 4)

<sup>2)</sup> in the temperature range 10 °C ... 30 °C

<sup>3)</sup> determined at 5% load, k = 2

## 10.2 Dimensions

Dimensions in mm.

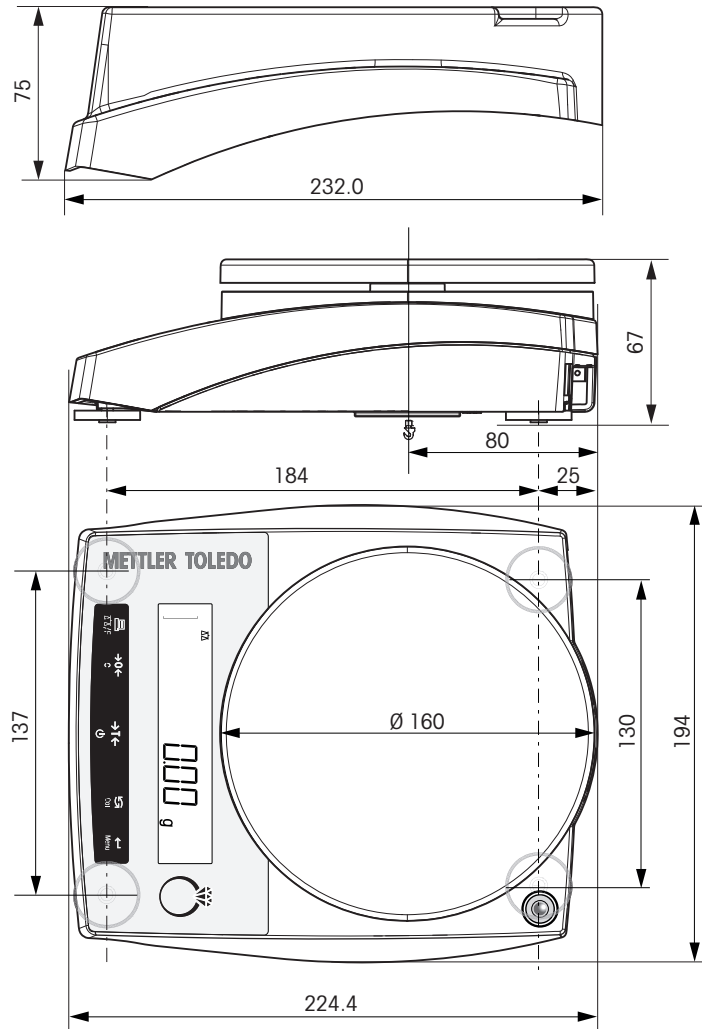

## 10.3 Interface specifications

### 10.3.1 RS232C interface

Each balance is equipped with a RS232C Interface as standard for the attachment of a peripheral device, e.g., a printer or a computer.

Schematic	Item	Specification
	Interface type	Voltage interface according to EIA RS232C/ DIN66020 CCITT V24/V.28)
	Max. cable length	15 m
	Signal level	Outputs: +5 V ... +15 V (RL = 3–7 kΩ) –5 V ... –15 V (RL = 3–7 kΩ) Inputs: +3 V ... +25 V –3 V ... –25 V
	Connector	Sub-D, 9-pole, female
	Operating mode	Full duplex
	Transmission mode	Bit-serial, asynchronous
	Transmission code	ASCII
	Baud rates	600, 1200, 2400, 4800, 9600, 19200, 38400 (software selectable)
	Bits/parity	7-bit/none, 7-bit/even, 7-bit/odd, 8-bit/none (software selectable)
	Stop bits	1 stop bit
	Handshake	None, XON/XOFF, RTS/CTS (software selectable)
	End-of-line	<CR><LF>, <CR>, <LF> (software selectable)
	Power supply for 2nd display	+ 12 V, max 40 mA (software selectable, 2nd display mode only)

### 10.3.2 MT-SICS interface commands and functions

Many of the instruments and balances used have to be able to integrate into a complex computer or data acquisition system.

To easily integrate a balance into a system and utilize its capacity to the full extent, most balance functions are also available as corresponding commands via the data interface.

All new METTLER TOLEDO balances launched on the market support "METTLER TOLEDO Standard Interface Command Set" (MT-SICS). The commands available depend on the functionality of the balance.

For further information, please contact your METTLER TOLEDO representative.





Refer to the MT-SICS Reference Manual.

► [www.mt.com/library](http://www.mt.com/library)

## 11 Accessories and Spare Parts

### 11.1 Accessories

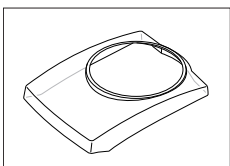
	Description	Order no.
<b>Printers</b>		
	RS-P28/11 printer with RS232C connection to balance (with date, time and applications)	11124309
	Paper roll (length: 20 m), set of 5 pcs	00072456
	Paper roll (length: 13 m), self-adhesive, set of 3 pcs	11600388
	Ribbon cartridge, black, set of 2 pcs	00065975
<b>Cables for RS232C interfaces</b>		
	RS9 – RS9 (m/f): connection cable for PC, length = 1 m	11101051
	RS9 – RS25 (m/f): connection cable for PC, length = 2 m	11101052
	USB-RS232 cable (to connect a balance via RS232C to a USB port)	64088427
<b>Auxiliary displays</b>		
	RS232 auxiliary display AD-RS-J7	12122380
	RS232 auxiliary display with backlit RS-AD-L7	72213564
<b>Protective covers</b>		
	Protective cover	12102980

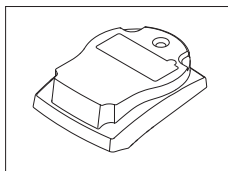

Stackable cover

30079407

**Software**



EasyDirect Balance is an application software to collect, analyze, store and export balance measurement and device data on PC.

License EasyDirect Balance for 10 Instruments

30540473

License EasyDirect Balance for 3 Instruments

30539323

**Transport cases**



Transport case for portable models (PL-E, JL-GE)

12102982

**Various**

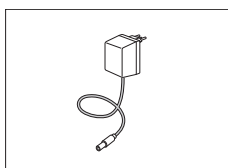

AC/DC universal adapter (EU, USA, AU, UK) 100–240 VAC, 50/60 Hz, 0.5 A, 12 VDC 1 A

11120270

**Adjustment weights**

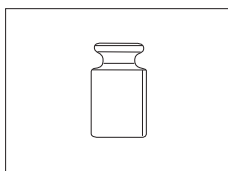

OIML / ASTM weights (with calibration certificate) see [www.mt.com/weights](http://www.mt.com/weights)

**11.2 Spare parts**

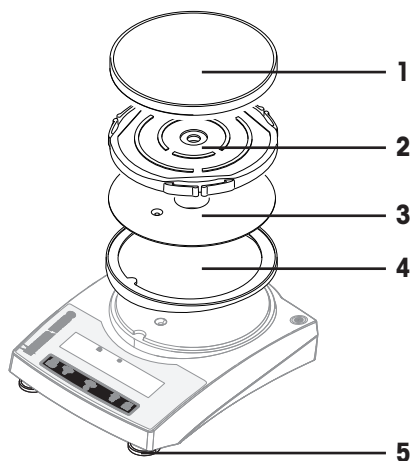



	<b>Order no.</b>	<b>Designation</b>	<b>Remarks</b>
<b>1</b>	12102941	Weighing pan ø 160 mm	–
<b>2</b>	12102944	Pan support for weighing pan ø 160 mm	–
<b>3</b>	12102948	EMC plate	–
<b>4</b>	12120338	Adapter ring	–
<b>5</b>	12102923	Leveling foot	–

## 12 Disposal

In conformance with the European Directive 2012/19/EU on Waste Electrical and Electronic Equipment (WEEE) this device may not be disposed of in domestic waste. This also applies to countries outside the EU, per their specific requirements.

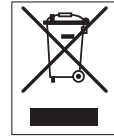

Please dispose of this product in accordance with local regulations at the collecting point specified for electrical and electronic equipment. If you have any questions, please contact the responsible authority or the distributor from which you purchased this device. Should this device be passed on to other parties, the content of this regulation must also be related.

### **Battery disposal**

Batteries contain heavy metals and therefore cannot be disposed of in the normal refuse.

- Observe local regulations on the disposal of materials that are hazardous to the environment.

# Index

## Numerics

1/10 d 23

## A

AC/DC adapter 56  
Accessories 61  
Adapter ring 7  
Adjusting 17  
Adjustment 25  
Advanced menu 22  
altitude 56  
Antitheft device 7  
Application check weighing 36  
Application division factor weighing 44  
Application icons 9  
Application multiplication factor weighing 42  
Application percent weighing 34  
Application piece counting 31  
Application statistics 38  
Application totaling 40  
Application weighing 17  
Applications 9  
Auto print 28  
Automatic standby 26  
Automatic zero setting 26  
Autozero 26  
Average (Statistics) 38

## B

Backlight 26  
Basic menu 22, 23  
Basic principles for operation 9  
Battery operation 13  
Baudrate 29  
Below-the-balance weighing 19  
Bit/Parity 29

## C

Calibration 25  
Cancel 11  
Change settings 10  
Char set 30  
Check weighing 36  
Cleaning 49  
Closing the menu 11  
compliance information 4

convention 3

## D

Data communication format 28  
Date 23  
Date format 25  
dimension 59  
Display 27  
Display increment 23  
Display panel 9  
disposal 64  
Division factor weighing 44

## E

EasyDirectBalance 47  
End of line 30  
Environment 25  
environmental condition 12, 56  
External weight 17

## F

Factor weighing 42, 44  
Function PC-Direct 46

## H

Handshake 30  
Header 27  
Host 27  
humidity 56

## I

Icons 9  
Identification 24  
Input principle 11  
install  
    site 12  
Interface  
    MT-SICS 60  
Interface menu 22, 27  
Interface RS232C 27, 60  
Interval 30  
Introduction 3

## K

Key functions 8

## L

Level indicator 16

Leveling	16	Select menu	10
Leveling the balance	16	Select menu topic	10
Line feed	28	Selection of applications	9
location	12	Service	26, 49
<b>M</b>		Service date reset	26
Main menu	23	Service icon	26
Manual adjustment with external weight	17	Service reminder	26
Materials	56	Set identification	24
Menu	23	Signature line	28
Menu advanced	22	Simple weighing	9
Menu basic	22, 23	Single	28
Menu interface	22, 27	Spare parts	63
Menu operation	9	Stackable cover	21
Menu protection	23	Standard deviation (Statistics)	38
Menu topic	10	Standby	26
MT-SICS	60	Statistics	38
Multiplication factor weighing	42	Status icons	9
<b>N</b>		Stop bit	30
Net	18	Submenu	10
Numerical values	11	Switching	
<b>O</b>		On	15
Operating temperature	15	Switching weight units	19
Operation keys	8	symbol	3
<b>P</b>		warning	5
PC software	47	<b>T</b>	
PC-DIR	27	Taring	18
PC-Direct	46	Technical data	56
Percent weighing	34	temperature	56
Performing a simple weighing	18	Terminating a current application	10
Piece counting	31	Time	23
Power supply	56	Time format	25
see AC/DC adapter	56	Topic	10
Print	19	Totaling	40
Print menu	24	Transmit data	19
Printer	27	Transport over short distances	20
Protect	23	Transporting the balance	20
<b>R</b>		<b>U</b>	
Recall	19, 26	Unit	24
Reset	24	<b>W</b>	
RS232C interface	27, 60	Warm-up time	15
<b>S</b>		warning symbol	5
Safety information	5	Weighing application	9
Saving settings	11	Weighing made simple	17
		Weighing mode	9
		Weighing pan	7

Weighing-in aid	19
Weight unit	19, 24

## **Z**

---

Zero print	28
Zero setting	18
Zeroing	26





# GWP®

Good Weighing Practice™

---

GWP® is the global weighing standard, ensuring consistent accuracy of weighing processes, applicable to all equipment from any manufacturer. It helps to:

- Choose the appropriate balance or scale
- Calibrate and operate your weighing equipment with security
- Comply with quality and compliance standards in laboratory and manufacturing

 [www.mt.com/GWP](http://www.mt.com/GWP)

[www.mt.com/jewelry](http://www.mt.com/jewelry)

For more information

**Mettler-Toledo GmbH**

Im Langacher 44  
8606 Greifensee, Switzerland  
[www.mt.com/contact](http://www.mt.com/contact)

Subject to technical changes.  
© Mettler-Toledo GmbH 12/2020  
30130488F en



30130488